

Academia

FURNITURE INDUSTRIES



School Furniture Catalog

Create An **Ideal Learning Environment**

With Flexible, Collaborative Classroom Furniture.

Promise & Philosophy

Discover Academia Furniture's unique style for the 21st century classroom - fun, vibrant, colorful, comfortable & versatile.

Our Promise: To exceed your expectations in innovative classroom furniture by personally and helpfully servicing your every need promptly in a true relationship-based association.

Our philosophy: To provide what we promise, when we promise, at a competitive price.



We Design Innovative Products

Making you look good makes us proud. Design, safety, utility, comfort, stability and durability are just the start. Colors, shapes, sizes, finishes, gliding or immobile - the choices abound.

From prestigious public schools to new charter schools, students, teachers and administration are delighted with Academia's quality and versatility. Let's see how good we can make you look.



Environmentally Conscious



Earning 100% compliance with the most stringent standards by recognized independent testing agencies, Academia goes further by reducing our environmental footprint and constantly testing to ensure that all products are classroom-safe and kid-friendly (MAS Certified Green and LEED compliant).



15-Year Warranty

Academia Furniture Industries offers the original user a limited fifteen-year warranty against all manufacturing defects in material and workmanship from date of purchase.



Scan to Learn About Us

New Featured Items



Student Desk
Synco Series - PAGE 44



Classroom Table
Forte Series - PAGE 102

New Laminate
Option 'Enrich'



Classroom Table
Forte Series - PAGE 102

School Seating 4-21

Size & Ordering Information 20-21

Soft Seating 22-39

Size & Ordering Information 38-39

Student Desk 40-69

Size & Ordering Information 68-69

Combo Desk 70-85

Size & Ordering Information 82-85

Teacher Desk 86-99

Size & Ordering Information 98-99

Classroom Table 100-129

Size & Ordering Information 126-129

Media Center 130-143

Size & Ordering Information 142-143

Essentials 144-148

Size & Ordering Information 148

Designers Portal 149

Install Showcase 150-151

Guides 152-157

NEW Available
Edges



X-Strong



PVC 3mm



For more information see page 154



EDWARD H. BRYAN SCHOOL - CRESSKILL, NJ



Zed Series – School Chair
Squirrelle® – Active Seating Stool
The Mod Series® – Soft Seating
Harmony Series – Chord Table
Hercules Series – Half Round Table
STAX Bookcase – Single Sided Bookcase

Zed Series – School Chair



Created to answer every education seating need, based on extensive research.

Extreme comfort, striking contours and sleek, extra-wide back and seat - fits all children and adults.

Astounding hybrid engineering - injection and blow mold - minimizes internal stress for longest wear.

Gas-assisted injection produces lightweight, blemish-free, cosmetically perfect surface.

Zed STYLES



Z28 - Value Chair



Z18VBB - Standard Chair with Bookbasket



Z28C - Value with Casters



Z68 - Cantilever Chair



Z58 - Computer Chair



Z58D - Drafting Stool

Zed Series – School Chair



Z68 - Cantilever Chair

SEAT

Shell: Color-Impregnated Polypropylene Injection and Gas Assist Molded Plastic with Built-In Carry Handle

Back: Smooth and Secure Shell Back

FRAME

Standard & Value Chair*: Chrome-Plated 1" Round, 16-Gauge Steel

Bookbasket (WBB): Chrome-plated ¼" rod steel: 14½"W × 12"D × 8"H. (Only Available on Chrome-Plated Frame Standard & Value Chair)

Boots (Standard Chair Only): Color-Impregnated Polypropylene Plastic

Glides: Self-Adjusting Nylon

Cantilever Chair*: 12-gauge steel legs. Rubber bumpers to protect and grip the table top.

Glides & Inserts: Color coordinated injection molded sled base glide housing to accommodate a choice of four glide inserts; nylon, felt, steel or rubber. Select finish at the time of ordering.

Computer Chair/Drafting Stool: Pneumatic Lift, Adjustable Gas Lift Cylinder, and 5-Star Plastic Swivel Base on Five Casters (Stationary Glides are Optional)

Drafting Stool Only: Chrome-Plated Foot Ring

Casters: Must be installed on-site.

*Standard, Value & Cantilever Chair Available in Gray (G) Powder Coating or Black (B) Powder Coating



Underseat Rivets

Smooth Back

NEW
Black Frame Powder Coat



Carry Handle

3 Frame Color Options Available



Flex of Back

Optional Items: Glide Caps (Felt, Rubber and Steel), Stationary Bell Glides (for 5-Star Swivel Computer Chairs) can be requested instead of Casters at the time of ordering.

Inspiration Series – School Chair



This design incorporates the latest looks, trends and colors to enhance any modern classroom environment. Stackable to eight chairs high.

The dual curves and flex action of the back provide exceptional support.

16-gauge steel mated to strong, yet flexible polypropylene plastic shells, capped off with self-adjusting glides.

From the built-in carry handle, to the chrome-plated steel to the color-coordinated boots, these chairs truly are an Inspiration.

Inspiration STYLES



618 - Standard Chair



718 - Value Chair



718C - Value Chair with Casters



718SB - Sled Base Chair



658X - Computer Chair
(Shown with optional stationary bell glide)



658D - Drafting Stool

Inspiration Series – School Chair



688 - Cantilever Chair

SEAT

Shell: Color-Impregnated Polypropylene Molded Plastic with Built-In Carry Handle

Back: Integral Lumbar Supports

Pads (P): Available on chairs 16" and above. Available in Black, Burgundy, Navy and Custom.

FRAME

Standard & Value Chair: Chrome-Plated, 1" Round, 16-Gauge Steel

Bookbasket (WBB): Chrome-plated ¼" rod steel: 14½"W × 12"D × 8"H.

Boots (Standard Chair Only): Color-Impregnated Polypropylene Plastic

Glides: Self-Adjusting Nylon

Sled-Base Chair: 16 - gauge chrome-plated steel.

Cantilever Chair: 12-gauge steel legs.

Cantilever X-Plus: ¾" added steel tube for leg support and larger shell for added support.

Glides & Inserts: Color coordinated injection molded sled base glide housing to accommodate a choice of four glide inserts; nylon, felt, steel or rubber. Select finish at the time of ordering.

Computer Chair/Drafting Stool: Pneumatic Lift, Adjustable Gas Lift Cylinder, and 5-Star Plastic Swivel Base on Five Casters (Stationary Glides are Optional)

Drafting Stool Only: Chrome-Plated Foot Ring

X-Plus(X): Larger shell and Frame for added weight capacity available.

Casters: Must be installed on-site.



Flex of Back

Underseat Rivets



Carry Handle



Back with Ribs

Optional Items: Glide Caps (Felt, Rubber and Steel), Stationary Bell Glides (for 5-Star Swivel Computer Chairs) can be requested instead of Casters at the time of ordering.

Classic Series – School Chair



Our classic school chair offers a waterfall seat with a curved back, supporting students of all sizes.

In any classroom old or new, our curved seat and vented back offer a timeless design.

Heavy-duty polypropylene shell seat, with 1½" diameter round steel legs, which are 18-gauge chrome-plated. Available in 5 sizes with self-adjusting glides.

Side by side tubular steel back supports, seatback ribs and 14-gauge underseat brackets.

Classic STYLES



128WBB - Chair with Bookbasket



128C - Chair with Casters



128M - Music Chair



128SB - Sled-Base Chair



158P - Computer Chair with Pads



158D - Drafting Stool

Classic Series – School Chair



128 - 18" Classic Chair

SEAT

Shell: Injection-Molded Polypropylene Plastic with Built-In Supports and Waterfall Front

Back: Vented Back

Pads (P): Available on chairs 16" and above. Available in Black, Burgundy, Navy and Custom.

FRAME

Frame: 1½" Round, 18-Gauge Chrome-Plated Steel (1" Round For 12" & 14" Chairs)

Back Support: ¾" Round, 16-Gauge Chrome-Plated Steel

Underseat Brackets: Two 14-Gauge, Plated Steel

Bookbasket (WBB): Chrome-plated ¼" rod steel: 14½"W × 12"D × 8"H.

Glides: Self-Adjusting Nylon

Sled-Base Chair: ¾" round 16-gauge chrome-plated steel.

Computer Chair/Drafting Stool: Pneumatic Lift, Adjustable Gas Lift Cylinder, and 5-Star Plastic Swivel Base On Five Casters (Stationary Glides are Optional)

Drafting Stool Only: Chrome-Plated Foot Ring

Casters: Must be installed on-site.



Steel Back Supports



Waterfall Edge Front



14-Gauge Underseat Steel

Optional Items: Glide Caps (Felt, Rubber and Steel), Stationary Bell Glides (for 5-Star Swivel Computer Chairs) can be requested instead of Casters at the time of ordering.

Size & Order Info
See pages 20-21

Colors, Guides,
& Accessories
See pages 152-157

Hard Plastic Series – School Chair



Contoured seat shaped to follow natural body lines; back is designed to support students.

14-gauge steel back support on 16", 18" and 19"; 16-gauge on lower heights.

16-gauge steel legs mated to 3/8" thick hard-plastic seat and back.

Designed for optimal back support and for secure upside down stacking on desks.

Hard Plastic STYLES



518 - 18" Hard Plastic Chair



518WBB - Chair w/ Bookbasket



518C - Chair w/ Casters



558 - Computer Chair



558D - Drafting Stool

Hard Plastic Series – School Chair



518 - 18" Hard Plastic Chair

SEAT

Back: 3/8" Thick Hard-Plastic 13 1/2" W X 6 3/8" L

Seat: 3/8" Thick Hard Plastic

FRAME

Frame: 1" Round, 16-Gauge Chrome-Plated Steel Welded Frame

Back Support: 3/4" Round, 14-Gauge Chrome-Plated Steel (16-Gauge For 10-14")

Bookbasket (WBB): Chrome-plated 1/4" rod steel: 14 1/2"W x 12"D x 8"H.

Glides: Self-Adjusting Nylon

Computer Chair/Drafting Stool: Pneumatic Lift, Adjustable Gas Lift Cylinder, and 5-Star Plastic Swivel Base On Five Casters (Stationary Glides are Optional)

Drafting Stool Only: Chrome-Plated Foot Ring

Casters: Must be installed on-site.



Gooseneck Back Supports

Unitized Frame with
6 Point Weld

Underside of Chair

Optional Items: Glide Caps (Felt, Rubber and Steel). Stationary Bell Glides (for 5-Star Swivel Computer Chairs) can be requested instead of Casters at the time of ordering.

Educational Series – Lab Stool



The seats are screwed to large underseat plates which are welded to the frame for durability.

Ideal for science labs, kitchens and art rooms, these stools are strong, stable and easy-to-clean.

Our current design features a wider footprint for added stability.

Students are sure to find a comfortable position since these stools are available with fixed or adjustable height legs.

Educational STYLES



Adj. Ht.
4518A - Hard Plastic Stool



Fix. Ht.
4530 - Hard Plastic Stool



Adj. Ht.
4518AWB - Hard Plastic Stool
with Back Support



Fix. Ht.
4530WB - Hard Plastic Stool
with Back Support

Educational Series – Lab Stool



Adj. Ht.
4518AWB - Hard Plastic Stool
with Back Support

SEAT

Back (Seat Back Stool Only): 5/8" Thick Hard-Plastic
13 1/8"W x 6 3/8"L

Seat: 5/8" Thick Hard-Plastic 13" Diameter

FRAME

Frame: Chrome-Plated 7/8" 18-Gauge

Adj. Ht. Stool (4518A & 4518AWB only):
3/4" 18-gauge with Two Self-locking Screws. 18-27" Ht

Back Support (Seat Back Stool Only): 3/4" Round,
14-Gauge Chrome-Plated Steel Welded To Bottom
Frame

Foot Ring: 18-Gauge 3/4" Outer-Diameter

Glides: Self-Adjusting Nickel-Plated Casing With
Nylon Inserts



Waterfall
Edge

Wide Footprint



Welds at Foot Ring

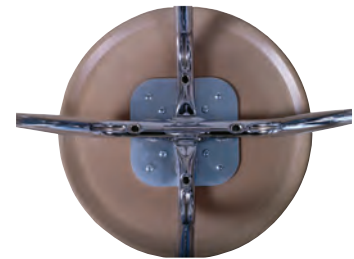

Welded Steel Frame and Plate

Optional Items: Glide Caps (Felt, Rubber and Steel).



METZ MIDDLE SCHOOL - MANASSAS, VA



Hercules Series – Adam Table
 Squircle® – Active Seating Stool
 The Mod Series® – Soft Seating
 Boost Series – Round & Oval Café Table
 STAX Bookcase – Single Sided Bookcase
 STAX Curved Bookcase – Single Sided Bookcase
 Zed Series – School Chair & Boost Café Stool

Squircle® – Active Seating Stool



Appealing addition to any learning environment: classrooms, libraries or lounges. Comes in 13 colors & 4 height options - 3 fixed plus 1 adjustable.

Adjustable Squircle® has the same impressive aesthetics with a large handle for easy adjustability.

Waterfall edge seat doubles as grab handle; lightweight for easy mobility; soft, durable foam seat.

The Squircle® allows students to safely release energy with a unique dome base angled to sway securely in every direction.

Squircle® STYLES



SQA- 15½" - 19½"



SQ-18 - 18"



SQ-15 - 15"



SQ-13 - 13"

Squircle® – Active Seating Stool



SQ-18 - Active Seating Stool

SEAT

Seat Top: Polypropylene & Foam Center. Waterfall Edge Seat Doubles as Grab Handle. 12½"D

BASE

Rubber Base: Shaped to wobble, not topple, with rubber overmold, nonslip protection that ensures feet rest firmly on chair.

Angled Base: 13"

Fixed Ht. Option: 18", 15" and 13"

Adjustable Ht. Option: Adjusts 15½"-19½"



SQ-18 & HS-3152CD - Active Seating Stool & Harmony Chord Table



SQ-18 & HL-4848SQ - Active Seating Stool & Hercules Square Table



Comfortable Foam Center

Shown In: Harmony Chord Table - Gray Graphite Chem Res HPL Gray Graphite. Hercules Square Table - Chem Res HPL and X-Strong Edge

"Squircle" is a registered trademark of Academia Furniture Industries.

<p>Size & Order Info See pages 20-21</p> 	<p>Colors, Guides, & Accessories See pages 152-157</p> 
--	--



Zed Series – School Chair

Seat Ht."	W × D"	Frame Color		
		Chrome	Gray PC*	Black PC*
Standard				
12"	12¾ × 12"	Z12	Z12G	Z12B
14	12¾ × 12	Z14	Z14G	Z14B
16	17 × 16	Z16	Z16G	Z16B
17½	17 × 16	Z18	Z18G	Z18B
18½	17 × 16	Z19	Z19G	Z19B
Standard w/ Bookbasket				
14	12¾ × 12"	Z14WBB	—	—
16	17 × 16	Z16WBB	—	—
17½	17 × 16	Z18WBB	—	—
18½	17 × 16	Z19WBB	—	—
Value				
12"	12¾ × 12"	Z22	Z22G	Z22B
14	12¾ × 12	Z24	Z24G	Z24B
16	17 × 16	Z26	Z26G	Z26B
17½	17 × 16	Z28	Z28G	Z28B
18½	17 × 16	Z29	Z29G	Z29B
Value w/ Bookbasket				
14	12¾ × 12"	Z24WBB	—	—
16	17 × 16	Z26WBB	—	—
17½	17 × 16	Z28WBB	—	—
18½	17 × 16	Z29WBB	—	—
Cantilever Chair				
12"	12¾ × 12"	Z62	Z62G	Z62B
14	12¾ × 12	Z64	Z64G	Z64B
16	17 × 16	Z66	Z66G	Z66B
18	17 × 16	Z68	Z68G	Z68B
19	17 × 16	Z69	Z69G	Z69B
Casters				
16"	17 × 16"	Z26C	Z26CG	Z26CB
18	17 × 16	Z28C	Z28CG	Z28CB
Casters w/ Bookbasket				
16"	17 × 16"	Z26CWBB	—	—
18	17 × 16	Z28CWBB	—	—
Computer Chair				
17-23"	17 × 16"	Z58	—	—
Drafting Stool				
24-33"	17 × 16"	Z58D	—	—
Boost Café Stools				
24"	19½ × 22½"	Z424	Z424G	Z424B
30	19½ × 22½"	Z430	Z430G	Z430B

*Powder Coating: Not available with Bookbasket (WBB), Computer Chair and Drafting Stool.

Optional Items: Glide Caps (Felt, Rubber and Steel), Stationary Bell Glides (for 5-Star Swivel Computer Chairs) can be requested instead of Casters at the time of ordering.



Inspiration Series – School Chair

Seat Ht."	W × D"	Frame Color
		Chrome
Standard		
11½"	12¼ × 12"	612
13½	12¼ × 12	614
16¼	16 × 16	616
17¾	16 × 16	618
17¾	17¾ × 16	618X
19	16 × 16	619
18½	17¾ × 16	619X
Value		
11½"	12¼ × 12"	712
13½	12¼ × 12	714
16¼	16 × 16	716
17¾	16 × 16	718
17¾	17¾ × 16	718X
19	16 × 16	719
18½	17¾ × 16	719X
Standard w/ Bookbasket		
13½	12¼ × 12"	614WBB
16¼	16 × 16	616WBB
17¾	16 × 16	618WBB
17¾	17¾ × 16	618XWBB
19	16 × 16	619WBB
18½	17¾ × 16	619XWBB
Value w/ Bookbasket		
13½	12¼ × 12"	714WBB
16¼	16 × 16	716WBB
17¾	16 × 16	718WBB
17¾	17¾ × 16	718XWBB
19	16 × 16	719WBB
18½	17¾ × 16	719XWBB
Cantilever Chair		
12"	12¼ × 12"	682
14	12¼ × 12	684
16¼	16 × 16	686
18	16 × 16	688
18	17¾ × 16	688X
19	16 × 16	689
19½	17¾ × 16	689X
Casters		
16¼	16 × 16"	716C
19½	16 × 16	718C
Sled Base		
18	16 × 16"	718SB
Computer Chair		
17-23"	16 × 16"	658
17-23	17¾ × 16	658X
Drafting Stool		
24-33"	16 × 16"	658D
24-33	17¾ × 16	658XD
Boost Café Stools		
24"	19½ × 22½"	7424
30	19½ × 22½"	7430

For Pads (P)* add Suffix to the Model Number Above
P

*Pads (P): Available on chairs 16" and above. Available in Black, Burgundy, Navy and Custom.

Optional Items: Glide Caps (Felt, Rubber and Steel), Stationary Bell Glides (for 5-Star Swivel Computer Chairs) can be requested instead of Casters at the time of ordering.

Bookbasket (WBB) must be installed by manufacturer. • All heights listed are within ¾" variants.

Classic Series – School Chair



Seat Ht."	W x D"	Model
11¾"	13 x 12"	122
14	13 x 12"	124
16½	16¼ x 15"	126
18¼	16¼ x 15"	128
19¼	16¼ x 15"	129
w/ Bookbasket		
14	13 x 12"	124WBB
16½	16¼ x 15"	126WBB
18¼	16¼ x 15"	128WBB
19¼	16¼ x 15"	129WBB
Casters		
16"	16¼ x 15"	126C
18	16¼ x 15"	128C
Music Chair		
17¾"	16¼ x 15"	128M
Sled Base		
18"	16¼ x 15"	128SB
Computer Chair		
17-23"	16¼ x 15"	158
Drafting Stool		
24½-29½"	16¼ x 15"	158D
For Pads (P)* add Suffix to the Model Number Above		
P		

*Pads (P): Available on chairs 16" and above. Available in Black, Burgundy, Navy and Custom.

Optional Items: Glide Caps (Felt, Rubber and Steel), Stationary Bell Glides (for 5-Star Swivel Computer Chairs) can be requested instead of Casters at the time of ordering.

Hard Plastic Series – School Chair



Seat Ht."	W x D"	Model
12½-15½"	13½ x 13"	510A
12	13½ x 13"	512
14	13½ x 13"	514
15¾	15¾ x 15"	516
17¾	15¾ x 15"	518
18¾	15¾ x 15"	519
w/ Bookbasket		
14	13½ x 13"	514WBB
15¾	15¾ x 15"	516WBB
17¾	15¾ x 15"	518WBB
18¾	15¾ x 15"	519WBB
Casters		
18¾"	15¾ x 15"	518C
Computer Chair		
17-23"	15¾ x 15"	558
Drafting Stool		
24½-29½"	15¾ x 15"	558D

Optional Items: Glide Caps (Felt, Rubber and Steel). Stationary Bell Glides (for 5-Star Swivel Computer Chairs) can be requested instead of Casters at the time of ordering.

Bookbasket (WBB) must be installed by manufacturer. • All heights listed are within ¼" variants.

Educational Series – Lab Stool



Seat Ht."	W x D"	Model
Hard Plastic		
18-26"	14 x 14"	4518A
18	14 x 14"	4518F
24	16 x 16"	4524
30	18 x 18"	4530



Seat Ht."	W x D"	Model
Seat Back		
18-24"	14 x 14"	4518AWB
18	14 x 14"	4518FWB
24	16 x 16"	4524WB
30	18 x 18"	4530WB

Optional Items: Glide Caps (Felt, Rubber and Steel).

Squirrel® – Active Seating Stool



Seat Ht."	W x D"	Model
Active Seating Stool		
13"	13 x 13"	SQ-13
15	13 x 13"	SQ-15
18	13 x 13"	SQ-18
15½-19½"	13 x 13"	SQA

Size Chart

Approximate Chair Size Suggestions

Ht. of Chair Seat	12"	14"	16"	18"	19"
Preschool - K	•	•			
Grade 1		•			
Grade 2		•	•		
Grade 3			•		
Grade 4			•	•	
Grade 5 - 12				•	•



ROUND ELEMENTARY SCHOOL - MANASSAS, VA



Zed Series – School Chair
Hercules Series – Square Table
Re*Group Series – Soft Seating
The Mod Series® – Soft Seating
STAX Bookcase – Single Sided Bookcase
STAX Curved Bookcase – Single Sided Bookcase



The ultimate in soft-seating with every possible component to build your unparalleled dream arrangement.

Re•Group defines versatility – if you can imagine it, Re•Group can create it. Any choice of shape, color and pattern – wait for the Wows.

Impeccable craftsmanship, angled bolsters for comfort and character, accessible power ports and solid low profile for personal safety.

Long-lasting wood frame, incredibly resilient foams and fabrics, upholstered with French triple seams to ensure endurance.

Re•Group STYLES



REB36 - Bench with Back



REB42 - Bench with Back

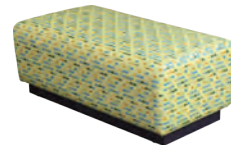

RE42 - Bench



RE26-O - Outside Corner



RE28-I - Inside Corner

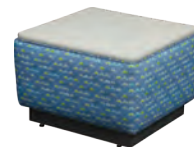

RE24-LAM - Ottoman

Re•Group Series

SEATING

Seat and Back: Polyurethane foam surrounds a 3/4" plywood frame supported by multiple 1 x 2 wooden pegs.

Textiles: 6 different grade options

Glides: Adjustable 1" glide

Base: 3" powder-coated textured steel base.

Ottoman

Tabletop: 3/4" laminate top

Edge Banding: PVC T-mold edge banding with any of our standard colors

Glides: Adjustable 1" glide



Configuration Setup
with 8138-LAM - 30" Round Mod® with Power Port



RE86 - Chaise Lounge



RE26-O Outside and RE28-I Inside
Corner with RE-SHF Power Shelf



RE-SHF - Shelf



Side Profile with
Flush Power Port



Laminate Ottoman with
Signature Welt Piping



Underside Base and Glide
with Standard Ganging



UNIVERSIDAD DE PUERTO RICO, RECINTO DE CAYEY - CAYEY, PR



The Mod Series® – Soft Seating
Boost Series – Round Café Table
Inspiration Series – School Chair & Café Stool

The Mod Series® – Basic Mod® Shapes



Cushiony and cozy, the high density foam provides a welcome soft-seating change from traditional chairs.

Pair Mod® with café tables, Mod® tables, or 30" Round Mod® with laminate top.

Available in six Momentum Textiles grade choices, including pen-resistant, water resistant, and antibacterial options.

Various shapes, different height options, and limitless configurations.

The Mod Series® STYLES

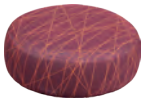

8104 - Pebble Mod®



8118 - Round Mod®



8318 - Square Mod®



8418 - Square Corner Mod®



8518 - Hexagon Mod®



8538 - Large Hexagon Mod®

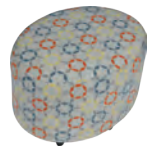

8128 - Oval Mod®



8138-LAM - 30" Round Mod® with Laminate Top
(Shown with Power Port)



8138-LAM - 30" Round Mod® with Laminate Top
8218 - Semi Round Mod®



8328 - Trapezoid Mod®



8618 - Rectangular Mod®



8030R - Mod® Table
(Shown with Laminate Driftwood)

The Mod Series® – Basic Mod® Shapes



8538 - Large Hexagon Mod®

SEATING

Basic Mod® Shape

Seat: Polyurethane foam surrounds a ¾" plywood frame supported by multiple 1 × 2 wooden pegs

Textiles: 6 Different Grade Options

Casters/Glides: Compatible with 1 ½" twin casters or stationary rubber glides. See pages 38-39 for details.

Pebble Mod® Shape

Seat: Polyurethane Foam Core With ½" Plywood Base

Nail Glides: Underneath Pebble

MOD® TABLE

Tabletop: High Pressure Laminate

8020SQ Square Mod® Table: 22 × 22" Top

Edge Banding: PVC 3mm edge banding; Standard in White.

8030R Round Mod® Table: 30" R Top

Edge Banding: Hydraulically inserted T-mold edge banding; Color edge band available.

Frame: 1" Square 18 Gauge Welded Steel

Glides: Height Adjustable Glides

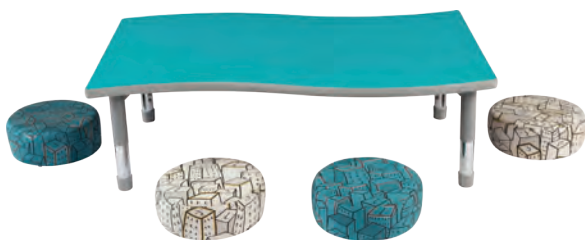

8104 - (4) Pebble Mod®

(Shown with HSSUS-3152CD - Harmony Series Chord Table in Sushi Ht.)



Inner Pebble Mod Frame



French Stitching

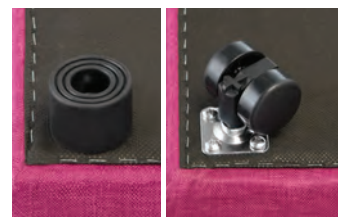

Glide

Caster

Optional Items: Stationary Glides

"The Mod Series" & "Mod" are registered trademarks of Academia Furniture Industries.

Size & Order Info
See pages 38-39

Colors, Guides,
& Accessories
See pages 152-157



The Mod Series® – Mod® with Back



Comfortable seat and back, the high density foam provides a welcome soft-seating change from traditional chairs.

Configure in groups; mix & match; the possibilities are endless.

Available in six Momentum Textiles grade choices, including pen-resistant, water resistant, and antibacterial options.

Various shapes, different height options, and limitless configurations.

The Mod Series® STYLES



8848 - Outside Corner Mod®,
8818 - 2 Step Mod® &
8838 - Inverted Corner Mod®



8828 - 3 Step Mod®

The Mod Series® – Mod® with Back

SEATING

Seat: Polyurethane foam surrounds a ¾" plywood frame supported by multiple 1 × 2 wooden pegs

Textiles: 6 Different Grade Options

Nail Glides: Underneath 2 Step, 3 Step, Outside Corner & Inside Corner

Legs: Available on 1/4 Back & 3/4 Back Only.
Brushed steel, 2¼ Dia. x 5"H



Configure in Groups

8848 - Outside Corner Mod®, 8818 - 2 Step Mod® & 8838 - Inverted Corner Mod®



French Stitching



Nail Glide

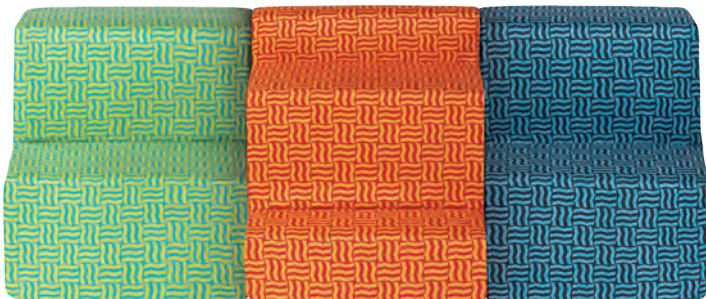

Configure in Groups

(8818 - 2 Step Mod® & 8828 - 3 Step Mod®)



Inner Mod Frame

"The Mod Series" & "Mod" are registered trademarks of Academia Furniture Industries.

Size & Order Info
See pages 38-39

Colors, Guides,
& Accessories
See pages 152-157



MOMENTUM GROUP

Academia
FURNITURE INDUSTRIES
www.academiafurniture.com



UNIVERSIDAD DE PUERTO RICO, RECINTO DE CAYEY - CAYEY, PR



Inspiration Series – Boost Café Stool
The Mod Series® – Arc 4 Mod® with Backrest & Shelf
The Mod Series® – 30" Round Mod® with Laminate Top

The Mod Series® – Arc Mod®



Cushiony and cozy, the high density foam provides a welcome soft-seating change from traditional chairs.

Pair Mod® with café tables, Mod® tables, or 30" Round Mod® with laminate top.

Available in six Momentum Textiles grade choices, including pen-resistant, water resistant, and antibacterial options.

Various shapes, different height options, and limitless configurations.

The Mod Series® STYLES



8717 - Arc 4 Mod® with Backrest

+



8708 - Mega 4 Mod®

=



Create a 2nd side on a "couch" (8717 & 8708 - Arc 4 Mod® Combo)



8717-SHELF - Arc 4 Mod® with Backrest & Shelf



8718 - Arc 4 Mod® with CF-30R - Café Table



8728 - Arc 6 Mod® with 80205Q - Mod® Table

The Mod Series® – Arc Mod®

SEATING

Seat: Polyurethane foam surrounds a 3/4" plywood frame supported by multiple 1 x 2 wooden pegs

Textiles: 6 Different Grade Options

Casters/Glides: Compatible with 1 1/2" twin casters or stationary rubber glides. See pages 38-39 for details.

SHELF

Top: 5/8" Thick High-Pressure Laminate

Edge Banding: PVC 3mm edge banding. Standard Black, White or Gray Edge, Custom Colors available.

MOD® TABLE

Tabletop: High Pressure Laminate

8020SQ Square Mod® Table: 22 x 22" Top

Edge Banding: PVC 3mm edge banding; Standard in White.

8030R Round Mod® Table: 30" R Top

Edge Banding: Hydraulically inserted T-mold edge banding; Color edge band available.

Frame: 1" Square 18 Gauge Welded Steel

Glides: Height Adjustable Glides

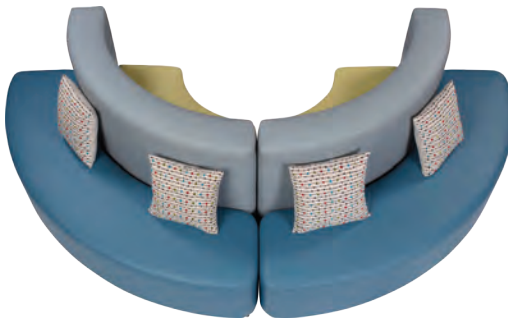

8717 & 8708 - Arc 4 Mod® Combo



Create a Horseshoe Shape
(8717 & 8708 - Arc 4 Mod® Combo)

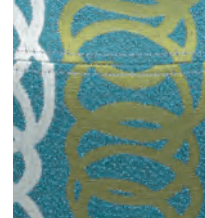

French Stitching



Glide



Caster



8717-SHELF - Arc 4 Mod® with Backrest & Shelf



8888 - Rainbow Mod®

Scan to Watch Demo



Optional Items: Stationary Glides

"The Mod Series" & "Mod" are registered trademarks of Academia Furniture Industries.

Size & Order Info
See pages 38-39

Colors, Guides, & Accessories
See pages 152-157





SYCAMORE HIGH SCHOOL - CINCINNATI, OH



Hercules Series – Rectangular Table
Inspiration Series – School Chair & Café Stool
The Mod Series® – Arc 4 Mod® with Backrest & Shelf

The Mod Series® – Basic Mod® Shapes



Seat Ht."	W × D"	Casters / Glides	Model
Mod® Table -8000			
18½"	22 × 22"	--	8020SQ*
18½"	30 × 30"	--	8030R*
Round Mod® -8100			
13½"	13 × 13"	5	8114
17½"	17 × 17"	5	8118
18"	30 × 30"	6	8138
30" Round Mod® w/ Laminate Top			
18"	30 × 30"	6	8138-LAM
Semi-Round Mod® -8200			
13½"	13 × 13"	5	8214
17½"	17 × 17"	5	8218
Square Mod® -8300			
13½"	13 × 13"	4	8314
17½"	17 × 17"	4	8318
Square Corner Mod® -8400			
13½"	13 × 13"	4	8414
17½"	17 × 17"	4	8418
Hexagon Mod® -8500			
13½"	13 × 13"	5	8514
17½"	17 × 17"	6	8518
Large Hexagon Mod® -8538			
18"	37 × 37"	6	8538
Rectangle Mod® -8600			
13½"	26 × 13"	6	8614
17½"	34 × 17"	6	8618
Pebble Mod®			
4½"	14 × 14"	4	8104
Trapezoid Mod®			
14"	36 × 18"	4	8324
18"	36 × 18"	4	8328
Oval Mod®			
14"	28¼ × 21½"	6	8124
18"	28¼ × 21½"	6	8128

The Mod Series® – Mod® with Back



Seat Ht."	W × D"	Model
2 Step Mod®		
36"	36 × 36"	8818
3 Step Mod®		
36"	36 × 36"	8828
Outside Corner Mod®		
18"	36 × 36"	8848
Inverted Corner Mod®		
18"	36 × 36"	8838



Edge Finish & Color Options

Square Mod® Table

PVC 3mm edge banding; Standard in White.

Round Mod® Table

Hydraulically inserted T-mold edge banding; Color edge band available.

See page 154 for more details.

Note the color needed at the time of ordering • All heights listed are within ¼" variants. Casters add 2-3" to the overall height.



The Mod Series® – Arc Mod®



Seat Ht."	W x D"	Casters / Glides	Model
Arc 4 -8700			
14"	56½" x 24¾"	6	8714
18"	56½" x 24¾"	6	8718
Arc 4 with Backrest			
14"	70½" x 33½"	6	8713
18"	70½" x 33½"	8	8717
Mega 4 Mod®			
14"	95 x 31½"	7	8704
18"	95 x 31½"	9	8708
Arc 6 -8700			
14"	44 x 18"	6	8724
18"	44 x 18"	6	8728
Arc 6 with Backrest			
14"	52 x 30"	5	8723
18"	52 x 30"	6	8727
Mega 6 Mod®			
14"	68½" x 23½"	7	8703
18"	68½" x 23½"	7	8707
Arc 4 Mod® with Backrest & Shelf*			
14"	70½" x 33½"	6	8713-SHELF
18"	70½" x 33½"	8	8717-SHELF
Arc 6 Mod® with Backrest & Shelf*			
14"	52 x 30"	5	8723-SHELF
18"	52 x 30"	6	8727-SHELF
Rainbow Mod®			
30"	75½" x 45"	5	8888

Optional Items: Stationary Glides on Basic & Arc Shapes Soft Seating.

"The Mod Series" & "Mod" are registered trademarks of Academia Furniture Industries.

Re•Group Series



Seat Ht."	W x D"	Model
Bench		
18"	36 x 24"	RE36
18"	42 x 24"	RE42
Bench w/ Back		
18"	36 x 24"	REB36
18"	42 x 24"	REB42
Chaise Lounge		
18"	86 x 35"	RE86
Inside Corner		
18"	28 x 28"	RE28-I
Outside Corner		
18"	26 x 26"	RE26-O
Ottoman		
16"	22 x 22"	RE24-LAM
Shelf		
29"	41 x 30"	RE36-SHF
29"	47 x 30"	RE42-SHF

Edge Finish & Color Options

<p>Arc Mod® with Backrest & Shelf PVC 3mm edge banding, Standard Black, White or Gray Edge, Custom Colors available.</p>	<p>RE24-LAM Re•Group Ottoman Hydraulically inserted T-mold edge banding; Color edge band available.</p>
---	--

See page 154 for more details.

Note the color needed at the time of ordering • All heights listed are within ¾" variants. Casters add 2-3" to the overall height.

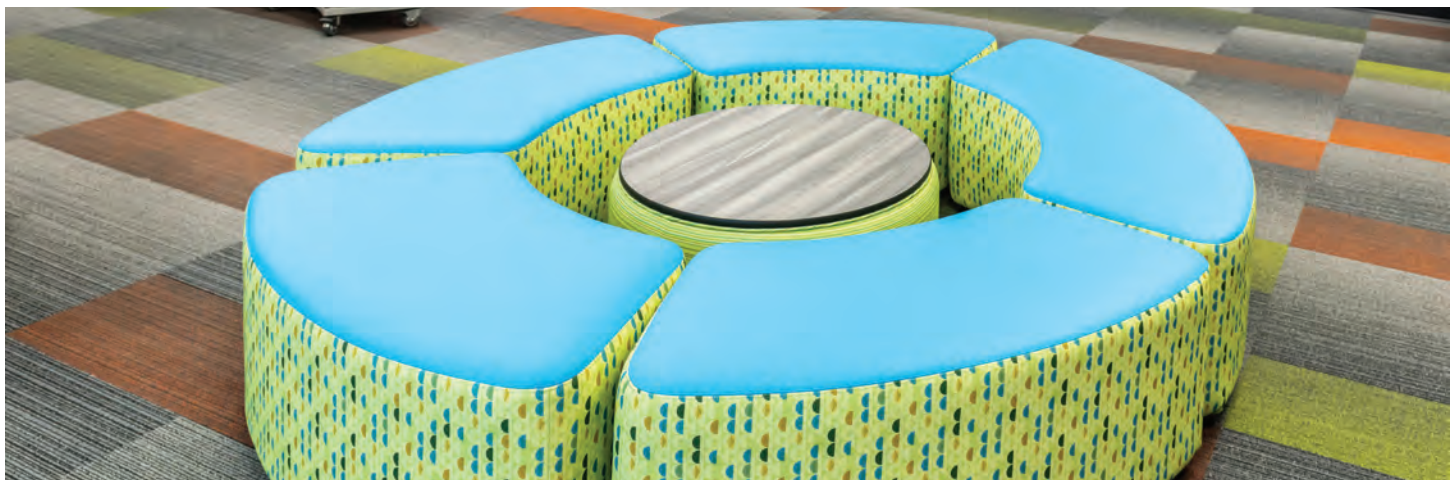



ST. FRANCIS XAVIER CATHOLIC SCHOOL - FORT MYERS, FL



Hercules Series – Table
Inspiration Series – Café Stools
Inspiration Series – School Chair
Junction – School Desk

S4 Stacking Series – School Desk



Stacks 4 high with locking casters and glides for quick rearranging or clean-up.

Concave and Convex sides offer various configurations for collaborative work study.

Extra large work surface allows 2 students to share one desk or combine 2 (no gap!) facing each other both ways.

Fully unitized frame guarantees years of strong usage. 7 standard HPL colors; custom colors available.

S4 Stacking STYLES



Fix. Ht.
4429 - S4 Student Desk



Adj. Ht.
4400A - S4 Student Desk

COLLABORATIVE - STUDENT DESK
S4 Stacking Series – School Desk



4429 - S4 Student Desk

TOP

Work Surface: 520 Sq. Inches

Desktop: Fiberboard 5/8" Thick High Pressure Laminate
 29"W x 20"D

FRAME

Utilized Frame: 1 1/2" Steel Round 17 Gauge Legs With 17 Gauge Upper Frame.

Bumpers: The desk's frame features 6 protective bumpers to avoid any scratches for safe stacking.

Legs: Wheelbarrow Style Legs w/ Ht. Adj. Nylon Glide

Adj. Ht. Desk

Insert Legs: 1 1/4" Insert Leg Tube

Height Adjustable: 21-33" H

Casters: 2" Locking Casters

HIGH PRESSURE LAMINATE EDGE FINISH

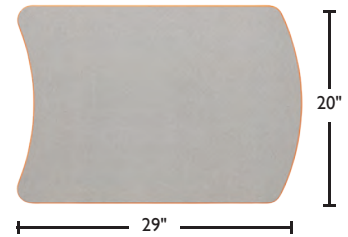

4429 - S4 Student Desk Stacked



4429 - Concave & Convex Sides



Locking Casters



Fully Unitized Frame

Synco Series – School Desk



Organic trapezium shape; handsome alone or engaging as pods

Rearranges with ease; adjustable heights, swivel casters

Groupings of four or five capitalize floor space, minimal footprint

Expansive knee room, all usable table-top space

Synco STYLES



5400 - Synco Desk Back
(Shown in Black Edge)



5400 - Synco Desk Front
(Shown in New Laminate Enrich and Light Grey Edge)

COLLABORATIVE - STUDENT DESK
Synco Series – School Desk



5400 - Synco Desk
 (Shown in Laminate Graphite Nebula and
 Light Gray Edge with Optional Casters)

TOP

Work Surface: Dimensions are 33.5" wide by 22" deep. 638 Sq. inches total.

Desktop: 1 1/8" thick fiberboard high pressure laminate surface.

FRAME

Upper Legs: Powder-coated 1.5" diameter: 16 gauge.

Insert Legs: Powder-coated 1.35" diameter: 16 gauge with two self-locking screws.

Height Adjustable: Adjusts 26-33" with glides. Legs adjust in 1" increments.

Wheelbarrow Option: Available.

Casters/Glides: Ht. Adj. glides (standard) or casters (optional)

HIGH PRESSURE LAMINATE EDGE FINISH



Ample Work Surface



Heavy Duty Support Plate



Pod of 4
 29 sq. ft of
 classroom space



Pod of 5
 36 sq. ft of
 classroom space



Adjustable Legs Compatible with
 Casters or Glides

Height Adjustable Glide

Optional Items: Bookboxes, Casters, Grommets, Hooks and Power.

Size & Order Info
 See pages 68-69

Colors, Guides,
 & Accessories
 See pages 152-157

Junction – School Desk



Book basket accessible in any arrangement; Ht. Adj. from K-12; individual use and pods of 3 or 4; many color options.

Total usable work area, both collaboratively or alone; intuitive to pod in configurations of 3 or 4.

T-molded edges, structured to withstand years of reconfiguring, choice of casters or glides.

Precisely designed as the ultimate pod desk - maximizes work surface, minimizes floor space.

Junction STYLES



5300 - Right Handed Junction Desk



5300LH - Left Handed Junction Desk

Junction – School Desk



5300 - Junction Desk

(Shown in Laminate Driftwood & Lime Green Educational Edge color with optional Casters & Mesh Bookbox)

TOP

Work Surface: 702 Sq. Inches

Desktop: 1 1/8" Thick High Pressure Laminate

FRAME

Upper Legs: Powder-Coated 2 1/4" Round 18-Gauge Steel

Insert Legs: Chrome-Plated 2" Round 16-Gauge Steel

Height Adjustable: Legs Adjust In 1" Increments

Casters/Glides: Compatible with Ht. Adj. Glides (Standard) or Casters (Optional)

HIGH PRESSURE LAMINATE EDGE FINISH



Pod of 3
23.7 sq. ft of classroom space



Pod of 4
34.4 sq. ft of classroom space

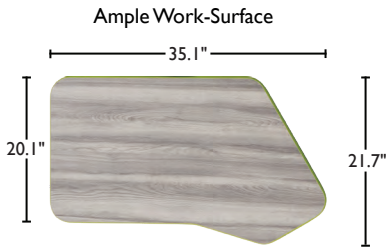

5300 - Pod of 3 & 4 Desks
(Shown with optional Casters & Mesh Bookbox)



Adjustable Legs
Compatible with
Casters or Glides



Heavy Duty
Support Plate

Optional Items: Hard and Soft Casters, Mesh Bookbox, Backpack Hook.

Size & Order Info
See pages 68-69

Colors, Guides,
& Accessories
See pages 152-157

Synergy – School Desk



The ultimate in collaborative seating. Individual desks or pods of 3, 4, 5 or 6.

Adjustable heights accommodate K-12. Sturdy, smooth surface cleans in a cinch.

Choice of casters or glides. Reinforcing supports add greater durability.

Artistic profile stands gracefully alone; fits together to form stylish shapes for student collaboration.

Synergy STYLES



Standard Ht.
5200 - Synergy Desk



Standing Ht.
5200SH - Synergy Desk

Synergy – School Desk



5200 - Pod of 6 Desks

(Shown in Standard White Board and custom laminates Wilsonart Ocean #D502, Formica Amarena #6907, Spectrum Blue #851, & Mouse #928 with optional Casters)

TOP

Work Surface: 681 Sq. Inches

Desktop: 1 1/8" Thick High Pressure Laminate

FRAME

Desk Supports: Powder Coated 3/4" Square 18 Gauge Steel Tubing

Upper Legs*: Powder-Coated 2 1/8" Round 18-Gauge Steel

Insert Legs: Chrome-Plated 2" Round 16-Gauge Steel with Two Self-Locking Screws

Standing Height Legs Only: Available in Black or Tungsten Color

Height Adjustable: Legs Adjust In 1" Increments

Casters/Glides: Compatible with Ht. Adj. Glides (Standard) or Casters (Optional)

HIGH PRESSURE LAMINATE EDGE FINISH



T-Mold
Standard



X-Strong
Optional



PVC 3mm
Optional

Space Saver

Synergy's multi-shaped options maximize collaborative workspace, while minimizing occupied classroom space.



Pod of 3
31 sq. ft of classroom space



Pod of 4
35 sq. ft of classroom space



Pod of 5
40 sq. ft of classroom space



Pod of 6
44 sq. ft of classroom space

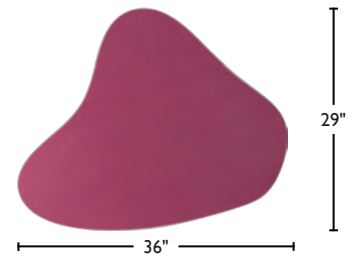

Need help configuring in groups?
Request a complimentary puzzle set.



Adjustable Legs
Compatible with
Casters or Glides



Heavy Duty
Support Plate

Optional Items: Hard and Soft Casters, Mesh Bookbox, Backpack Hook.

Size & Order Info
See pages 68-69

Colors, Guides,
& Accessories
See pages 152-157

Innovation Series – School Desk



The modern design offers ample legroom, perfect for students of any size.

Triangular desktop provides adaptability for multiple configurations.

Over 350 square inches of desktop space, plus two pencil grooves.

Unitized steel frame provides stability in any formation.

Innovation STYLES



Standard Ht.
2000 - Innovation Desk



Standing Ht.
2000SH - Innovation Desk

COLLABORATIVE - STUDENT DESK
Innovation Series – School Desk



TOP

Work Surface: 350 Sq. Inches

Desktop: 5/8" Thick High Pressure Laminate or Hard Plastic

Hard-Plastic Desktop Colors: Not Available in Light Gray and Beige.

FRAME

Utilized Frame: Triangular Powder-Coated Steel 3/4" Square Tube, 18-Gauge

Upper Legs: Powder-Coated 1 1/8" Round 18-Gauge Steel
 Available in Black or Tungsten Gray only

Insert Legs: Chrome-Plated 1 1/4" Round 16-Gauge Steel with Two Self-Locking Screws

Brace (Standing Height Legs Only): 3/4" Round 18-Gauge Steel Adjusts From 10-12"

Height Adjustable: Legs Adjust In 1" Increments

Glides: Poly Propylene Height Adjustable Glides

HIGH PRESSURE LAMINATE EDGE FINISH



2000 - Innovation Desks Pod

(Shown in custom laminate Wilsonart Flamingo #D497, Island #D498 & Ocean #D502)



Right-Handed Position



Forward Facing Position



Left-Handed Position

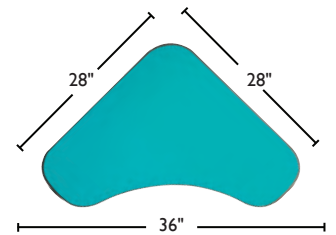

Matching Options



2000 - Innovation Desk
 (Shown with optional Backpack Hook and Mesh Bookbox.)



Unitized Frame



Power Post
 See pages 146-147

Optional Items: Backpack Hook, Glide Inserts (Nylon, Felt, Steel or Rubber), Glide Insert Replacements, Mesh Bookbox, Wire Bookrack, and Power Post.

Shown In: Wilsonart Flamingo #D497, Island #D498 & Ocean #D502

Size & Order Info
 See pages 68-69

Colors, Guides, & Accessories
 See pages 152-157

HARD PLASTIC
 See page 154

Academia
 FURNITURE INDUSTRIES
 www.academiafurniture.com

Petal Series – School Desk



Collaborative learning paired with ample personal space.

Over 500 square inches of desktop space—plenty of room for books and papers.

These versatile desks can be easily grouped together for collaborative learning.

Our Hercules legs combined with our new unitized frame form Olympic strength to provide years of use.

Petal STYLES



Toddler Ht.
1900S - Petal Desk



Standard Ht.
1900 - Petal Desk



Standing Ht.
1900SH - Petal Desk



1900 - Petal Top



1950 - Junior Petal Top



TOP

Petal Work Surface: 508 Sq. Inches
Junior Petal Work Surface: 513 Sq. Inches
Desktop: 1 1/8" Thick High Pressure Laminate
 Hard-Plastic Desktop Colors: Not Available in Beige.

FRAME

Fully Unitized Frame: Powder Coated 3/4" Square 18 Gauge Steel Tubing
Upper Legs: Powder-Coated 2 1/8" Round 18-Gauge Steel
Insert Legs: Chrome-Plated 2" Round 16-Gauge Steel with 2 Self-Locking Screws
Standing Height Legs Only: Available in Black or Tungsten Color.
Height Adjustable: Legs Adjust In 1" Increments
Casters/Glides: Compatible with Ht. Adj. Glides (Standard) or Casters (Optional)

HIGH PRESSURE LAMINATE EDGE FINISH



1950EE - Junior Petal Desk

(Shown with optional Casters and Mesh Bookbox and PVC 3mm Edge)

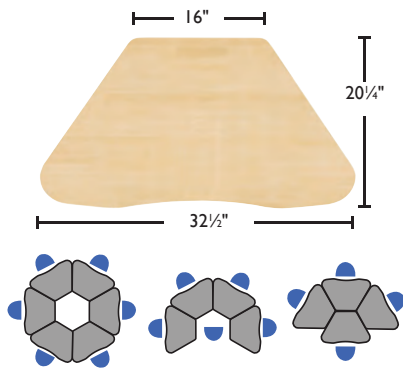

1900 - Petal Desk

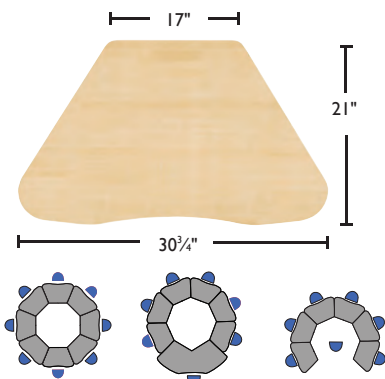

1950 - Junior Petal Desk

Matching Options



Fully Unitized Frame

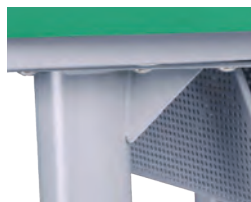

Heavy-duty support plate



New PVC 3mm Edge
 (Shown in Primary Green)

Optional Items: Backpack hook, Casters, Mesh Bookbox.

Shown In: Custom laminate Wilsonart Ocean #D502

Size & Order Info
 See pages 68-69

Colors, Guides, & Accessories
 See pages 152-157

HARD PLASTIC
 See page 154

Academia
 FURNITURE INDUSTRIES
 www.academiafurniture.com

Surge Series – School Desk



State-of-the-art adaptability maximizes attentiveness by letting students sit or stand with the same desk!

Safety lever gives wide range of sitting and standing options. Larger desktop suits teacher, too.

Use with any chair. Wide choice of finishes and colors. Choose glides or casters.

Fully welded steel frame is strong, yet sleek. Angled to insure absolute stability at all heights.

Surge STYLES



1626 - Surge Desk



1629 - Surge Desk

Surge Series – School Desk



1626 - Surge Desk
(Shown with optional Cup Holder and Mesh Bookbox)

TOP

Work Surface: 624 Sq. Inches

Desktop: 1 1/8" Thick High Pressure Laminate

FRAME

Surge Base: Rectangular steel tube structure. 26 x 20" heavy supportive gauge.

Height Adjustable: Pneumatic Lift Mechanism Adjust with 12" Range

Adjustable Ht. Option: 26-38" and 30-42"

Casters/Glides: Standard Casters; available with Ht. Adj. Glides

HIGH PRESSURE LAMINATE EDGE FINISH



T-Mold
Standard



X-Strong
Optional



PVC 3mm
Optional



Optional Cupholder



New & Improved
Pneumatic Lift Mechanism



Caster and Glide Compatible

Optional Items: Backpack Hook, Cup Holder, Mesh Bookbox, and Rubber Glides.

Shown In: 1626 in custom laminate Formica Cascara Teakwood #D497

Size & Order Info
See pages 68-69

Colors, Guides,
& Accessories
See pages 152-157

WOODSTONE HARD PLASTIC
See page 154

Academia
FURNITURE INDUSTRIES
www.academiafurniture.com

Illustration V2 Series – School Desk



The wide frame design gives students extra leg room and the legs are height-adjustable for use in any grade.

The soft interlocking leg supports the dual legs on either side making this desk the design of the future.

The 500+ square inch desktop is designed to give the students plenty of room for their books and their laptop.

The unitized frame design means that the desk is held together by steel tubing, not by the bookbox.

Illustration V2 STYLES



2700 - Adj. Ht. V2 Desk
(Shown with optional Casters and Mesh Bookbox)



2729 - Fix. Ht. V2 Desk

TRADITIONALLY MODERN - STUDENT DESK
Illustration V2 Series – School Desk



2729 - **Fix. Ht. V2 Desk**
 (Shown with custom Lime Green edge banding and optional Casters & Mesh Bookbox)

TOP

Work Surface: 520 Sq. Inches

Desktop: 5/8" Thick High Pressure Laminate, 26"W x 19 1/2"D

Pencil Groove: Available on Woodstone and Hard Plastic Desktops Only

FRAME

1" Steel Tube: 12-Gauge Steel, Welded At 90° Angle

Stretcher Bar: 1 1/4" Diameter, 18-Gauge Steel

Adj. Ht. Desk

Upper Legs: Two 1 1/2" Diameter Tubes 16-Gauge Steel

Insert Legs: Two 1 1/8" Diameter 16-Gauge Steel Chrome Legs with Two 18 x 1/2" Machine Screws

Height Adjustable: Legs Adjust In 1" Increments

Fix. Ht. Desk

Double Legs: Two 1 1/4" Diameter Tubes 16-Gauge Steel

Casters/Glides: Compatible with Ht. Adj. Glides (Standard) or Casters (Optional)

HIGH PRESSURE LAMINATE EDGE FINISH



Underside with Crossbar



Optional Back Pack Hook



Adjustable Height

Optional Items: Backpack Hook, Bookbox, Modesty Panel, and Rubber Glides.

Shown In: 2700 in custom laminate Formica White Malachite #9949

Size & Order Info
 See pages 68-69

Colors, Guides, & Accessories
 See pages 152-157

WOODSTONE HARD PLASTIC
 See page 154

Academia
 FURNITURE INDUSTRIES
 www.academiafurniture.com

T-Leg Series – School Desk



The wide frame design gives students extra leg room and the legs are height-adjustable for use in any grade.

Features a sturdy T-leg design which is secured by two self-locking screws and adjustable to heights from 22" to 32".

The 500+ square inch desktop is designed to give the students plenty of room for their books and their laptop.

The understructure is a unitized frame which makes this desk very sturdy.

T-Leg STYLES



1500WBB - T-Leg Desk with Bookbox



1500 - T-Leg Desk

T-Leg Series – School Desk



1500WBB - T-Leg Desk with Bookbox
(Shown in custom laminate Formica Ashen Ribbonwood #8839)

TOP

Work Surface: 520 Sq. Inches

Desktop: Fiberboard 5/8" Thick, 26" W × 19½" D

Bookbox (WBB): Chrome-plated steel bookbox for T-leg Desks 18" W × 16" D × 5" H

FRAME

Color: Light Gray or Black Frame Finish

Stretcher Bar: 6-Gauge Powder-Coated Rectangular Tube, 1½" W × 2½" D, Heavy Duty Bolts with 15-Gauge Angle Iron Support

Upper Legs: 16-Gauge Powder-Coated Rectangular Tubing 1½" W × 2½" D

Insert Legs: 16-Gauge Chrome-Plated Rectangular Tubing 1" W × 2" D with Three Self-Locking Screws

Height Adjustable: Legs Adjust In 1" Increments. With bookbox, the legs adjust from 22-25". Without a bookbox, they can adjust from 22-32".

Glides: Screw-In Style with Nylon Base. Micro-Adjustable

HIGH PRESSURE LAMINATE EDGE FINISH



T-Mold
Standard

X-Strong
Optional

PVC 3mm
Optional

Matching Options



T-Leg Tables
See page 124-125



Cross Bar

Adjustable Height



Bookbox Pencil
Groove

Micro-Adjustable Glide

Optional Items: Casters, Mesh Bookbox, and Rubber Glides.

Size & Order Info
See pages 68-69

Colors, Guides,
& Accessories
See pages 152-157

WOODSTONE HARD PLASTIC
See page 154

Academia
FURNITURE INDUSTRIES
www.academiafurniture.com

Standard Series – School Desk with Plastic Bookbox



With its adjustable height and choice of desktops, this desk is sure to enable every student to work comfortably.

This tried-and-true design now features two self-locking screws on each adjustable leg.

A plastic bookbox is as strong and long-lasting as steel yet it is quieter, lighter, rust proof and doesn't have sharp edges.

A unitized frame design for strength; held together by steel tubing and braces; optional U-brace.

Standard STYLES



Adj. Ht.
1100UEE2 - Standard Desk
with U-Brace



Fix. Ht.
1150EE2 - Standard Desk

Standard Series – School Desk with Plastic Bookbox



Adj. Ht.
 I100UEE2 - Standard Desk with U-Brace
 (Shown in custom laminate Formica Ashen Ribbonwood #8839)

TOP

Work Surface: 430 Sq. Inches

Desktop: 5/8" thick particleboard core, 24" x 18"

Bookbox: Heavy-Duty Propylene with Front Lip
 21"W x 17"D x 4 1/2"H. Color Bookbox Available

FRAME

U-Brace (U): 3/4" 18-Gauge Steel Welded To All Four Legs For Extra Support

Adj. Ht. Desk

Upper Legs: Chrome-Plated 1 1/8" Round 18-Gauge Steel

Insert Legs: 1" 18-Gauge with Two Self-Locking Screws

Height Adjustable: Legs Adjust In 1" Increments

Fix. Ht. Desk

Legs: Chrome-Plated 1 1/8" Round 18-Gauge Steel

Glides: One Height Adjustable, all four are self-leveling with Nickel Plated Casing Nylon Inserts.

HIGH PRESSURE LAMINATE EDGE FINISH



T-Mold
 Standard



X-Strong
 Optional



PVC 3mm
 Optional



Unitized Frame



U-Brace
 Welds

2 Screw
 Adjustable Leg

Optional Items: Glide Caps (Felt, Rubber and Steel).

Size & Order Info
 See pages 68-69

Colors, Guides,
 & Accessories
 See pages 152-157

WOODSTONE HARD PLASTIC
 See page 154

Academia
 FURNITURE INDUSTRIES
 www.academiafurniture.com

Standard Series – School Desk with Metal Bookbox



With its adjustable height and choice of desktops, this desk is sure to enable every student to work comfortably.

This tried-and-true design now features two self-locking screws on each adjustable leg.

The steel bookbox with built-in pencil tray has ample room for a student's books.

Unitized frame design, held together by steel tubing and braces, not by the bookbox.

Standard STYLES



Adj. Ht.
1200U - Standard Desk with U-Brace



Fix. Ht.
1250 - Standard Desk

Standard Series – School Desk with Metal Bookbox



Fix. Ht.
1250 - **Standard Desk**
(Shown in custom laminate Wilsonart Ocean #D502)

TOP

Work Surface: 430 Sq. Inches

Desktop: 5/8" thick particleboard core, 24" x 18"

Standard Bookbox: Open Front Powder-Coated 20-Gauge Steel 21"W x 17"D x 4 1/2"H

FRAME

U-Brace (U): 3/4" 18-Gauge Steel Welded To All Four Legs For Extra Support

Adj. Ht. Desk

Upper Legs: Chrome-Plated 1 1/8" Round 18-Gauge Steel

Insert Legs: 1" 18-Gauge with Two Self-Locking Screws

Height Adjustable: Legs Adjust In 1" Increments

Fix. Ht. Desk

Legs: Chrome-Plated 1 1/8" Round 18-Gauge Steel

Glides: One Height Adjustable, all four are self-leveling with Nickel Plated Casing Nylon Inserts

HIGH PRESSURE LAMINATE EDGE FINISH



Screws on Adjustable Leg

Unitized Frame



Pencil Groove

Riveted Bookbox

Optional Items: Glide Caps (Felt, Rubber and Steel).

Standard Series – Open View/Writing/Wheelchair School Desk



With its adjustable height and choice of desktops, these desks are sure to enable every student to work comfortably.

This tried-and-true design now features two self-locking screws on each adjustable leg.

The open-view storage area ensures that only necessary supplies are inside.

Unitized frame design, held together by steel tubing and braces; not by the bookbox.

Standard STYLES



1300U - Open View Standard Desk with Bookbasket & U-Brace



1400U - Adj. Writing Desk with U-Brace



1800UHP - ADA Standard Desk with U-Brace

Standard Series – Open View/Writing/Wheelchair School Desk



1400U - Adj. Writing Desk with U-Brace
(Shown in custom laminate Formica Matrix Blue #8795)

TOP

Work Surface: 430 Sq. Inches

ADA Work Surface: 520 Sq. Inch

Desktop: 5/8" thick particleboard core, 24" x 18"
Woodstones Desktops only available on the
1300 & 1400 series.

Bookbasket: 8-Gauge Steel 19"W x 14"D x 5"H

FRAME

U-Brace (U): 3/4" 18-Gauge Steel Welded To All Four
Legs For Extra Support

Adj. Ht. Desk

Upper Legs: Chrome-Plated 1 1/2" Round 18-Gauge
Steel

Insert Legs: 1" 18-Gauge with Two Self-Locking
Screws

Height Adjustable: Legs Adjust In 1" Increments

Fix. Ht. Desk

Legs: Chrome-Plated 1 1/2" Round 18-Gauge Steel

ADA Option Available: Wider Frame And A Higher
Top To Accommodate A Wheelchair & U-Brace is
Standard For Added Stability.

ADA 1800UHP - Only available in Beige, Gray Nebula,
Light Gray and Wild Cherry.

Glides: One Height Adjustable, all four are self-leveling
with Nickel Plated Casing Nylon Inserts

HIGH PRESSURE LAMINATE EDGE FINISH



Adjustable-Height Legs



Bookbasket Construction & Underside of Desk



Full-Contact Welds

Optional Items: Glide Caps (Felt, Rubber and Steel).

Size & Order Info
See pages 68-69

Colors, Guides,
& Accessories
See pages 152-157



Double Desks



Adjustable-height legs for student comfort, bookboxes can face either direction for any classroom layout.

18-gauge bookboxes are roomy enough to hold everything a student needs; strong and sturdy.

Get twice the learning done on the double desk. Students can work together or independently.

The unitized frame is self-supporting, meaning that the table is held together by heavy-gauge steel, not by the top.

Double Desks STYLES



1550 - T-Leg Double Desk



1650 - Activity-Leg Double Desk



2759 - Fix. Ht Illustration V2 Double Desk



2750 - Adj. Ht Illustration V2 Double Desk

Double Desks



2759 - **Fix. Ht Illustration V2 Double Desk**
 (Shown in custom laminate Formica Silver Oak Herringbone #9311)

TOP

Work Surface: 1,152" Sq. Inches

Desktop: 1½" Thick High-Pressure Laminate

FRAME

T-Leg Double Desk

Stretcher Bar: 16-Gauge Powder-Coated Rectangular Tube Welded 1¼"W × 2½"D with 15-Gauge Angle Iron Support

Upper Legs: 16-Gauge Powder-Coated Rectangular Tubing 1½"W × 2½"D

Insert Legs: 16-Gauge Chrome-Plated Rectangular Tubing 1"W × 2"D with Three Self-Locking Screws

Glides: Self-Adjusting Nickel-Plated Casing with Nylon Inserts

Activity-Leg Double Desk

Upper Legs: 1½" Outer-Diameter Powder-Coated Tubular Steel

Insert Legs: 1" Outer-Diameter 16-Gauge Chrome-Plated Tubular Steel with Self-Locking Screws

Height Adjustable: Legs Adjust In 1" Increments

Glides: Self-Adjusting Nickel-Plated Casing with Nylon Inserts

Illustration V2 Double Desk

1" Steel Tube: 12-Gauge Steel, Welded At 90° Angle

Stretcher Bar: 1¼" Diameter, 18-Gauge

Fix. Ht Desk Frame: Two 1¼" Diameter Tubes 16-Gauge Steel

Adj. Ht Desk Frame: Two 1½" Diameter, 16-Gauge Steel Chrome Legs

Height Adjustable: 27½"-31½"

Casters/Glides: Compatible with Ht. Adj. Glides (Standard) or Casters (Optional)

HIGH PRESSURE LAMINATE EDGE FINISH



Thick Desktop

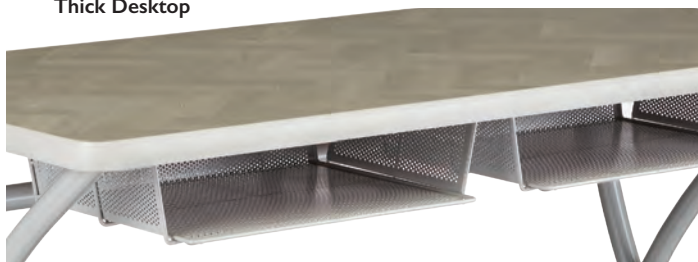

Spacious Bookboxes

Matching Options



Illustration V2 Desk
 See page 56-57

Optional Items: Backpack Hook, Casters, and Glides.

Size & Order Info
 See pages 68-69

Colors, Guides,
 & Accessories
 See pages 152-157

COLLABORATIVE - STUDENT DESK



S4 Stacking Series – School Desk

Desk Ht."	W × D"	Model
High Pressure Laminate		
29¼"	29 × 20"	4429
21-33	29 × 20	4400A
21-33	29 × 20	4400AEE



Junction – School Desk

Standard	Toddler	Standing Ht.
(23-32" H)	(17-22" H)	(26-42" H)
Right Hand (35.1 W × 21.7" D)		
5300	5300S	5300SH
5300EE	5300EES	—
Left Hand (35.1 W × 21.7" D)		
5300-LH	5300S-LH	5300SH-LH
5300EE-LH	5300EES-LH	—

Optional Items: Hard and Soft Casters, Mesh Bookbox, Backpack Hook.



Synergy – School Desk

Standard	Toddler	Standing Ht.
(23-32" H)	(17-22" H)	(26-42" H)
Synergy (29 W × 36" D)		
5200	5200S	5200SH
5200EE	5200EES	—

Optional Items: Hard and Soft Casters, Mesh Bookbox, Backpack Hook.



Petal Series – School Desk

Standard	Toddler	Standing Ht.
(23-32"H)	(17-22"H)	(26-42"H)
Petal (32½ W × 20¼" D)		
1900	1900S	1900SH
1900EE	1900EES	—
1900HP	1900HPS	1900HPSH
1900HPEE	1900HPEES	—
Junior Petal (30¾ W × 21" D)		
1950	1950S	1950SH
1950EE	1950EES	—
1950HP	1950HPS	1950HPSH
1950HPEE	1950HPEES	—

Optional Items: Backpack hook, Casters, Mesh Bookbox.

Hard-Plastic Desktop Colors: Not Available in Beige.



Synco Series – School Desk

Standard Ht.	Model
26-33"	5400

Optional Items: Bookboxes, Casters, Grommets, Hooks and Power.



Innovation Series – School Desk

Standard	Standing Ht.
(23-33" H)	(31-43" H)
Innovation Desk (36 W × 28" D)	
2000	2000SH
2000HP	2000HPSH

Optional Items: Backpack Hook, Glide Inserts (Nylon, Felt, Steel or Rubber), Glide Insert Replacements, Mesh Bookbox, Wire Bookrack, and Power Post.

Hard-Plastic Desktop Colors: Not Available in Light Gray and Beige.

TRADITIONALLY MODERN - STUDENT DESK



Surge Series – School Desk

W × D"	Standard Ht.	
	Adj. 26½-38½" H	Adj. 29-42" H
High Pressure Laminate		
26½ × 24"	1626	1629
Hard-Plastic		
26¾ × 19½"	1626HP	1629HP
WoodStone		
26¾ × 19½"	1626WS	1629WS

Optional Items: Backpack Hook, Cup Holder, Mesh Bookbox, and Rubber Glides.



Illustration V2 Series – School Desk

W × D"	Standard Ht.		
	Adj. 26-30" H	Fix. 26" H	Fix. 29" H
High Pressure Laminate			
27¾ × 19½"	2700	2726	2729
27¾ × 19½"	2700WBB	2726WBB	2729WBB
Hard-Plastic			
26¾ × 19½"	2700HP	2726HP	2729HP
26¾ × 19½"	2700HPWBB	2726HPWBB	2729HPWBB
WoodStone			
26¾ × 19½"	2700WS	2726WS	2729WS
26¾ × 19½"	2700WSWBB	2726WSWBB	2729WSWBB

Optional Items: Backpack Hook, Bookbox, Modesty Panel, and Rubber Glides.

Edge Finish & Color Options

Junction, Synergy & Petal Series

Standard: Hydraulically inserted T-Mold edge banding in Black or Gray.

Optional Educational Edge (EE): Color coordinated edge banding and legs are available for Standard and Toddler Height. Standing Height legs are only available in Black or Gray.

Optional X-Strong Finish and PVC 3mm Finish: Are available in all standard and Educational Edge colors.

S4 Series, Synco, Innovation Series, Surge Series & Illustration V2 Series

Standard: Hydraulically inserted T-Mold edge banding in Black or Gray.

Optional: Colored T-Mold edge.

Optional X-Strong Finish and PVC 3mm Finish: Are available in all standard and colored edge options.

See page 154 for more details.

Note the color needed at the time of ordering • All heights listed are within ¾" variants & Casters add 2-3" to the overall height



T-Leg Series – School Desk

W × D"	Standard Ht.
	22½-32½" H

High Pressure Laminate	
27¾ × 19½"	1500
27¾ × 19½"	1500WBB
Hard-Plastic	
26¾ × 19½"	1500HP
26¾ × 19½"	1500HPWBB
WoodStone	
26¾ × 19½"	1500WS
26¾ × 19½"	1500WSWBB

Optional Items: Casters, Mesh Bookbox, and Rubber Glides.

T-Leg Desks Color: Light Gray or Black Frame Finish



Standard Series – School Desk w/ Plastic Bookbox

W × D"	Adj. 24-31" H	Fix. 29½" H
--------	---------------	-------------

High Pressure Laminate		
24 × 18½"	1100	1150
24 × 18½"	1100EE	1150EE
24 × 18½"	1100EE2	1150EE2
24 × 18½"	1100U	1150U
24 × 18½"	1100UEE	1150UEE
24 × 18½"	1100UEE2	1150UEE2

Hard-Plastic		
24 × 18½"	1100HP	1150HP
24 × 18½"	1100HPPEE2	1150HPPEE2
24 × 18½"	1100UHP	1150UHP
24 × 18½"	1100UHPEE2	1150UHPEE2

WoodStone		
24 × 18½"	1100WS	1150WS
24 × 18½"	1100WSEE2	1150WSEE2
24 × 18½"	1100UWS	1150UWS
24 × 18½"	1100UWSEE2	1150UWSEE2

Optional Items: Glide Caps (Felt, Rubber and Steel).



Standard Series – School Desk w/ Metal Bookbox

W × D"	Adj. 24-31"H	Fix. 29½" H
--------	--------------	-------------

High Pressure Laminate		
24 × 18½"	1200	1250
24 × 18½"	1200EE	1250EE
24 × 18½"	1200U	1250U
24 × 18½"	1200UEE	1250UEE

Hard-Plastic		
24 × 18½"	1200HP	1250HP
24 × 18½"	1200UHP	1250UHP

WoodStone		
24 × 18½"	1200WS	1250WS
24 × 18½"	1200UWS	1250UWS

Optional Items: Glide Caps (Felt, Rubber and Steel).

Standard Series – Open View/Writing School Desk



W × D"	Adj.	Fix.
	Adj. (24-31" H)	(29½" H)

High Pressure Laminate w/ bookbasket		
24 × 18½"	1300	1350
24 × 18½"	1300U	1350U

High Pressure Laminate w/o bookbasket		
24 × 18½"	1400U	1450U

Hard-Plastic w/ bookbasket		
24 × 18½"	1300HP	1350HP
24 × 18½"	1300UHP	1350UHP

Hard-Plastic w/o bookbasket		
24 × 18½"	1400UHP	1450UHP

WoodStone w/ bookbasket		
24 × 18½"	1300WS	1350WS
24 × 18½"	1300UWS	1350UWS

WoodStone w/o bookbasket		
24 × 18½"	1400UWS	1450UWS



Standard Series – Wheelchair School Desk

W × D"	ADA**
	Adj. (26-34" H)

High Pressure Laminate	
36 × 20"	1800U

Hard-Plastic	
36 × 20"	1800UHP



Optional Items: Glide Caps (Felt, Rubber and Steel).

**ADA 1800UHP - Only available in Beige, Gray Nebula, Light Gray and Wild Cherry.



Double Desks

Table Ht."	W × D"	Model
------------	--------	-------

T-Leg Series Double Desk		
22½-32½"	48 × 24"	1550

Activity Series Double Desk		
23-32"	48 × 24"	1650

Illustration V2 Series Double Desk		
27½-31½"	48 × 24"	2750
29"	48 × 24"	2759

Optional Items: Backpack Hook, Casters, and Glides. (Casters for T-Leg & Illustration V2 Series Double Desk only).

T-Leg Double Desk are not available with a Light Gray or Black Frame Finish.

Bookboxes are standard on all Double Desk. See all standard bookboxes on page 157

Edge Finish & Color Options

T-Leg Series, Standard Series & Double Desks

Standard: Hydraulically inserted T-Mold edge banding in Black or Gray.

Optional: Colored T-Mold edge.

Optional X-Strong Finish and PVC 3mm Finish: Are available in all standard and colored edge options.

Standard Series School Desk w/ Plastic Bookbox

Standard: Hydraulically inserted T-Mold edge banding in Black or Gray with black bookbox.

Optional: Colored T-Mold edge.

Optional X-Strong Finish and PVC 3mm Finish: Are available in all standard and colored edge options.

Optional Colored Bookbox (EE2): Is available for HPL, Hard-Plastic and Woodstone.

See page 154 for more details.

Note the color needed at the time of ordering • All heights listed are within ¾" variants & Casters add 2-3" to the overall height

Unity Study – School Combo Desk



Features locking casters, roomy and accessible book storage, and a unique design for collaboration.

Mobile; can easily work together. Slide back to work solo after group project is done.

Sitting on the chair locks casters into place securely. Efficiently re-group students as needed with one-handed ease.

Long-lasting hard plastic or laminate surface. Secure; won't slide or tip.

Unity Study STYLES



2958C - 18" Unity Study Combo Desk w/ Back Casters

Unity Study – School Combo Desk



2958C - 18" Unity Study Combo Desk

(Shown in custom laminate Formica Weathered Beamwood #6410)

SEAT

Shell: One-Piece, Color-Impregnated Polypropylene Molded Plastic with Built-In Carry Handle

Back: Lumbar Support

DESK

Work Surface: 507 Sq. Inches

Desktop: 5/8" Thick, 32 1/2"W × 20 1/4"D

FRAME

Bookbasket*: Chrome-Plated 1/4" Rod Steel
14 1/2"W × 12"D × 8"H

Seat & Desktop Supports: 1 1/8" Round 14-Gauge Steel

Front Legs: Chrome-Plated 1 1/8" Round 16-Gauge Steel

Front Glides: Self-Adjusting Nylon

Back Legs: Chrome-Plated, 1 1/8" Round 18-Gauge Steel

Back Casters: Double Hooded 2" Self-Braking Casters

*Bookbasket on combo is standard, but can be requested without one at the time of ordering. Bookbasket must be installed by manufacturer.

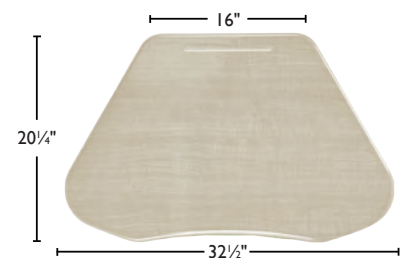

Pod of Four

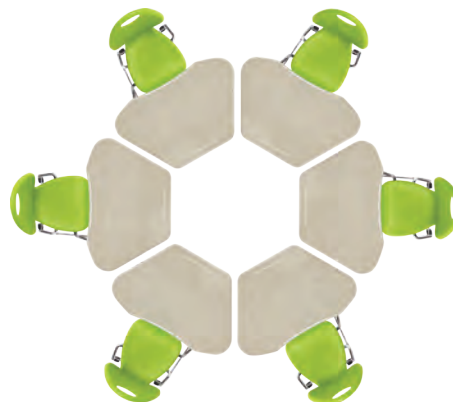

Pod of Six



Back with Ribs

Optional Items: Glide Caps (Felt, Rubber and Steel), and Hard & Soft Casters.

Size & Order Info
See pages 82-85

Colors, Guides,
& Accessories
See pages 152-157



See page 154

Academia
FURNITURE INDUSTRIES
www.academiafurniture.com

Inspiration Series – School Combo Desk



Inspirational shell design, arc-shaped WoodStone desktop, and curved U-brace.

The dual curves and flex action of the back provide exceptional back support.

Heavy-gauge, 1½" round tubing with standard U-brace, full contact welds.

120 Memory swivel seat allows for easy entry and exit.

Inspiration STYLES



2918WS - 18" Inspiration Combo Desk



2918WSSB - Sled Base Combo Desk

Inspiration Series – School Combo Desk



2918WS - 18" Inspiration Combo Desk

SEAT

Shell: Injection-Molded Polypropylene Plastic with Built-In Carry Handle

Back: Lumbar Support

DESK

Work Surface: 432 Sq. Inches

Desktop: Arc-Shaped Woodstone with Built-In Pencil Groove $\frac{3}{8}$ " Thick, 27"W × 19½"D

FRAME

Bookbasket*: Chrome-Plated $\frac{1}{4}$ " Rod Steel
14½"W × 12"D × 8"H

Standard

Seat & Desktop Supports: 1½" Round 14-Gauge Steel

Front Legs: Chrome-Plated 1½" Round 16-Gauge Steel

Back Legs: Chrome-Plated, 1½"- Round 18-Gauge Steel

Wraparound Brace: ¾" Round 18-Gauge Steel

Boots: Color-Impregnated Polypropylene Plastic

Glides: Self-Adjusting Nylon

Sled Base

Frame: 1½" 14-Gauge

Optional Glides: Rubber screw-in glides add on item

X-Plus (X): Larger shell and Frame for added weight capacity available.

*Bookbasket on combo is standard, but can be requested without one at the time of ordering. Bookbasket must be installed by manufacturer.



Curved Desktop and Support Brace



X-Plus Offers Additional 1" Clearance from Seat to Desktop



Full-Contact Welds



Optional Items: Glide Caps (Felt, Rubber and Steel) and Rubber screw-in glides for Sled Base combo.

Size & Order Info
See pages 82-85

Colors, Guides,
& Accessories
See pages 152-157

WOODSTONE
See page 154

Academia
FURNITURE INDUSTRIES
www.academiafurniture.com

Classic Series – School Combo Desk



Classic waterfall edge seat with curved, vented back and unobstructed legroom add up to classic comfort.

In any classroom old or new, our curved seat and vented back offer a timeless design. 400+ square inch desktop.

The built-in bookbasket and pencil groove will keep students happy and the classroom neat.

Side-by-side tubular steel back supports, 14-gauge underseat brackets and angled side-brace for stability.

Classic STYLES



2214 - 14" Classic Combo Desk
(Shown with Driftwood top and custom Aqua edge banding)



2618 - Sled Base Combo Desk

Classic Series – School Combo Desk



2218 - 18" Classic Combo Desk
(Shown with Driftwood top and custom Purple edge banding)

SEAT

Shell: Injection-Molded Polypropylene Plastic with Waterfall Front and Vented Back

Back Support: 16-gauge Steel Built-In Supports

DESK

Work Surface: 430 Sq. Inches

Desktop: 5/8" Thick with PVC Edge Banding 24" × 18 1/2"

FRAME

Bookbasket*: Chrome-Plated 1/4" Rod Steel
14 1/2"W × 12"D × 8"H

Standard

Seat and Desktop Supports: 1 1/8" Round 14-Gauge Steel

Front Legs: Chrome-plated, 1 1/8" round 16-gauge steel

Back Legs: Chrome-Plated, 1 1/8" Round 18-Gauge Steel

Glides: Self-Adjusting Nylon

Sled Base

Frame: Chrome-Plated, 1 1/4" Round, 14-Gauge. Ease of entry from either side, perfect for carpeted areas, extra strong frame.

Optional Glides: Rubber screw-in glides add on item

*Bookbasket on combo is standard, but can be requested without one at the time of ordering. Bookbasket must be installed by manufacturer.



14-Gauge Underseat Steel



Steel Back Supports



Optional Items: Glide Caps (Felt, Rubber and Steel) and Rubber screw-in glides for Sled Base combo.

Size & Order Info
See pages 82-85

Colors, Guides,
& Accessories
See pages 152-157

WOODSTONE HARD PLASTIC
See page 154

Academia
FURNITURE INDUSTRIES
www.academiafurniture.com

Hard-Plastic Series – School Combo Desk



The contoured seat and posture-perfect back are mated to a choice of desktops to create a comfortable work center.

This time-tested design encourages teacher-student learning while keeping the classroom neat and tidy.

Our strongest seat and back plus our strongest frame makes this one of the strongest combos available.

The one-piece construction of this combo brings together our hard-plastic chair and desktop, in one easy-to-move unit.

Hard-Plastic STYLES



2518 - 18" Hard-Plastic Combo Desk



2628 - 18" Sled Base Combo Desk
(Shown in custom laminate Wilsonart Ocean #D502)

Hard-Plastic Series – School Combo Desk



2518 - 18" Hard-Plastic Combo Desk

SEAT

Back: $\frac{3}{8}$ " Thick Hard-Plastic 13 $\frac{1}{8}$ " W × 6 $\frac{3}{8}$ " L

Seat: $\frac{3}{8}$ " Thick

Back Support: $\frac{3}{4}$ " Round,
16", 18" & 19" - 14-Gauge Steel
14" Combos - 16-Gauge Steel

DESK

Work Surface: 430 Sq. Inches

Desktop: $\frac{3}{8}$ " Thick with PVC Edge Banding
24" × 18 $\frac{1}{2}$ "

FRAME

Bookbasket*: Chrome-Plated $\frac{1}{4}$ " Rod Steel
14 $\frac{1}{2}$ " W × 12" D × 8" H

Standard

Seat and Desktop Supports: Chrome-Plated 1 $\frac{1}{8}$ "
Round 14-Gauge Steel

Front Legs: Chrome-Plated 1 $\frac{1}{8}$ " Round 16-Gauge
Steel

Back Legs: Chrome-Plated, 1 $\frac{1}{8}$ " Round 18-Gauge

Glides: Self-Adjusting Nylon

Sled Base

Frame: Chrome-Plated, 1 $\frac{1}{4}$ " Round, 14-Gauge. Ease of
entry from either side, perfect for carpeted areas, extra
strong frame.

Optional Glides: Rubber screw-in glides add on item

*Bookbasket on combo is standard, but can be
requested without one at the time of ordering.
Bookbasket must be installed by manufacturer.



Bookbasket

Optional Sled Base Glide



Full-Contact Welds

Under Desktop Construction



18 $\frac{1}{2}$ "

24"

Optional Items: Glide Caps (Felt, Rubber and Steel) and Rubber screw-in glides for Sled Base combo.

Size & Order Info
See pages 82-85

Colors, Guides,
& Accessories
See pages 152-157



See page 154

Academia
FURNITURE INDUSTRIES
www.academiafurniture.com

Hard-Plastic Series – Braced School Combo Desk



Our hard-plastic seat and back are paired with a braced frame design to make the strongest combo desk available.

This time-tested design encourages teacher-student learning while keeping the classroom neat and tidy.

The combo design and integrated bookbasket keep both the students and their books in the right place.

The contoured seat and posture-perfect back are paired with a spacious rectangular desktop or tablet-arm.

Hard-Plastic STYLES



2538WS - Double Braced Combo Desk with Arc-Shaped WoodStone Desktop



2528HP - Single Braced Combo Desk with Rectangular Hard-Plastic Desktop



2528JHP - Single Braced Combo Desk with Jumbo Tablet-Arm Hard-Plastic Desktop

Hard-Plastic Series – Braced School Combo Desk



2538WS - Double Braced Combo Desk with Arc-Shaped WoodStone Desktop

SEAT

Back: 5/8" Thick Hard-Plastic 13 1/2" W × 6 3/4" L

Seat: 5/8" Thick

Back Support: 3/4" Round
16", 18" & 19" - 14-Gauge Steel
14" Combos - 16-Gauge Steel

DESK

Arc-Shaped Work Surface: 432 Sq. Inches.

Desktop: Woodstone Desktop with Built-In Pencil Groove 3/8" Thick, 27"W × 19 1/2"D

Rectangular Work Surface: 430 Sq. Inches

Desktop: 5/8" Thick with Pencil Groove, 24"W × 18 1/2"D.
Various Right & Left-Handed Options.
See pages 82-85 for details.

Jumbo Tablet-Arm Work Surface: 470 Sq. Inches

Desktop: 5/8" Thick with Pencil Groove, 24"W × 17 1/2"D.

FRAME

Bookbasket*: Chrome-Plated 1/4" Rod Steel
14 1/2"W × 12"D × 8"H

Seat and Desktop Supports: Chrome-Plated 1 1/8" Round, 14-Gauge Steel

Double Braced Frame (253): Includes 8 gauge wrap around tubing for added strength and support. Double Braced is available on Hard Plastic only.

Front Legs: Chrome-Plated 1 1/8" Round, 16-Gauge Steel

Back Legs: Chrome-Plated 1 1/8" Round, 18-Gauge Steel

Glides: Self-Adjusting Nylon

*Bookbasket on combo is standard, but can be requested without one at the time of ordering. Bookbasket must be installed by manufacturer.



Full-Contact Welds



Bookbasket

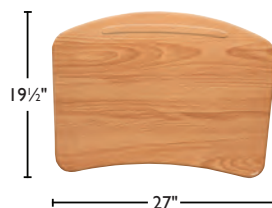

Arc-Shaped

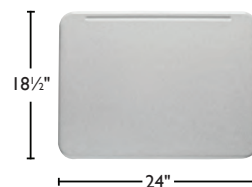

Rectangular

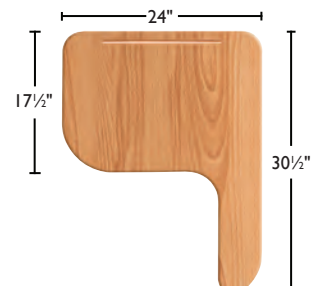

Jumbo Tablet-Arm

Optional Items: Glide Caps (Felt, Rubber and Steel).

Size & Order Info
See pages 82-85

Colors, Guides,
& Accessories
See pages 152-157



See page 154

Academia
FURNITURE INDUSTRIES
www.academiafurniture.com

Classic and Hard Plastic Series – School Tablet-Arm Combo



The contoured seat and posture-perfect back are mated to a choice of desktops to create a comfortable work center.

The angled inside edge of the desktop along with the tablet-arm area offer easy access and are extremely supportive.

Designed for testing and lighter-use areas. Perfect for quick turnover applications.

Made with 18-gauge steel legs and 14-gauge steel braces, these tablet-arm chairs are built to last.

Classic and Hard Plastic STYLES



3218HP - 18" Classic Tablet-Arm Combo Desk



3518HP - 18" Right Handed Hard Plastic Tablet-Arm Combo Desk

Classic and Hard Plastic Series – School Tablet-Arm Combo



3218HP - 18" Classic Tablet-Arm Combo Desk



3518HP - 18" Right Handed Hard Plastic Tablet-Arm Combo Desk

SEAT

Classic

Shell: Injection-Molded Polypropylene Plastic with Waterfall Front and Vented Back

Back Support: 16-gauge Steel Built-In Supports

Hard Plastic

Back: $\frac{5}{8}$ " Thick Hard-Plastic 13 $\frac{1}{8}$ " W × 6 $\frac{3}{8}$ " L

Seat: $\frac{5}{8}$ " Thick

Back Supports: $\frac{3}{4}$ " Round, 14-Gauge Chrome-Plated Steel

DESK

Desktop: $\frac{5}{8}$ " Thick, 19" W × 26"D with Self-Edge & Pencil Groove

FRAME

Bookbasket*: Chrome-Plated $\frac{1}{4}$ " Rod Steel. 14 $\frac{1}{2}$ " W × 12"D × 8"H

Classic

Seat & Desktop Frame: Chrome-Plated 1 $\frac{1}{8}$ " Round 16-Gauge Steel

Underseat Brackets: Two 14-Gauge Steel

Glides: Self-Adjusting Nylon

Hard Plastic

Desktop Supports: Chrome-Plated $\frac{7}{8}$ " Round, 14-Gauge Steel

Legs: 1" Round 16-Gauge Chrome-Plated Steel

Glides: Self-Adjusting Nickel-Plated Casing With Nylon Inserts

*Bookbasket on combo is standard, but can be requested without one at the time of ordering. Bookbasket must be installed by manufacturer.



Underseat Steel Structure



Bookbasket

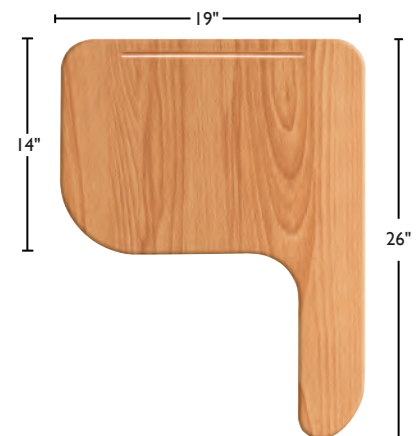

Optional Items: Glide Caps (Felt, Rubber and Steel).

Size & Order Info
See pages 82-85

Colors, Guides,
& Accessories
See pages 152-157

WOODSTONE HARD PLASTIC
See page 154

Academia
FURNITURE INDUSTRIES
www.academiafurniture.com



Unity Study – School Combo Desk

Seat Ht."	Seat W × D"	Overall W × H × D"	Model
High Pressure Laminate			
18"	17¾ × 16"	32½ × 29 × 38½"	2958
18"	17¾ × 16"	32½ × 29 × 38½"	2958C
Hard Plastic			
18"	17¾ × 16"	32½ × 29 × 38½"	2958HP
18"	17¾ × 16"	32½ × 29 × 38½"	2958CHP

Optional Items: Glide Caps (Felt, Rubber and Steel), and Hard & Soft Casters.

Back Casters can be replaced with glides.

Inspiration Series – School Combo Desk



Seat Ht."	Seat W × D"	Overall W × H × D"	Model
WoodStone			
14"	12¼ × 12"	27 × 24¾ × 34"	2914WS
16"	16 × 16"	27 × 31½ × 37"	2916WS
18"	17¾ × 16"	27 × 33½ × 37"	2918WS
18"	17¾ × 16"	27 × 33½ × 37"	2918XWS
19"	17¾ × 16"	27 × 34½ × 37"	2919WS
19"	17¾ × 16"	27 × 34½ × 37"	2919XWS



Seat Ht."	Seat W × D"	Overall W × H × D"	Model
Sled Base			
18"	17¾ × 16"	27 × 33½ × 38"	2918WSSB

X-Plus (X): Larger shell and Frame for added weight capacity available.

Optional Items: Glide Caps (Felt, Rubber and Steel) and Rubber screw-in glides for Sled Base combo.

About Bookbasket

Combo Bookbasket: Bookbasket on combo is standard, but can be requested without one at the time of ordering. Bookbasket must be installed by manufacturer.

Note the color needed at the time of ordering • All heights listed are within ¼" variants.

Classic Series – School Combo Desk



Seat Ht."	Seat W × D"	Overall W × H × D"	Right Hand	Left Hand
High Pressure Laminate				
14"	13 × 12"	24 × 27¾ × 34"	2214	2214LH
16	16¼ × 15	24 × 29½ × 33	2216	2216LH
18	16¼ × 15	24 × 31½ × 33	2218	2218LH
19	16¼ × 15	24 × 33 × 36	2219	2219LH
Hard-Plastic				
14"	13 × 12"	24 × 27¾ × 34"	2214HP	2214HP-LH
16	16¼ × 15	24 × 29½ × 33	2216HP	2216HP-LH
18	16¼ × 15	24 × 31½ × 33	2218HP	2218HP-LH
19	16¼ × 15	24 × 33 × 36	2219HP	2219HP-LH
WoodStone				
14"	13 × 12"	24 × 27¾ × 34"	2214WS	2214WS-LH
16	16¼ × 15	24 × 29½ × 33	2216WS	2216WS-LH
18	16¼ × 15	24 × 31½ × 33	2218WS	2218WS-LH
19	16¼ × 15	24 × 33 × 36	2219WS	2219WS-LH



Seat Ht."	Seat W × D"	Overall W × H × D"	Model
Sled Base			
18"	16¼ × 15"	27 × 33¼ × 38"	2618
18	16¼ × 15	27 × 33¼ × 38	2618HP
18	16¼ × 15	27 × 33¼ × 38	2618WS

Optional Items: Glide Caps (Felt, Rubber and Steel) and Rubber screw-in glides for Sled Base combo.

Hard-Plastic Series – School Combo Desk



Seat Ht."	Seat W × D"	Overall W × H × D"	Right Hand	Left Hand
High Pressure Laminate				
14"	13½ × 13"	24 × 27½ × 33"	2514	2514-LH
16	15¾ × 15	24 × 29½ × 34	2516	2516-LH
18	15¾ × 15	24 × 31¼ × 34	2518	2518-LH
19	15¾ × 15	24 × 32¾ × 36	2519	2519-LH
Hard Plastic				
14"	13½ × 13"	24 × 27½ × 33"	2514HP	2514HP-LH
16	15¾ × 15	24 × 29½ × 34	2516HP	2516HP-LH
18	15¾ × 15	24 × 31¼ × 34	2518HP	2518HP-LH
19	15¾ × 15	24 × 32¾ × 36	2519HP	2519HP-LH
WoodStone				
14"	13½ × 13"	24 × 27½ × 33"	2514WS	2514WS-LH
16	15¾ × 15	24 × 29½ × 34	2516WS	2516WS-LH
18	15¾ × 15	24 × 31¼ × 34	2518WS	2518WS-LH
19	15¾ × 15	24 × 32¾ × 36	2519WS	2519WS-LH



Seat Ht."	Seat W × D"	Overall W × H × D"	Model
Sled Base			
18"	15¾ × 15"	24 × 32 × 35"	2628
18	15¾ × 15	24 × 32 × 35	2628HP
18	15¾ × 15	24 × 32 × 35	2628WS

Optional Items: Glide Caps (Felt, Rubber and Steel) and Rubber screw-in glides for Sled Base combo.

Note the color needed at the time of ordering • All heights listed are within ¾" variants.

Colors, Guides,
& Accessories
See pages 152-157

Hard-Plastic Series – Braced School Combo Desk



Seat Ht."	Seat W × D"	Overall W × H × D"	Right Hand	Left Hand
High-Pressure Laminate				
14"	13½ × 13"	24 × 27½ × 33"	2524	2524-LH
16	15¼ × 15	24 × 29½ × 34	2526	2526-LH
18	15¼ × 15	24 × 31¼ × 34	2528	2528-LH
19	15¼ × 15	24 × 32¾ × 34	2529	2529-LH
Hard-Plastic				
14"	13½ × 13"	24 × 27½ × 33"	2524HP	2524HP-LH
16	15¼ × 15	24 × 29½ × 34	2526HP	2526HP-LH
18	15¼ × 15	24 × 31¼ × 34	2528HP	2528HP-LH
19	15¼ × 15	24 × 32¾ × 36	2529HP	2529HP-LH
WoodStone				
14"	13½ × 13"	24 × 27½ × 33"	2524WS	2524WS-LH
16	15¼ × 15	24 × 29½ × 34	2526WS	2526WS-LH
18	15¼ × 15	24 × 31¼ × 34	2528WS	2528WS-LH
19	15¼ × 15	24 × 32¾ × 36	2529WS	2529WS-LH



Seat Ht."	Seat W × D"	Overall W × H × D"	Right Hand
Hard-Plastic Tablet-Arm			
14"	13½ × 13"	24 × 27½ × 33"	2524JHP
16	15¼ × 15	24 × 29½ × 34	2526JHP
18	15¼ × 15	24 × 31¼ × 34	2528JHP
19	15¼ × 15	24 × 32¾ × 36	2529JHP
WoodStone Tablet-Arm			
14"	13½ × 13"	24 × 27½ × 33"	2524JWS
16	15¼ × 15	24 × 29½ × 34	2526JWS
18	15¼ × 15	24 × 31¼ × 34	2528JWS
19	15¼ × 15	24 × 32¾ × 36	2529JWS



Hard-Plastic Series – Double Braced School Combo Desk

Seat Ht."	Seat W × D"	Overall W × H × D"	Right Hand
WoodStone			
18	15¼ × 15	24 × 31¼ × 34	2538WS
Hard Plastic			
18	15¼ × 15	24 × 31¼ × 34	2538HP

Optional Items: Glide Caps (Felt, Rubber and Steel).

About Bookbasket

Combo Bookbasket: Bookbasket on combo is standard, but can be requested without one at the time of ordering. Bookbasket must be installed by manufacturer.

Note the color needed at the time of ordering • All heights listed are within ¼" variants.

Classic Series – School Tablet-Arm Combo

Seat Ht."	Seat W × D"	Overall W × H × D"	Right Hand
WoodStone			
16"	16¼ × 15"	21 × 29 × 31"	3216WS
18	16¼ × 15	21 × 31½ × 31	3218WS
19	16¼ × 15	21 × 31½ × 32	3219WS
Hard-Plastic			
16"	16¼ × 15"	21 × 29 × 31"	3216HP
18	16¼ × 15	21 × 31½ × 32	3218HP
19	16¼ × 15	21 × 31½ × 32	3219HP

Hard Plastic Series – School Tablet-Arm Combo

Seat Ht."	Seat W × D"	Overall W × H × D"	Right Hand
WoodStone			
15¾"	15¾ × 15"	20 × 28½ × 31"	3516WS
17¾	15¾ × 15	20 × 30½ × 31	3518WS
19	15¾ × 15	20 × 31½ × 31	3519WS
Hard-Plastic			
15¾"	15¾ × 15"	20 × 28½ × 31"	3516HP
17¾	15¾ × 15	20 × 30½ × 31	3518HP
19	15¾ × 15	20 × 31½ × 31	3519HP

Optional Items: Glide Caps (Felt, Rubber and Steel).



Note the color needed at the time of ordering • All heights listed are within ¾" variants.

Colors, Guides,
& Accessories
See pages 152-157





Kinect Series – Teacher Desk
Forte Series – Rectangular Table
The Mod Series® – Soft Seating
STAX Curved Bookcase – Single Sided Bookcase
Zed Series – Cantilever Chair & Computer Chair

Kinect Series – Teacher Desk



Connect fluidly with students as Kinect's easy mobility lets you move desk and podium together or separately, with just a touch.

Podium magnetically affixes left, right or stands free. Wide choice of colors in tabletop and band edging.

The most cost-effective way to keep focus where you want it, creating a dynamic class synergy.

Podium features acrylic stopper and key-locked cabinet with 2 shelves and file drawer. All have secure locking casters.

Kinect STYLES



TSKT-2460 - Kinect Mobile Teacher Workstation



TSKT-1924 - Kinect Mobile Teacher Podium



TSKT-2440 - Kinect Mobile Teacher Desk

Kinect Series – Teacher Desk

TOP

Work Surface: 960 Sq. Inches

Tabletop: 1½" fiberboard with high pressure laminate surface. Desk height is 29½".

Pencil Drawer: 21" × 16" featuring compartments for pens and paper clips. This drawer features a ball-bearing suspension.

FRAME

Modesty Panel: 4¾" Modesty panel; 18-gauge perforated panel adds design and comfort.

Legs: Tapered 14-gauge steel legs end with casters and a connecting bar for frame strength.

Caster: 3" swivel locking casters.

PODIUM

Frame: Powder coated steel box. The pedestal is 19½" W × 24" D × 43½" H and is outfitted with four 3" swivel locking casters.

Angled Podium Surface: Attached to a steel heavy-duty post with 2 bolts. Angle of the podium top is 12 degrees.

Locking Drawers: Steel locking door houses two shelves; 1 is height adjustable. Locking file drawer is full extension with ball-bearing suspension. It measures 12½" W × 19" D (13" of easy access space) and 9" H.

HIGH PRESSURE LAMINATE EDGE FINISH



T-Mold
Standard



TSKT-2460 - Kinect Mobile
Teacher Workstation



Strong Magnetic
Connection



Molded Comfort Handles
with concealed magnet



Mobile Podium with Locking
Cabinet & File Drawer



Tilted Podium

Nate Series – Teacher Station



Stunningly sleek, the Nate Teacher Station has raised the bar of beauty, innovation and adaptability.

Roomy, locking storage; file drawers. Casters allow return to swing in or out. Modesty panel for teacher comfort.

Built-in mobile podium can be raised, lowered or tilted. Retractable return increases desktop space as needed.

Enhancements include threaded inserts in tabletop, preset with steel into wood tabletop.

Nate STYLES



TSPM-1824 - Podium



TSP-2468 - Right Handed Teacher Station w/ Stationary Podium

Nate Series – Teacher Station



TSPM-2468 - Nate Teacher Station with Mobile Podium
(Shown in custom laminate Formica Myriad Ribbonwood #863)

TOP

Work Surface: 2230 Sq. Inches

Tabletop: 1/8" Fiberboard with High Pressure Laminate Surface

FRAME

Modesty Panel: Powder Coated 18 Gauge Steel

Retractable Return

3 Legs: 2 3/8" Diameter, Powder Coated, 16 Gauge Steel Legs, screwed into Heavy Duty Table Inserts.

Caster/Glide: Inverted Caster for the Inner Pivot Leg & Rubber Lined Glide for the Stationary Leg. Heavy Duty Locking Caster on Pivot Leg

Left or Right Return (LH/RH) Option: Must note if retractable return is wanted on right or left side of the teacher station at the time of ordering. Add LH/RH to the model number.

Podium

Frame: Powder Coated Steel Box

Power Port: Power is on the right or the left or the center of the Mobile Podium only, not the desk, due to the pullout.

Adjustable Podium Top: Ranging from 29-42" High

Angled Podium Surface: Adjusting to 45 Degrees

Locking Drawers: 2 Drawers & 1 Ball Bearing File Drawer

HIGH PRESSURE LAMINATE EDGE FINISH



PVC 3mm
Standard



Tilted Podium



Optional Power Supply for Podium
Available in both Grey and Black



Inset Caster



Heavy Duty Locking Caster

YouTube

Scan to Watch Demo



Optional Items: Power Supply for Podium (2 AC power or 1 AC with 2 USB outlets).

Size & Order Info
See pages 98-99

Colors, Guides,
& Accessories
See pages 152-157

Nate Series – Teacher Desk



Sleek and functional, the Nate Teacher Desk has raised the bar of beauty, innovation and adaptability.

Roomy, locking storage; file drawers. Modesty panel for teacher comfort.

Thick gauges of steel, heavy-duty hardware and durable construction will ensure this desk will last for years of use.

With built-in inverted casters, move around the classroom to adapt to changing teaching styles.

Nate STYLES



TS-3048 - Single Pedestal Desk



TS-3672P - Left Handed Peninsula Desk



TS-3060 - Double Pedestal Desk

Nate Series – Teacher Desk



TS-3060 - Double Pedestal Desk

TOP

Single Pedestal Work Surface: 1420 Sq. Inches

Peninsula Tabletop: 36" Diameter, Rectangular End 30" Deep

Double Pedestal Work Surface: 1788 Sq. Inches

Tabletop: 1 1/8" Fiberboard with High Pressure Laminate Surface

Power Port: Can be placed on the right, left or center of the desk.

FRAME

Modesty Panel: Powder Coated 18 Gauge Steel

2 Legs: 2 3/8" Diameter, Powder Coated, 16 Gauge Steel (Single Pedestal & Peninsula Only)

Pedestal

Single Pedestal: Powder Coated Steel Pedestal

Drawers: 2 Locking Drawers & 1 Ball-Bearing File Drawer

Double Pedestal: 2 Powder Coated Steel Pedestals

Drawers: 4 Locking Drawers & 2 Ball-Bearing File Drawer

Caster: 2 Inverted Casters

HIGH PRESSURE LAMINATE EDGE FINISH



PVC 3mm
Standard

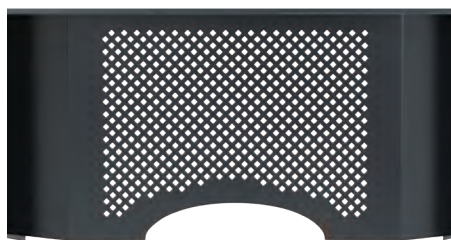

Sleek Modesty Panel



Built In Lock



Drawer Suspension Pull-Out

Optional Items: 2" locking casters (available on Double Pedestal desk), Keyboard Tray, Pencil Tray, Power Supply.

Shown In: TS-3048 & TS-3672P in custom laminate Formica Smokey Brown Pear #5488

Size & Order Info
See pages 98-99

Colors, Guides,
& Accessories
See pages 152-157

Petal Series – Lazer Teacher Desk



Enhances collaborative study environments, completes pod of 6 student desks. Modesty panel and pencil drawer standard.

Arched front for enhanced teacher/student conversation. Comfortably work with multi-student clusters without strain.

Handsome hexagonal, winged design. Long-lasting laminate surface with edge banding complements students' desks.

Easy reconfiguring with gliding casters. Effortlessly move among student groups. Cutting-edge for cooperative education.

Petal Series STYLES



TS-2868 - Lazer Teacher Desk

Petal Series – Lazer Teacher Desk



TS-2868 - Lazer Teacher Desk
(Shown in custom laminate Formica Indigo)

TOP

Work Surface: 1305 Sq. Inches

Tabletop: 1/8" Particleboard Core with a 1/32" High Pressure Laminated Surface, and .020" Poly Backer Sheet Covered Underside

Pencil Drawer: 21" W × 16" D

FRAME

Modesty Panel: 18-Gauge Perforated Panel Extends 15"

Upper Legs: 2" Diameter, 18-Gauge Steel Powder Coated Finish

Insert Legs: 1.875", 16 Gauge Steel, Chrome Plated Finish with Two Self-Locking Screws

Height Adjustable: Legs Adjust In 1" Increments

Caster: Braking Casters Are Standard

HIGH PRESSURE LAMINATE EDGE FINISH



PVC 3mm
Standard

Matching Options



Jr. Petal Desk
See page 52-53



Heavy Duty
Locking Caster

Modesty Panel

TS-2868 - Lazer Teacher Desk
(Shown with 1950 Junior Petal Desk with optional casters)

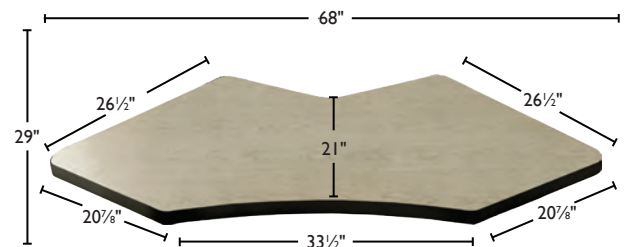

Scan to Watch Demo



Vantage Series – Teacher Desk



Jump-start your collaborative classroom with this comfortable, convenient and easily mobile teacher's desk.

Great vantage point for overview of class. Pick your size and height.

Casters or Glides. Height adjustable or fixed with footrest.

Simple, solid, sensible. Go with the flow of the class. Features modesty panel on all sizes and slide-out pencil drawer.

Vantage STYLES



Fix. Standard Ht.
TVF-2430 - Vantage Teacher Desk
(Shown with optional Casters & Pencil Drawer)



Adj. Standing Ht.
TVSHA-3048 - Vantage Teacher Desk
(Shown with optional Power Supply & Casters)

Vantage Series – Teacher Desk



Standing Fix. Ht.
TVSHF-2430 - Vantage Teacher Desk
(Shown with optional Casters and Cup Holder)

TOP

2430 Work Surface: 700 Sq. Inches

3048 Work Surface: 1420 Sq. Inches

Tabletop: 1½" Particleboard Core with a ½" High Pressure Laminated Surface, and .020" Poly Backer Sheet Underside

FRAME

Unitized Steel Frame: 2" × 1" 18-Gauge Rectangular Tubes

Modesty Panel: 18-Gauge Perforated Steel

Fix. Ht

Foot Rest: 18-Gauge Steel

Adj. Standing Ht

Upper Legs: 1⅞" Diameter 16-Gauge Steel

Insert Legs: Chrome-Plated 2" Round 16-Gauge Steel with Two Self-Locking Screws

Height Adjustable: Legs Adjust In 1" Increments

Casters/Glides: Compatible with Ht. Adj. Glides (Standard) or Casters (Optional)

HIGH PRESSURE LAMINATE EDGE FINISH



T-Mold
Standard



**Optional
Pencil Tray**

Foot Rest



Optional Power Port



Modesty Panel

Optional Items: Casters, Pencil Drawer, Power Port.

Shown In: TVF-2430 in custom laminate Wilsonart Aqua Fizz #4934

Size & Order Info
See pages 98-99

Colors, Guides,
& Accessories
See pages 152-157



Kinect Series – Teacher Desk

Ht."	W × D"	Right Return
Teacher Desk		
29½"	40 × 24"	TSKT-2440
Podium		
43½"	19½ × 24"	TSKT-1924
WorkStation w/ Mobile Podium		
43½"	59½ × 24"	TSKT-2460



Nate Series – Teacher Station

Desk Ht."	W × D"	Right Return	Left Return
Teacher Station w/ Stationary Podium			
29"	68 × 24"	TSP-2468RH	TSP-2468LH
Teacher Station w/ Mobile Podium			
29"	68 × 24"	TSPM-2468-RH	TSPM-2468-LH



Nate Series – Podium

Desk Ht."	W × D"	Model
29"	18½ × 24"	TSPM-1824

Optional Items: Power Supply for Podium (2 AC power or 1 AC with 2 USB outlets).



Nate Series – Teacher Desk

Desk Ht."	W × D"	Model
Single Pedestal		
29"	48 × 30"	TS-3048



Desk Ht."	W × D"	Right Handed, Left Peninsula	Left Handed, Right Peninsula
Peninsula			
29"	72 × 36"	TS-3672P	TS-3672-LH



Desk Ht."	W × D"	Model
Double Pedestal		
29"	60 × 30"	TS-3060

Optional Items: 2" locking casters (available on Double Pedestal desk), Keyboard Tray, Pencil Tray, Power Supply.



Optional Power Port available for all Teachers Desks

Edge Finish & Color Options

Kinect Series

Hydraulically inserted T-Mold edge banding in Black or Gray. Available in colored edge.

Nate Series Teacher Station/Teacher Desk

PVC 3mm edge banding in Black. Driftwood HPL standard edge is Gray. Either Black or Gray can be requested.

See page 154 for more details.

Note the color needed at the time of ordering • All heights listed are within ¾" variants. Casters add 2-3" to the overall height.



Petal Series – Lazer Teacher Desk

Desk Ht."	W × D"	Model
Lazer Teacher Desk		
23-32"	68 × 29"	TS-2868

Vantage Series – Teacher Desk



W × D"	Standard Ht.	Standing Ht.	
30 × 24"	Fix. 29" H	Fix. 42" H	Adj. 33-42" H
48 × 30	TVF-3048	TVSHF-2430	TVSHA-2430
		TVSHF-3048	TVSHA-3048

Optional Items: Casters, Pencil Drawer, Power Port.

Surge Series – School Desk



W × D"	Standard Ht.	
	Adj. 26½-38½" H	Adj. 29-42" H
High Pressure Laminate		
26½ × 24"	1626	1629
Hard-Plastic		
26¾ × 19½"	1626HP	1629HP
WoodStone		
26¾ × 19½"	1626WS	1629WS

**For More Information
See pages 54 - 55 Surge Series**

Optional Items: Backpack Hook, Cup Holder, Mesh Bookbox, and Rubber Glides.

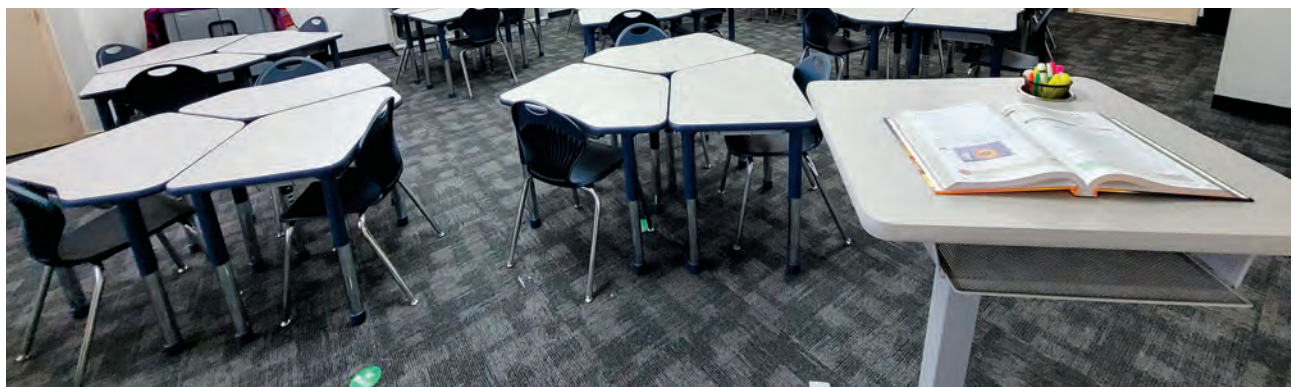

Edge Finish & Color Options

Petal Series Lazer Desk

PVC 3mm edge banding in Black. Driftwood HPL standard edge is Gray. Either Black or Gray can be requested.

Vantage Series

Hydraulically inserted T-Mold edge banding in Black or Gray. Available in colored edge.

See page 154 for more details.

Note the color needed at the time of ordering • All heights listed are within ¾" variants. Casters add 2-3" to the overall height.



KIRKWOOD HIGH SCHOOL - CLARKSVILLE, TN



Power Post
Surge Series – School Desk
Hercules Series – Rectangular Table
Zed Series – Computer Chair & Drafting Stool

Forte Series – Group Study and Activity



Elegant, gentle contour; customized glide matches leg color.

Adaptable height range; glides or casters; enhances every desk or table.

Ample knee space; table leg fits within table-top perimeter.

Unique curvature upgrades roominess; allows full desktop use.

Forte STYLES



FL-36R - Round Table



FL-2448 - Rectangle Table



FL-4872K - Kidney Table



FL-4848CLV - Clover Table

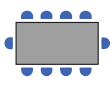

Rectangular
Seats 2-10



Round
Seats 4-8



Trapezoid
Seats 4-5



Square
Seats 4-8



Clover
Seats 4



Flower
Seats 6



Kidney
Seats 5-6*



Horseshoe
Seats 6-8*



Corner
Seats 2



Curved
Seats 6



Squircle
Seats 4

Seat qty. varies depending on dimensions.

*Plus 1 teacher seat

Forte Series – Group Study and Activity



Adj. Standard Ht.
FL-2448 - Rectangle Table
 (Shown in custom laminate Science Lab Chalkboard)

TOP

Tabletop: 1 1/8" thick fiberboard high pressure laminate surface.

FRAME

Stretcher Bar: Underside for extra support. 60" tables and above.

Upper Legs: Powder-coated 1.5" diameter: 16 gauge.

Insert Legs: Powder-coated 1.35" diameter: 16 gauge with two self-locking screws.

Height Adjustable: Adjusts 26-33" with glides. Legs adjust in 1" increments.

Wheelbarrow Option: Available.

Casters/Glides: Ht. Adj. glides (standard) or casters (optional)

HIGH PRESSURE LAMINATE EDGE FINISH



T-Mold
Standard

X-Strong
Optional

PVC 3mm
Optional



Adjustable Legs Compatible with Casters or Glides



Height Adjustable Glide



Underside Frame

Optional Items: Bookboxes, Casters, Grommets, Hooks and Power.

Hercules Series – Group-Study and Activity Table



Hercules legs are strong and sturdy; paired with a 1 1/8" thick fiberboard core with high pressure laminate top.

Powder-coated legs with chrome-plated inserts; two self-locking screws per leg for safety.

The 3/4" bullnose edge-banding is colored to match your choice of nine leg colors.

The sky is the limit with nine leg/edge colors and five laminate colors.

Hercules STYLES



Standard Ht.
HL-4848SQ - Square Table



Toddler Ht.
HLEES-4848CLV - Clover Table



Sushi Ht.
HLEESUS-36R - Round Table
(Shown with 8104 - (4) Pebble Mod®)

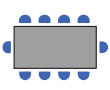

Rectangular
Seats 2-10



Round
Seats 4-8



Trapezoid
Seats 4-5



Kidney
Seats 5-6*



Horseshoe
Seats 6-8*



Square
Seats 4-8



Clover
Seats 4



Flower
Seats 6



Inspiration
Seats 4



Corner
Seats 2



Curved
Seats 6



Squirrel
Seats 4



Half Round
Seats 1

Seat qty. varies depending on dimensions.
*Plus 1 teacher seat

Hercules Series – Group-Study and Activity Table



TOP

Tabletop: 1 1/8" Thick Fiberboard High Pressure Laminate Surface

FRAME

Stretcher Bar: Underside For Extra Support. 60" Tables And Above

Upper Legs: Powder-Coated 2 1/8" Round 18-Gauge Steel

Insert Legs: Chrome-Plated 2" Round 16-Gauge Steel with Two Self-Locking Screws

Height Adjustable: Legs Adjust In 1" Increments

Wheelbarrow Option: Available on Adj. Ht. Tables only. See pages 126-129 for details.

Height Options: Sushi (12-16"), Toddler (17-22") & Standard (23-32")

Casters/Glides: Compatible with Ht. Adj. Glides (Standard) or Casters (Optional)

HIGH PRESSURE LAMINATE EDGE FINISH



HLEE-6060PL - Inspiration Table

(Shown in custom laminate Formica Charcoal Boomerang #6942 with Lime Green Inspiration Chairs)



Adjustable Legs Compatible with Casters or Glides



Height Adjustable Glide



New PVC 3mm Edge (Shown in Primary Green)



New X-Strong Edge



Heavy Duty Support Plate



Stretcher Bar

Optional Items: Bookboxes, Casters, and Grommets.

Size & Order Info
See pages 126-129

Colors, Guides,
& Accessories
See pages 152-157

Harmony Series – Collaborative and Group Study Table



True to its name, Harmony's 4 options conceive a symmetry of interconnections, evoking the tranquility of waves.

Marker Board surface option is great for jotting down thoughts, calculations, diagrams or doodles.

Creating collaboration in traditional classrooms, STEM labs, and libraries; countless configurations.

High pressure laminate with a T-mold edging will hold up no matter how many times you regroup.

Harmony STYLES



Standard Ht.
HS-3052RY - Rhythm



Standard Ht.
HS-3152CD - Chord



Standard Ht.
HS-5252TN - Tone



Standard Ht.
HS-5252ML - Melody



Nesting Table
V2N-3052-RY - Rhythm & V2N-3152-CD - Chord



Rhythm
Seats 4

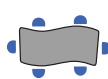

Chord
Seats 6



Tone
Seats 3

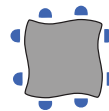

Melody
Seats 8

Seating varies for Rhythm & Chord Nesting Table.

Harmony Series – Collaborative and Group Study Table



HS-5252TN, HS-3152CD & HS-3052RY -
Tone, Chord and Rhythm Configuration

TOP

Tabletop: 1 1/8" Thick Fiberboard High Pressure Laminate Surface

FRAME

Upper Legs: Powder-Coated 2 1/8" Round 18-Gauge Steel Legs

Insert Legs: Chrome-Plated 2" Round 16-Gauge Steel with Two Self-Locking Screws

Height Adjustable: Legs Adjust In 1" Increments

Casters/Glides: Compatible with Ht. Adj. Glides (Standard) or Casters (Optional)

Nesting Table

Stretcher Bar: 2 Rectangular Steel Bars 1 1/2 x 3/4". Torsion Bar Connects The Table Top & Leg Frame Allows for a Slow And Safe Close

Lever Mechanism: Spring Loaded Auto-Lock Handle in Open/Closed Positions

Casters/Glides: Compatible with Casters (Standard) or Ht. Adj. Glides (Optional)

Note: Casters add 2-3" to the overall height.

HIGH PRESSURE LAMINATE EDGE FINISH



Need help configuring in groups?
Request a complimentary puzzle set.



HS-3152CD & HS-3052RY -
Chord and Rhythm Configuration
(Shown in Formica Amarena #6907 and Spectrum Blue #851 with optional Casters)



9CRTWVD-SLIMTRAY-C
Clear or Crystal Tray



Adjustable Legs Compatible with Casters or Glides

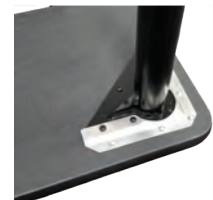

Underside of Table

Optional Items: Casters, and Grommets.

Show In: HS-3052RY in custom laminate Formica Spectrum Blue #851 and HS-5252ML in custom laminate Amarena #6907

Size & Order Info
See pages 126-129

Colors, Guides,
& Accessories
See pages 152-157

Dura Series – Collaborative and Group Study Table



Can handle the toughest of activities. Steel upper frame with legs that are inserted tightly underneath and bolted together. Legs also screw into the table top; total “Durability”.

Adjustable height legs allow both adults and little ones to feel at ease. Also available with fixed leg height.

Choose collaboration with Adam or Chad; Standing height option. Marker Board desktop option for creativity.

Eleven shapes to wow the imagination. Invitingly attractive, Dura lets you customize dynamically.

Dura STYLES



Adj. Standard Ht.
WLA-6066HEE - Horseshoe Dura Table
(Shown with Optional Casters)



Adj. Standard Ht.
WLA-6060FLEE - Flower Dura Table



Fix. Standing Ht.
WLSHF-4848CLVR - Clover Dura Table
(Shown with X-Strong Edge**)



Adj. Standard Ht.
WLA-2460 - Rectangle Dura Table
(Shown with Wheelbarrow Option)



Rectangular
Seats 2-10



Adam
Seats 6



Chad
Seats 6



Round
Seats 4-8



Trapezoid
Seats 4-5



Kidney
Seats 5-6*



Horseshoe
Seats 6-8*



Square
Seats 4-8



Clover
Seats 4



Flower
Seats 6



Squircle
Seats 4

Seat qty. varies depending on dimensions.
*Plus 1 teacher seat

Dura Series – Collaborative and Group Study Table



Adj. Standard Ht.
WLA-6060ADEE - **Adam Dura Table**
(Shown with Squircle® Active Seating Stool)

TOP

Tabletop: 1½" Thick Fiberboard High Pressure Laminate Surface

FRAME

Fully Welded, Unitized Frame: 2" x 1" Rectangular 16-Gauge Steel Frame welded to 1½" Round 16-Gauge Steel Legs

Upper Legs: Available in Black or Tungsten Color

Insert Legs: Chrome-Plated 2" Round 16-Gauge Steel

Height Adjustable: Legs Adjust In 1" Increments

Height Options: Available In Four Height Variations

Wheelbarrow Option: Available on Adj. Ht. Tables only. See pages 126-129 for details.

Casters/Glides: Compatible with Ht. Adj. Glides (Standard) or Casters (Optional)

Note: Casters add 2-3" to the overall height.

HIGH PRESSURE LAMINATE EDGE FINISH



Fix. Standing Ht.
WLSHF-4848CLVR - **Clover Dura Table**
(Shown with X-Strong Edge** & Z430 - Zed Café Stool)



Fix. & Adj. Option



New PVC 3mm Edge
(Shown in Primary Green)



New X-Strong Edge

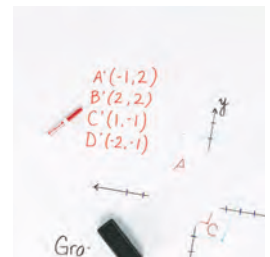

Marker-Board Table Top Option



Fully Welded Strong Unitized Frame

Optional Items: Casters and Power Port

Shown In: WLSHF-4848CLVR in custom Gray Graphite Chem Res HPL

Size & Order Info
See pages 126-129

Colors, Guides,
& Accessories
See pages 152-157

Activity Series – Group-Study and Activity Table



High-pressure laminate top and 1 1/8" - thick fiberboard core. Heavy-gauge steel legs; underside mounting brackets.

Powder-coated legs with chrome-plated inserts adjust in 1" increments; two self-locking screws for safety.

Standard black or gray edge banding, or choose from Educational Edge colors; 3/4" bullnose resists chipping.

Table surface available in your choice of five laminate options. Additional colors available upon request.

Activity STYLES



Standard Ht.
ALEE-4848CLV - Clover Activity Table



Toddler Ht.
ALS-2448TR - Trapezoid Activity Table

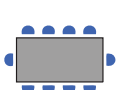

Rectangular
Seats 2-10



Round
Seats 4-8



Trapezoid
Seats 4-5



Kidney
Seats 5-6*



Horseshoe
Seats 6-8*



Square
Seats 4-8



Clover
Seats 4



Flower
Seats 6



Squircle
Seats 4



Half Round
Seats 1

Seat qty. varies depending on dimensions.

*Plus 1 teacher seat

Activity Series – Group-Study and Activity Table



Standard Ht
AL-2448 - **Rectangular Activity Table**
(Shown in standard laminate Driftwood)

TOP

Tabletop: 1/8" Thick Fiberboard High Pressure Laminate Surface

FRAME

Stretcher Bar: Underside For Extra Support. 60" Tables And Above

Upper Legs: 1 1/8" Outer-Diameter Powder-Coated 18-Gauge Steel with Underside Mounting Plate

Insert Legs: Chrome-Plated 1" Outer-Diameter 16-Gauge with Two Self-Locking Screws

Height Adjustable: Legs Adjust In 1" Increments

Glides: Self-leveling Nylon Glides

HIGH PRESSURE LAMINATE EDGE FINISH



T-Mold
Standard



X-Strong
Optional



PVC 3mm
Optional



Standard Ht
ALEE-6060FL - **Flower Activity Table**

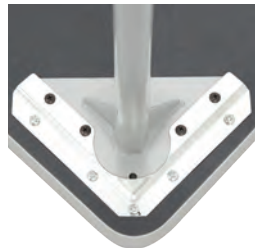

Underside Mounting Plate



Underside View



Stretcher Bar

Optional Items: Bookboxes, Glide Caps (Felt, Rubber and Steel), Grommets, and Power Port.

Shown In: ALS-2448TR in custom laminate Formica Gray Joseph Linen #6325

Size & Order Info
See pages 126-129

Colors, Guides,
& Accessories
See pages 152-157



COLEGIO MARISTA GUAYNABO - GUAYNABO, PR



Demonstration Series – STEM Table
Zed Series – School Chair & Boost Café Stool

Demonstration Series – STEM Table



Fully welded steel frame engineered to withstand the most hands-on classroom training.

Science, technology, engineering or kitchens, this table fits right in.

Sit or stand, you choose! This table was designed with comfort in mind. Four height variations are available.

Perfect for all STEM & Culinary environments. Choice of Butcher Block, Epoxy, Stainless Steel or Phenolic tops.

Demonstration STYLES



Fix. Standard Ht.
DHFP-3060 - Phenolic
Demonstration Table
(Shown with standard glides)



Adj. Standing Ht.
DHSHABB-3060 - Butcher Block
Demonstration Table
(Shown with optional casters)



Adj. Standing Ht.
DHSHABB-4260 - Butcher Block
Demonstration Table
(Shown with Standard Glides)

Demonstration Series – STEM Table



Fix. Standing Ht.
DHSHFBB - Butcher Block
Demonstration Table
(Shown with optional casters)

TOP

Phenolic: ¾". Chemical Resistant- infuses an additional barrier that resists a variety of acids, solvents and general reagents.

Epoxy: Epoxy resin is commonly used in laboratories, and has a high level of heat resistance.

Butcher Block: 1¾". Top offers a rugged yet yielding surface for precision tools. Face-glued Hardwood Strips Coated with Catalyzed Clear Lacquer, 2 top coats and 1 bottom.

FRAME

Fully Welded, Unitized Frame: 2" x 1" Rectangular 18-Gauge Steel Frame Welded to 1½" Round 16-Gauge Steel Legs

Foot Rest: Fully Welded 18-Gauge Steel

Adj. Ht. Tables

Upper Legs: 18-gauge steel Hercules style upper legs are welded to the frame by means of full contact welds.

Insert Legs: 16- Gauge Insert Legs

Height Adjustable: 23-32" H

Wheelbarrow Option: Available on Adj. Ht. Tables only. See pages 126-129 for details.

Height Options: Available In Four Height Variations

Casters/Glides: Compatible with Ht. Adj. Glides (Standard) or Heavy Duty Total Lock Casters (Optional)

Note: Casters add 2-3" to the overall height.



Double Foot Rest
Optional Casters



Phenolic Tabletop
Great For Labs



Stainless Steel Work
Surface Available Option

Optional Items: Casters & Stainless Steel Tabletops.

Size & Order Info
See pages 126-129

Colors, Guides,
& Accessories
See pages 152-157

Demonstration Series – STEM Workstation



Strong laminate options, including custom Chem Res HPL and X-Strong Edge. Wide array of color choices.

Locking casters - easy and lightweight for mobility. Glide for quick rearranging or clean-up.

Alternating concave and convex curves; maximizes leg room and workspace for today's hands-on learning.

Work surface accommodates 4 - sitting or standing. Highly customizable with adj. shelving, tote bins.

Demonstration STYLES



DW42-5252 - STEM Work Station with Shelves



DWC42-5252 - STEM Work Station with Tote Bins



TBC-4342 - Tote Bin Cabinet (Shown with optional Clear Bins)

Demonstration Series – STEM Workstation



DWC42-5252 - **STEM Work Station**
(Shown in custom laminate Formica Burnt Strand
with Z58D - Drafting Stool)

TOP

Work Surface: 2702 Sq. Inches

Tabletop: 52 × 52" Collaborative Shaped Top,
1½" thick.

Color: HPL Top available in all 7 standard laminate colors.

FRAME

STEM Work Station

Cabinet Base: ¾" thick HPL. 4 individual cabinets, with doors for each side of the unit. The cabinet is 33" W × 33" D.

Color: Base cabinet is available in 6 of the standard HPL colors (not White Markerboard) and White (Wilsonart-Designer White), Graphite (Wilsonart-Slate Gray) and Light Gray (Wilsonart- Dove Gray).

Storage: Tote Bins or Shelves

Height Options: Available in Three Height Options

Casters: Heavy Duty Curved Casters (Standard)

Tote Bin Cabinet

Frame: 1½" thick HP Laminate with 3MM PVC banding constructed with dowel holes and pins

Storage: 27 Tote Bins

Casters: Heavy Duty Curved Casters (Standard)

Tote Bin

Compatible With: Demonstration Series STEM Work Station, Tote Bin Cabinet, Desks and Tables.
Color options available on page 156

HIGH PRESSURE LAMINATE EDGE FINISH



T-Mold
Standard

1 of 4
Individual Cabinets



4" Total Lock Heavy
Duty Casters



DWCS42-5252 - **STEM Work Station**
with Shelves & Tote Bins



Tote Bin is convenient for
keeping supplies close by for
immediate access.

Optional Items: Clear Bins, Shelves or Tote Bins.

Shown In: DW42-5252, DWC42-5252 & DWCS42-5252 in custom Chem Res HPL.

Size & Order Info
See pages 126-129

Colors, Guides,
& Accessories
See pages 152-157

Illustration V2 Series – Seminar and Computer Table



The table can be used in any setting, thanks to the legs, which can be adjusted to heights from 26"-31".

The soft curves of the upper leg supports and dual legs on either side make this table the design of the future.

The 1150+ square inch tabletop is designed to provide plenty of room for displays, keyboards, mouse and accessories.

The unitized frame is self-supporting, meaning that the table is held together by heavy-gauge steel, not by the top.

Illustration V2 STYLES



Fix. Ht.
V2F-2460 - Illustration V2
Seminar Table



Adj. Ht.
V2CO-2460 - Illustration V2
Computer Table



Fix. Ht.
V2N-3060 - V2N
Nesting Table



Fix. Ht.
V2NMP-3060 - V2N Nesting
Table with Modesty Panel

Illustration V2 Series – Seminar and Computer Table



Fix. Ht.
V2NMP-3060 - V2N Nesting Table with Modesty Panel
(Shown with Zed Cantilever Chair)

TOP

Tabletop: 1 1/4" Fiberboard High-Pressure Laminate Surface

Grommets: Standard Grommets for Computer Table

FRAME

Illustration V2

Welded Connection: 1" Steel Tube, 12-Gauge Steel, welded to 1 1/4" Diameter 18 Gauge Steel Stretcher Bar

Wire Management: Available on Computer Table

Fix. Ht. Illustration V2 Table

Legs: Two 1 1/2" Diameter Tubes 16-Gauge Steel

Adj. Ht. Illustration V2 Table

Upper Legs: Two 1 1/2" Diameter Tubes 16-Gauge Steel

Insert Legs: Two 1 1/2" Diameter, 16-Gauge Steel Chrome Legs with Two Self-Locking Screws

Height Adjustable: Legs Adjust In 1" Increments

V2N Nesting Table

Stretcher Bar: 2 Rectangular Steel Bars 1 1/2" x 3/4". Torsion Bar Connects The Table Top & Leg Frame Allows for a Slow And Safe Close

Lever Mechanism: Spring Loaded Auto-Lock Handle in Open/Closed Positions

Modesty Panel (V2NMP): Available on Nesting Tables

Casters/Glides: Compatible with Casters (Standard) or Ht. Adj. Glides (Optional)

Note: Casters add 2-3" to the overall height.

HIGH PRESSURE LAMINATE EDGE FINISH



Unitized Frame

Close when not in use for more space!



One Hand Lever Mechanism



V2N Nesting Table Group
w/ Modesty Panel

Matching Options



Illustration V2 Desk
See page 56-57

Optional Items: Casters (Standard on all V2N), Grommets, Keyboard Trays, Wire Management, and Rubber Glides. Modesty Panel optional on V2N.

Shown In: V2F-2460, V2CO-2460 & V2N-3060 in custom laminate Pionite Chocolate Malt #WC210



PASSAIC ARTS AND SCIENCE CHARTER SCHOOL - PASSAIC, NJ



Nate Series – Teacher Desk
Dura Series – Rectangle Table
Demonstration Series – Tote Bin Cabinet
STAX Bookcase – Single Sided Bookcase

C-Leg Series – Computer Table



Traditionally designed table features a modern looking perforated modesty panel. Built-in wire management.

Available in many widths and depths to accommodate varying numbers of students and a full array of computer equipment.

To make the most of these tables, we've included grommets and choice of optional keyboard trays and computer holders.

Perforated modesty panel allows for improved airflow.

C-Leg STYLES



CL-2448 - Computer Table
(Optional with Casters)



CL-2436 - Computer Table

C-Leg Series – Computer Table



CL-2448 - Computer Table

(Shown in custom Nevamar #WM0047 Tabletop with optional Power Port)

TOP

Tabletop: 1 1/8" Thick Fiberboard High-Pressure Laminate Surface

Grommets: Standard Grommets for Computer Table

Grommets and wire management are standard on all C-Leg tables.

Depending on the width, one, two or three computer workstations can comfortably fit on each table. See the chart on page 157 for more information.

FRAME

Frame: 17-Gauge Black Powder-Coated Rectangular Tubing 1 1/2" x 2 1/4"

Wire Management*: 18-Gauge Modesty Panel With Built-In Wire Management Tray

Glides: Height Adjustable Screw-In Nylon Glides

Note: Casters add 2-3" to the overall height.

HIGH PRESSURE LAMINATE EDGE FINISH



T-Mold
Standard



X-Strong
Optional



PVC 3mm
Optional



Built-In Wire Management & Modesty Panel



Optional Keyboard Tray

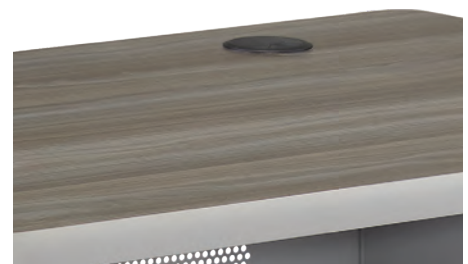

Grommet Holes

Optional Items: Casters, Connector Bridge, Keyboard Tray, Power Supply and Rubber Glides.

Size & Order Info
See pages 126-129

Colors, Guides,
& Accessories
See pages 152-157

T-Leg Series – Computer and Seminar Table



Designed to be durable yet inexpensive. Wide selection of widths, depths and surface colors.

Features a sturdy T-leg design which is secured by three self-locking screws and adjustable to heights from 22" to 33".

A unitized frame makes these tables very sturdy. Larger tabletops include stretcher bars for added strength.

Keyboard tray, computer holders and wire-management trays can be added to any table in this series.

T-Leg STYLES



TL-2448 - Seminar Table
(Shown with optional Casters)



TLG-2460 - T-Leg Computer Table with Grommets
(Shown with optional Keyboard Trays and Wire Management Tray)



ADA Option Available

T-Leg Series – Computer and Seminar Table



TLG-2460 - T-Leg Computer Table with Grommets
(Shown in custom laminate Wilsonart Beigewood #7850 with optional Keyboard Trays and Wire Management Tray.)

TOP

Tabletop: 1/8" Thick Fiberboard High-Pressure Laminate Surface

Grommets: Standard for Computer Table

Depending on the width, one, two or three computer workstations can comfortably fit on each table. See the chart on page 157 for more information.

FRAME

Upper Legs: 16-Gauge Black Powder-Coated Rectangular Tubing 1 1/8"W x 2 1/8"D

Insert Legs: 16-Gauge Chrome-Plated Rectangular Tubing with Three Self-Locking Screws. 1"W x 2"D

Wire Management: Optional on Computer Table

Height Adjustable: Legs Adjust In 1" Increments

Glides: Height Adjustable Screw-In Nylon Glides

ADA Option Available

T-Leg Tables are only available in Black Frame Finish.

HIGH PRESSURE LAMINATE EDGE FINISH



T-Mold
Standard



X-Strong
Optional



PVC 3mm
Optional

Matching Options



T-Leg Desk
See page 58-59



T-Leg With
Three Screws



Stretcher Bar & Corner Braces

Optional Items: Grommets, Casters, Wire Management, and Keyboard Trays

Size & Order Info
See pages 126-129

Colors, Guides,
& Accessories
See pages 152-157

CLASSROOMTABLE



Forte Series - Group Study and Activity Table

W × D"	Standard (26-33"H)
Rectangular	
36 × 24"	FL-2436
48 × 24	FL-2448
60 × 24	FL-2460
72 × 24	FL-2472
36 × 30	FL-3036
48 × 30	FL-3048
60 × 30	FL-3060
72 × 30	FL-3072
48 × 36	FL-3648
60 × 36	FL-3660
72 × 36	FL-3672
Round	
36 × 36"	FL-36R
42 × 42	FL-42R
48 × 48	FL-48R
60 × 60	FL-60R
Trapezoid	
48 × 24"	FL-2448TR
60 × 30	FL-3060TR
Square	
36 × 36"	FL-3636SQ
48 × 48	FL-4848SQ
Clover	
48 × 48"	FL-4848CLV
Flower	
60 × 60"	FL-6060FL
Kidney	
72 × 36"	FL-3672K
72 × 48	FL-4872K
Horseshoe	
66 × 60"	FL-6066H
Corner	
60 × 24"	FL-2460CNR
Curved	
54 × 42"	FL-4254CUR
Squirrel	
42 × 42"	FL-4242SQCL

Optional Items: Bookboxes, Casters hard or soft, grommets, hooks and power.

Wheelbarrow Option: Available for all rectangle shaped adjustable height tables. When ordering wheelbarrow option, order 1 set of casters per 2 tables.



Hercules Series – Group-Study and Activity Table

W × D"	Standard (23-32"H)	Toddler (17-22"H)	Sushi (12-16"H)
Rectangular			
36 × 24"	HL-2436	HLS-2436	HLSUS-2436
48 × 24	HL-2448	HLS-2448	HLSUS-2448
60 × 24	HL-2460	HLS-2460	HLSUS-2460
72 × 24	HL-2472	HLS-2472	HLSUS-2472
48 × 30	HL-3048	HLS-3048	HLSUS-3048
60 × 30	HL-3060	HLS-3060	HLSUS-3060
72 × 30	HL-3072	HLS-3072	HLSUS-3072
60 × 36	HL-3660	HLS-3660	HLSUS-3660
72 × 36	HL-3672	HLS-3672	HLSUS-3672
Round			
36 × 36"	HL-36R	HLS-36R	HLSUS-36R
42 × 42	HL-42R	HLS-42R	HLSUS-42R
48 × 48	HL-48R	HLS-48R	HLSUS-48R
60 × 60	HL-60R	HLS-60R	HLSUS-60R
Trapezoid			
24 × 48"	HL-2448TR	HLS-2448TR	HLSUS-2448TR
30 × 60	HL-3060TR	HLS-3060TR	HLSUS-3060TR
Kidney			
72 × 36"	HL-3672K	HLS-3672K	HLSUS-3672K
72 × 48	HL-4872K	HLS-4872K	HLSUS-4872K
Horseshoe			
60 × 66"	HL-6066H	HLS-6066H	HLSUS-6066H
Square			
36 × 36"	HL-3636SQ	HLS-3636SQ	HLSUS-3636SQ
48 × 48	HL-4848SQ	HLS-4848SQ	HLSUS-4848SQ
Clover			
48 × 48"	HL-4848CLV	HLS-4848CLV	HLSUS-4848CLV
Flower			
60 × 60"	HL-6060FL	HLS-6060FL	HLSUS-6060FL
Inspiration			
60 × 60"	HL-6060PL	HLS-6060PL	HLSUS-6060PL
Corner			
60 × 24"	HL-2460CNR	HLS-2460CNR	HLSUS-2460CNR
Curved			
54 × 42"	HL-4254CUR	HLS-4254CUR	HLSUS-4254CUR
Squirrel			
36 × 36"	HL-3636SQCL	HLS-3636SQCL	HLSUS-3636SQCL
Half Round			
48 × 24"	HL-2448HRD	HLS-2448HRD	HLSUS-2448HRD

Optional Items: Bookboxes, Casters, and Grommets.

Wheelbarrow Option: Available for all rectangular shaped adjustable height tables. When ordering wheelbarrow option, order 1 set of casters per 2 tables.

Edge Finish & Color Options

Forte Series

Standard: Hydraulically inserted T-Mold edge banding in Black or Gray.

Optional: Colored T-Mold edge.

Optional X-Strong Finish and PVC 3mm Finish: Are available in all standard and colored edge options.

Hercules Series

Standard: Hydraulically inserted T-Mold edge banding in Black or Gray.

Optional Educational Edge (EE): Color coordinated edge banding and legs are available for Standard and Toddler Height. Sushi height legs are only available in Black or Gray.

Optional X-Strong Finish and PVC 3mm Finish: Are available in all standard and Educational Edge colors.

See page 154 for more details.

Note the color needed at the time of ordering • All heights listed are within 3/4" variants. Casters add 2-3" to the overall height.



Harmony Series – Collaborative and Group Study Table

W x D"	Standard (23-32"H)	Toddler (17-22"H)	Sushi (12-16"H)
Rhythm			
52 x 30"	HS-3052RY	HSS-3052RY	HSSUS-3052RY
Chord			
52 x 31"	HS-3152CD	HSS-3152CD	HSSUS-3152CD
Tone			
52 x 52"	HS-5252TN	HSS-5252TN	HSSUS-5252TN
Melody			
52 x 52"	HS-5252ML	HSS-5252ML	HSSUS-5252ML



W x D"	Nesting Table Fix. (29" H)
Rhythm	
52 x 30"	V2N-3052RY
Chord	
52 x 31"	V2N-3152CD

Optional Items: Casters, and Grommets.

Table Shape



Dura Series – Collaborative and Group Study Table

W x D"	Standard Ht.		Standing Ht.	
	Adj. 23-32" H	Fix. 29½" H	Adj. 33-42" H	Fix. 42" H
Rectangular				
48 x 20"	WLA-2048	WLF-2048	WLSHA-2048	WLSHF-2048
60 x 20"	WLA-2060	WLF-2060	WLSHA-2060	WLSHF-2060
72 x 20"	WLA-2072	WLF-2072	WLSHA-2072	WLSHF-2072
36 x 24"	WLA-2436	WLF-2436	WLSHA-2436	WLSHF-2436
48 x 24"	WLA-2448	WLF-2448	WLSHA-2448	WLSHF-2448
60 x 24"	WLA-2460	WLF-2460	WLSHA-2460	WLSHF-2460
72 x 24"	WLA-2472	WLF-2472	WLSHA-2472	WLSHF-2472
36 x 30"	WLA-3036	WLF-3036	WLSHA-3036	WLSHF-3036
48 x 30"	WLA-3048	WLF-3048	WLSHA-3048	WLSHF-3048
60 x 30"	WLA-3060	WLF-3060	WLSHA-3060	WLSHF-3060
72 x 30"	WLA-3072	WLF-3072	WLSHA-3072	WLSHF-3072
60 x 36"	WLA-3660	WLF-3660	WLSHA-3660	WLSHF-3660
72 x 36"	WLA-3672	WLF-3672	WLSHA-3672	WLSHF-3672
60 x 42"	WLA-4260	WLF-4260	WLSHA-4260	WLSHF-4260
Adam				
60 x 60"	WLA-6060AD	WLF-6060AD	WLSHA-6060AD	WLSHF-6060AD
Chad				
60 x 42"	WLA-4260CH	WLF-4260CH	WLSHA-4260CH	WLSHF-4260CH
Round				
36 x 36"	WLA-36R	WLF-36R	WLSHA-36R	WLSHF-36R
42 x 42"	WLA-42R	WLF-42R	WLSHA-42R	WLSHF-42R
48 x 48"	WLA-48R	WLF-48R	WLSHA-48R	WLSHF-48R
60 x 60"	WLA-60R	WLF-60R	WLSHA-60R	WLSHF-60R
Trapezoid				
24 x 48"	WLA-2448TR	WLF-2448TR	WLSHA-2448TR	WLSHF-2448TR
30 x 60"	WLA-3060TR	WLF-3060TR	WLSHA-3060TR	WLSHF-3060TR
Kidney				
72 x 36"	WLA-3672K	WLF-3672K	WLSHA-3672K	WLSHF-3672K
72 x 48"	WLA-4872K	WLF-4872K	WLSHA-4872K	WLSHF-4872K
Horseshoe				
60 x 66"	WLA-6066H	WLF-6066H	WLSHA-6066H	WLSHF-6066H
Square				
48 x 48"	WLA-4848SQ	WLF-4848SQ	WLSHA-4848SQ	WLSHF-4848SQ
Clover				
48 x 48"	WLA-4848CLVR	WLF-4848CLVR	WLSHA-4848CLVR	WLSHF-4848CLVR
Flower				
60 x 60"	WLA-6060FL	WLF-6060FL	WLSHA-6060FL	WLSHF-6060FL
Squircle				
36 x 36"	WLA-3636SQCL	WLF-3636SQCL	WLSHA-3636SQCL	WLSHF-3636SQCL

Optional Items: Casters and Power Port

Wheelbarrow Option: Available for all rectangular shaped adjustable height tables. When ordering wheelbarrow option, order 1 set of casters per 2 tables.

Edge Finish & Color Options

Harmony Series

Standard: Hydraulically inserted T-Mold edge banding in Black or Gray.

Optional Educational Edge (EE): Color coordinated edge banding and legs are available for Standard and Toddler Height. Sushi height legs and Nesting tables are only available in Black or Gray.

Optional X-Strong Finish and PVC 3mm Finish: Are available in all standard and Educational Edge colors.

Dura Series

Standard: Hydraulically inserted T-Mold edge banding in Black or Gray.

Optional: Colored T-Mold edge.

Optional X-Strong Finish and PVC 3mm Finish: Are available in all standard and colored edge options.

See page 154 for more details.

Note the color needed at the time of ordering • All heights listed are within ¾" variants. Casters add 2-3" to the overall height.





Activity Series – Group-Study and Activity Table

W × D"	Standard (23-31" H)	Toddler (17-22" H)
Rectangular		
30 × 24"	AL-2430	ALS-2430
36 × 24"	AL-2436	ALS-2436
48 × 24"	AL-2448	ALS-2448
60 × 24"	AL-2460	ALS-2460
72 × 24"	AL-2472	ALS-2472
48 × 30"	AL-3048	ALS-3048
60 × 30"	AL-3060	ALS-3060
72 × 30"	AL-3072	ALS-3072
60 × 36"	AL-3660	ALS-3660
72 × 36"	AL-3672	ALS-3672
Round		
36 × 36"	AL-36R	ALS-36R
42 × 42"	AL-42R	ALS-42R
48 × 48"	AL-48R	ALS-48R
60 × 60"	AL-60R	ALS-60R
Trapezoid		
24 × 48"	AL-2448TR	ALS-2448TR
30 × 60"	AL-3060TR	ALS-3060TR
Kidney		
72 × 36"	AL-3672K	ALS-3672K
72 × 48"	AL-4872K	ALS-4872K
Horseshoe		
60 × 66"	AL-6066H	ALS-6066H
Square		
36 × 36"	AL-3636SQ	ALS-3636SQ
48 × 48"	AL-4848SQ	ALS-4848SQ
Clover		
48 × 48"	AL-4848CLV	ALS-4848CLV
Flower		
60 × 60"	AL-6060FL	ALS-6060FL
Squirrel		
36 × 36"	AL-3636SQCL	ALS-3636SQCL
Half Round		
48 × 24"	AL-2448HRD	ALS-2448HRD

Optional Items: Bookboxes, Glide Caps (Felt, Rubber and Steel), Grommets, and Power Port.



Demonstration Series – STEM Table

W × D"	Standard Ht.		Standing Ht.	
	Adj. 23-32" H	Fix. 29½" H	Adj. 33-42" H	Fix. 42" H
Butcher Block Top				
60 × 24"	DHABB-2460	DHFBB-2460	DHSHABB-2460	DHSHFBB-2460
60 × 30"	DHABB-3060	DHFBB-3060	DHSHABB-3060	DHSHFBB-3060
60 × 36"	DHABB-3660	DHFBB-3660	DHSHABB-3660	DHSHFBB-3660
60 × 42"	DHABB-4260	DHFBB-4260	DHSHABB-4260	DHSHFBB-4260
Phenolic Top				
60 × 24"	DHAP-2460	DHFP-2460	DHSHAP-2460	DHSHFP-2460
60 × 30"	DHAP-3060	DHFP-3060	DHSHAP-3060	DHSHFP-3060
60 × 36"	DHAP-3660	DHFP-3660	DHSHAP-3660	DHSHFP-3660
60 × 42"	DHAP-4260	DHFP-4260	DHSHAP-4260	DHSHFP-4260
Epoxy Top				
60 × 24"	DHAE-2460	DHFE-2460	DHSHAE-2460	DHSHFE-2460
60 × 30"	DHAE-3060	DHFE-3060	DHSHAE-3060	DHSHFE-3060
60 × 36"	DHAE-3660	DHFE-3660	DHSHAE-3660	DHSHFE-3660
60 × 42"	DHAE-4260	DHFE-4260	DHSHAE-4260	DHSHFE-4260

Optional Items: Casters & Stainless Steel Tabletops.

Wheelbarrow Option: Available for all rectangular shaped adjustable height tables. When ordering wheelbarrow option, order 1 set of casters per 2 tables.

Demonstration Series – STEM Workstation

Table Ht.	W × D"	Bins/Side	Shelves	Model
With Tote Bins*				
30"	52 × 52"	3	—	DWC30-5252
36"	52 × 52"	4	—	DWC36-5252
42"	52 × 52"	6	—	DWC42-5252
Mix of Tote Bins*/Shelves				
30"	52 × 52"	3	1	DWCS30-5252
36"	52 × 52"	4	2	DWCS36-5252
42"	52 × 52"	6	2	DWCS42-5252
With Shelves				
30"	52 × 52"	—	1	DW30-5252
36"	52 × 52"	—	2	DW36-5252
42"	52 × 52"	—	2	DW42-5252

Demonstration Series – Tote Bin Cabinet

Ht.	W × D"	Bins	Shelves	Model
42"	43 × 13"	27	—	TBC-4342

Optional Items: Clear Bins, Shelves or Tote Bins.

*Color options for Tote Bins are available on page 156

Edge Finish & Color Options

Activity Series

Standard: Hydraulically inserted T-Mold edge banding in Black or Gray.

Optional Educational Edge (EE): Color coordinated edge banding and legs are available for Standard and Toddler Height.

Optional X-Strong Finish and PVC 3mm Finish: Are available in all standard and Educational Edge colors.

Demonstration Series – STEM Workstation

Standard: Hydraulically inserted T-Mold edge banding in Black or Gray. Colored edge is optional.

See page 154 for more details.

Note the color needed at the time of ordering • All heights listed are within ¾" variants. Casters add 2-3" to the overall height.

Illustration V2 Series – Seminar Table

W × D"	Adj. 27½-31½" H	Fix. 29" H
Seminar Table		
48 × 20"	V2A-2048	V2F-2048
60 × 20	V2A-2060	V2F-2060
72 × 20	V2A-2072	V2F-2072
36 × 24	V2A-2436	V2F-2436
48 × 24	V2A-2448	V2F-2448
60 × 24	V2A-2460	V2F-2460
72 × 24	V2A-2472	V2F-2472
36 × 30	V2A-3036	V2F-3036
48 × 30	V2A-3048	V2F-3048
60 × 30	V2A-3060	V2F-3060
72 × 30	V2A-3072	V2F-3072



W × D"	Adj. 27½-31½" H	Fix. 29" H
Nesting Table Fixed		
48 × 24"	—	V2N-2448
60 × 24	—	V2N-2460
72 × 24	—	V2N-2472
48 × 30	—	V2N-3048
60 × 30	—	V2N-3060
72 × 30	—	V2N-3072



W × D"	Adj. 27½-31½" H	Fix. 29" H
Nesting Table Fixed w/ Modesty Panel		
48 × 24"	—	V2NMP-2448
60 × 24	—	V2NMP-2460
72 × 24	—	V2NMP-2472
48 × 30	—	V2NMP-3048
60 × 30	—	V2NMP-3060
72 × 30	—	V2NMP-3072



Illustration V2 Series – Computer Table

W × D"	Adj. 27½-31½" H	Fix. 29" H
Computer Table		
36 × 24"	V2ACO-2436	V2FCO-2436
48 × 24	V2ACO-2448	V2FCO-2448
60 × 24	V2ACO-2460	V2FCO-2460
72 × 24	V2ACO-2472	V2FCO-2472
36 × 30	V2ACO-3036	V2FCO-3036
48 × 30	V2ACO-3048	V2FCO-3048
60 × 30	V2ACO-3060	V2FCO-3060
72 × 30	V2ACO-3072	V2FCO-3072



Optional Items: Casters (Standard on all V2N), Grommets, Keyboard Trays, Wire Management, and Rubber Glides. Modesty Panel optional on V2N.

C-Leg Series – Computer Table

W × D"	Fix. 29½" H
Computer Tables	
30 × 24"	CL-2430
36 × 24	CL-2436
48 × 24	CL-2448
60 × 24	CL-2460
72 × 24	CL-2472
48 × 30	CL-3036
48 × 30	CL-3048
60 × 30	CL-3060
72 × 30	CL-3072



Optional Items: Casters, Connector Bridge, Keyboard Tray, Power Supply and Rubber Glides.

Grommets and wire management are standard on all C-Leg tables. Depending on the width, one, two or three computer workstations can comfortably fit on each table. See the chart on page 157 for more information.

T-Leg Series – Seminar Table

W × D"	Adj. 22½-32½" H	Adj. ADA 30-35" H
Seminar Tables		
36 × 24"	TL-2436	—
48 × 24	TL-2448	TLADA-2448
60 × 24	TL-2460	TLADA-2460
72 × 24	TL-2472	TLADA-2472
36 × 30	TL-3036	—
48 × 30	TL-3048	TLADA-3048
60 × 30	TL-3060	TLADA-3060
72 × 30	TL-3072	TLADA-3072
60 × 36	TL-3660	TLADA-3660
72 × 36	TL-3672	TLADA-3672



T-Leg Series – Computer Table

W × D"	Adj. 22½-32½" H	Adj. ADA 30-35" H
Computer Table		
36 × 24"	TLG-2436	—
48 × 24	TLG-2448	TLGADA-2448
60 × 24	TLG-2460	TLGADA-2460
72 × 24	TLG-2472	TLGADA-2472
36 × 30	TLG-3036	—
48 × 30	TLG-3048	TLGADA-3048
60 × 30	TLG-3060	TLGADA-3060
72 × 30	TLG-3072	TLGADA-3072
60 × 36	TLG-3660	TLGADA-3660
72 × 36	TLG-3672	TLGADA-3672



Optional Items: Grommets, Casters, Wire Management, and Keyboard Trays

T-Leg Tables are only available in Black Frame Finish. Depending on the width, one, two or three computer workstations can comfortably fit on each table. See the chart on page 157 for more information.

Edge Finish & Color Options

Illustration V2 Series

Standard: Hydraulically inserted T-Mold edge banding in Black or Gray.

Optional: Colored T-Mold edge.

Optional X-Strong Finish and PVC 3mm Finish: Are available in all standard and colored edge options.

C-Leg Series & T-Leg Series

Standard: Hydraulically inserted T-Mold edge banding in Black or Gray.

Optional: Colored T-Mold edge.

Optional X-Strong Finish and PVC 3mm Finish: Are available in all standard and colored edge options.

See page 154 for more details.

Note the color needed at the time of ordering • All heights listed are within ¾" variants. Casters add 2-3" to the overall height.



MAGNOLIA SPEECH SCHOOL - MADISON, MS



Zed Series – Computer Chair
The Mod Series® – Soft Seating
Boost Series – Round Café Table
STAX Curved Bookcase – Single Sided Bookcase

STAX Curved Bookcase – Single and Double-Sided Bookcase



Simple, strong and functional. Solid back. Industrial-grade steel frame on all mobile units.

Extra thick shelves and sides endure weight. Fully adjustable shelves with counter sunk holes.

Combine to create “S”, horseshoe, circle or semicircle. Single and double sided options; casters for mobility.

Pair with Arc 6 Mod® to create seating nook or reading section.

STAX Curved Bookcase STYLES



BCURDM-6036 - Stax Curved Double Bookcases



BCURM-6036 - Stax Curved Bookcases

STAX Curved Bookcase – Single and Double-Sided Bookcase



BOOKCASES

Back Surface: ¾" Thick Fiberboard High-Pressure Laminate

Edge-Banding: All standard laminate Bookcases have matching PVC 3mm Edge Banding, except Gray Nebula, which comes standard with Black Edge Banding. Driftwood has Gray Edge Band but can be requested with Black.

Shelf Surface: 1 ½" Thick Fiberboard, High-Pressure Laminate

Adjustable Shelves: Shelves have counter sunk holes for pin support. Dowel holes & pins are held together by L-Brackets screwed in place

White Board Laminate color is not standard on Bookcases.

See page 142 for shelf quantities.

Casters: Heavy Duty Curved Casters

HIGH PRESSURE LAMINATE EDGE FINISH



PVC 3mm
Standard

BCURM-6048 - **Stax Curved Single Bookcases**
(Shown with HLS-4254CUR - Hercules Curved Table & SQ-18 - Squiracle® Stools)

Matching Options



Adjustable Shelves Securely Held by Push Pins



Heavy Duty Locking Casters



Serpentile



Hercules Curved Table
See page 104-105



Arc 6 Mod®
See page 34-35

STAX Bookcase – Single and Double-Sided Bookcase



Single and double sided options, casters for mobility. Create seating nook, reading section, or room divider.

Extra thick shelves and sides endure weight. Fully adjustable shelves with counter sunk holes.

Simple, strong and functional. Solid back. Industrial-grade steel frame on all mobile units.

Simple, strong and functional. Customize colors to match a classroom or media center.

STAX Bookcase STYLES



BCD-3648 - Double-Sided Bookcase



BC-3636 - Single-Sided Bookcase

STAX Bookcase – Single and Double-Sided Bookcase



Stax Bookcases

(Shown in custom laminate Formica White Malachite #9949 Various sizes, available in both single and double-sided)

BOOKCASES

Back Surface: 3/4" Thick Fiberboard High-Pressure Laminate

Edge-Banding: All standard laminate Bookcases have matching PVC 3mm Edge Banding, except Gray Nebula, which comes standard with Black Edge Banding. Driftwood has Gray Edge Band but can be requested with Black.

Shelf Surface: 1/8" Thick Fiberboard, High-Pressure Laminate

Adjustable Shelves: Shelves have counter sunk holes for pin support. Dowel holes & pins are held together by L-Brackets screwed in place. (All bookcases 60" and above have a fixed shelf. Amount of shelves change depending on the overall size of the bookcase.)

White Board laminate color is not standard on Bookcases.

See page 142 for shelf quantities.

Glides: Adjustable Nylon Glides

Mobile Bookcases

Frame: 1" X 1" Fully Welded Square Tubing

Casters: 3" Heavy Duty Casters (Double Mobile Bookcases Only)

HIGH PRESSURE LAMINATE EDGE FINISH



PVC 3mm
Standard



Adjustable Shelves Securely Held by Push Pins



Self-Leveling Glides



Heavy-Duty Steel Frame



KIRKWOOD HIGH SCHOOL - CLARKSVILLE, TN



Boost Series – Round Café Tables & Zed Café Stools

Boost Series – Café Tables & Stools



Comfortable café ambience lets students work and collaborate. Recharge devices and revitalize readiness for class.

4 tabletop shapes, including the Squircle shape. 7 standard colors; custom colors available.

Appealing café height table with curved chairs calls kids to come relax, connect, unwind.

Strong and sturdy with foot rest for secure sitting. Full contact weld holds up to years of wear.

Boost STYLES



Toddler 18" Ht.
Regular Base



Standard 30" Ht.
Regular or Quad Base



Jr Standing 36" Ht.
Regular Base



Standing 42" Ht.
Regular or Quad Base



Z430G - 30" Zed
Café Stool



Z424G - 24" Zed
Café Stool

Round Table
Regular or Quad Base



30"



36"



42"

Square Table
Regular or Quad Base



30 x 30"



36 x 36"

Squircle Table
Quad Base



36 x 36"

Oval Table
Regular or Quad Base



36 x 60"

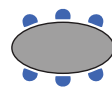

36 x 72"

Oval not available in Toddler Ht.

Boost Series – Café Tables & Stools



QCF-3636SQCL - 30" Ht. Squirrelle Quad Café Tables

SEATING

Shell: One-Piece, Color-Impregnated Polypropylene Molded Plastic with Built-in Carry Handle

Back: Integral Lumbar Supports & Smooth Back

Steel Legs: Fully Unitized 14-Gauge, 1" Diameter

Steel Foot Rest: Angled 14-Gauge, 3/4" Diameter

Steel Legs and Foot Rest available in Chrome-Plated, Gray (G) Powder Coating or Black (B) Powder Coating

Glides: Self Leveling Nylon Glides

TABLE

Tabletop: 1 1/2" Particleboard Core 1/2" High Pressure Laminated

Backer Sheet: Underside .020" Poly

Upper Frame: Four 16-Gauge Plate Attached to Tabletop by 16 Screws. 1 1/2" upper steel support.

Frame Finish: Available in Black or Tungsten

Legs: 16 Gauge, 1 1/4" Diameter

Post: 3" Dia.

Base

Regular Base: 12-Gauge, 22" Dia.

Quad Base: 30" Dia. Only available in Tungsten Gray.

Glides: Adjustable 2" Rubber Glide

HIGH PRESSURE LAMINATE EDGE FINISH



T-Mold
Standard

X-Strong
Optional

PVC 3mm
Optional



CFSH-3672OV & 7430 - Oval Table and Inspiration Boost Stool



Regular Base



Quad Base



Adjustable Glide



Optional Power Port

Optional Items: Power Port, Glide Caps (Felt, Rubber and Steel)

Size & Order Info
See pages 142-143

Colors, Guides,
& Accessories
See pages 152-157

Study Carrel Series – Study Carrel



Units of 1, 2 or 4; Close enough for accurate supervision, yet separate enough to ensure individual achievement.

A virtually disturb-proof, compact configuration of sound-absorbing partitions between each desk.

16-gauge steel on a heavy-duty frame features strong connective nuts and bolts. Height adjustable.

Secure testing environment, private study/reading area or distraction-free computer work module.

Study Carrel STYLES



SCV2A-2436 - **Single Study Carrel**
Shown with Adj. Ht Illustration V2 Frame



SCV2F-2460 - **Double Study Carrel**
Shown in Wild Cherry with Fix. Ht. Illustration V2 Frame



SCTL-3660 - **Quad Study Carrel**
Shown in custom laminate Formica Ashen Ribbonwood 8839 & marker board laminate for work surface

Study Carrel Series – Study Carrel



SCWLA-3660 - Double Study Carrel
Shown with Dura Leg Frame

TOP

Surface: 1/8" Thick Fiberboard High-Pressure Laminate
Top Shelf: 10"D Top Shelf not available on Quad Study Carrels

Partitions: 3/4" Thick High Pressure Laminated On MDF
White Board Laminate color is not standard on Study Carrels.

T-LEG FRAME

Stretcher Bar: 16-Gauge Black Powder-Coated Rectangular Tube 1 1/8"W x 2 1/8"D

Upper Legs: 16-Gauge Black Powder-Coated 1 1/8"W x 2 1/8"D

Insert Legs: 16-Gauge Chrome-Plated Rectangular Tubing 1"W x 2"D

Glides: Screw-In Style, Nylon Base Glides

T-Leg Frame not available with a Light Gray frame finish.

DURA FRAME

Fully Welded, Unitized Frame: 2" x 1" Rectangular 16-Gauge Steel Frame welded to 1 1/8" Round 16-Gauge Steel Legs

Upper Legs: Available in Black or Tungsten Color

Insert Legs: Chrome-Plated 2" Round 16-Gauge Steel

Height Adjustable: Legs Adjust In 1" Increments

Height Options: Available In Four Height Variations

Casters/Glides: Compatible with Ht. Adj. Glides (Standard) or Casters (Optional)

Note: Casters add 2-3" to the overall height.

ILLUSTRATION V2 FRAME

Welded Connection: 1" Steel Tube, 12-Gauge Steel, welded to 1/4" Diameter 18 Gauge Steel Stretcher Bar

Wire Management: Available on Computer Table

Fix. Ht. Illustration V2 Table

Legs: Two 1 1/2" Diameter Tubes 16-Gauge Steel

Adj. Ht. Illustration V2 Table

Upper Legs: Two 1 1/2" Diameter Tubes 16-Gauge Steel

Insert Legs: Two 1 1/8" Diameter; 16-Gauge Steel Chrome Legs with Two Self-Locking Screws

Height Adjustable: Legs Adjust In 1" Increments

HIGH PRESSURE LAMINATE EDGE FINISH



PVC 3mm
Standard



Stable T-Leg



Easy Assembly with Dowels



Top Shelf Available

Optional Items: Grommets

Size & Order Info
See pages 142-143

Colors, Guides,
& Accessories
See pages 152-157

STAX Bookcase – Single and Double-Sided Bookcase



Ht."	W x D"	Shelves Per Side	Model
Single Bookcases			
36"	36 x 12"	1 Adj., 1 Fix. Bottom	BC-3636
48	36 x 12	2 Adj., 1 Fix. Bottom	BC-3648
60	36 x 12	2 Adj., 1 Fix. Center; 1 Fix. Bottom	BC-3660
72	36 x 12	3 Adj., 1 Fix. Center; 1 Fix. Bottom	BC-3672
84	36 x 12	4 Adj., 1 Fix. Center; 1 Fix. Bottom	BC-3684
Double Bookcases			
36"	36 x 24"	1 Adj., 1 Fix. Bottom	BCD-3636
48	36 x 24	2 Adj., 1 Fix. Bottom	BCD-3648
60	36 x 24	2 Adj., 1 Fix. Center; 1 Fix. Bottom	BCD-3660
72	36 x 24	3 Adj., 1 Fix. Center; 1 Fix. Bottom	BCD-3672
84	36 x 24	4 Adj., 1 Fix. Center; 1 Fix. Bottom	BCD-3684
Double Mobile Bookcases			
36"	36 x 24"	1 Adj., 1 Fix. Bottom	BCDM-3636
48	36 x 24	2 Adj., 1 Fix. Bottom	BCDM-3648

White Board laminate color is not standard on Bookcases.

STAX Curved Bookcase – Single and Double-Sided Bookcase



Ht."	W x D"	Shelves Per Side	Model
Single Bookcases			
36"	60 x 12"	4 Adj., 2 Fix. Bottom	BCURM-6036
42	60 x 12	4 Adj., 2 Fix. Bottom	BCURM-6042
48	60 x 12	4 Adj., 2 Fix. Bottom	BCURM-6048
Double Bookcases			
36"	60 x 24"	4 Adj., 2 Fix. Bottom	BCURDM-6036
42	60 x 24	4 Adj., 2 Fix. Bottom	BCURDM-6042
48	60 x 24	4 Adj., 2 Fix. Bottom	BCURDM-6048

White Board Laminate color is not standard on Bookcases.

Study Carrel Series – Study Carrel



W x D"	T-Leg Frame	Dura Frame		Illustration V2 Frame	
	22½-32½"H	Adj. 23-32" H	Fix. 29½" H	Adj. 27½-31½" H	Fix. 29" H
Single Study Carrel					
36 x 24"	SCTL-2436	SCWLA-2436	SCWLF-2436	SCV2A-2436	SCV2F-2436
Double Study Carrel					
60 x 24"	SCTL-2460	SCWLA-2460	SCWLF-2460	SCV2A-2460	SCV2F-2460
Quad Study Carrel					
60 x 36"	SCTL-3660	SCWLA-3660	SCWLF-3660	SCV2A-3660	SCV2F-3660

Optional Items: Grommets

T-Leg Frame not available with a Light Gray frame finish.
 White Board Laminate color is not standard on Study Carrels.
 Top Shelf: 10"D Top Shelf not available on Quad Study Carrels

Edge Finish & Color Options

<p>STAX Bookcase and STAX Curved Bookcase</p> <p>All standard laminate Bookcases have matching PVC 3mm Edge Banding, except Gray Nebula, which comes standard with Black Edge Banding. Either Black or Gray can be requested.</p>	<p>Study Carrel</p> <p>PVC 3mm edge banding; standard Black.</p>
--	---

See page 154 for more details.

Note the color needed at the time of ordering • All heights listed are within ¼" variants.

Boost Series – Café Tables



Table Ht."	W x D"	Model
Round Café Tables		
18"	30"	CFT-30R
18	36	CFT-36R
18	42	CFT-42R
30	30	CF-30R
30	36	CF-36R
30	42	CF-42R
36	30	CFJ-30R
36	36	CFJ-36R
36	42	CFJ-42R
42	30	CFSH-30R
42	36	CFSH-36R
42	42	CFSH-42R
Square Café Tables		
18"	30 x 30"	CFT-3030SQ
18	36 x 36	CFT-3636SQ
30	30 x 30	CF-3030SQ
30	36 x 36	CF-3636SQ
36	30 x 30	CFJ-3030SQ
36	36 x 36	CFJ-3636SQ
42	30 x 30	CFSH-3030SQ
42	36 x 36	CFSH-3636SQ
Oval Double Base Café Tables		
30"	36 x 60"	CF-3660OV
30	36 x 72	CF-3672OV
36	36 x 60	CFJ-3660OV
36	36 x 72	CFJ-3672OV
42	36 x 60	CFSH-3660OV
42	36 x 72	CFSH-3672OV

Optional Items: Power Port

Boost Series – Quad Café Tables



Table Ht."	W x D"	Model
Round Quad Café Tables*		
30"	30"	QCF-30R
30	36	QCF-36R
30	42	QCF-42R
36	30	QCFJ-30R
36	36	QCFJ-36R
36	42	QCFJ-42R
42	30	QCFSH-30R
42	36	QCFSH-36R
42	42	QCFSH-42R
Square Quad Café Tables*		
30"	30 x 30"	QCF-3030SQ
30	36 x 36	QCF-3636SQ
30	42 x 42	QCF-4242SQ
36	30 x 30	QCFJ-3030SQ
36	36 x 36	QCFJ-3636SQ
36	42 x 42	QCFJ-4242SQ
42	30 x 30	QCFSH-3030SQ
42	36 x 36	QCFSH-3636SQ
42	42 x 42	QCFSH-4242SQ
Squircle Quad Café Tables*		
30"	36 x 36"	QCF-3636SQCL
36	42 x 42	QCFJ-4242SQCL
42	36 x 36	QCFSH-3636SQCL
Oval Quad Café Tables*		
30"	36 x 60"	QCF-3660OV
30	36 x 72	QCF-3672OV
36	36 x 60	QCFJ-3660OV
36	36 x 72	QCFJ-3672OV
42	36 x 60	QCFSH-3660OV
42	36 x 72	QCFSH-3672OV

Optional Items: Power Port

*Quad legs are only available in gray.

Boost Series – Café Stools



Seat Ht."	W x D"	Frame Color		
		Chrome	Gray Powder Coating	Black Powder Coating
Inspiration Café Stools				
24"	19½ x 22½"	7424	—	—
30	19½ x 22½"	7430	—	—
Zed Café Stools				
24"	19½ x 22½"	Z424	Z424G	Z424B
30	19½ x 22½"	Z430	Z430G	Z430B

Optional Items: Glide Caps (Felt, Rubber and Steel).

Edge Finish & Color Options

Boost Series - Cafe Tables

Standard: Hydraulically inserted T-Mold edge banding in Black or Gray.

Optional: Colored T-Mold edge.

Optional X-Strong Finish and PVC 3mm Finish: Are available in all standard and colored edge options.

See page 154 for more details.

Note the color needed at the time of ordering • All heights listed are within ¾" variants.

Mobile Easel & Knapsack Rack



The Mobile Knapsack Rack comes with 12 rubber-top double hooks per unit; individual name plates.

Mobile, strong and convenient! Bottom rack for boots. 4 casters total; 2 locking casters.

The mobile easel's super strong frame and durable wipe-off board will last for years to come.

Four sure-locking casters take your easel anywhere, securely and easily.

Mobile Easel & Knapsack Rack STYLES



7700 - Mobile Easel
(Accessories shown not included)



4670 - Mobile Knapsack Rack
(Accessories shown not included)

Mobile Easel & Knapsack Rack



7700 - Mobile Easel & 4670 - Mobile Knapsack Rack
(Accessories shown not included)

MOBILE EASEL

Dry-Erase Board: Porcelain Magnetic Marker Board Encased In Metal Frame 30" x 30"

Unitized Frame: 1" Square Steel Tubing, Powder-Coated

Tray Supports: Steel Frame 23¼"W x 28"D

Tray: 4 - Rectangular Plastic Holding Removable Trays 9" x 12" x 3"

Casters: 4 - Standard 2" Heavy-Duty Locking Casters

MOBILE KNAPSACK RACK

Size: 38"W x 41½"H x 24"D

Hooks: 6 rubber tip double hooks per side, 12 per unit. A name plate by each hook.

Bottom Rack: comes standard with bottom rack for boots. 16 gauge steel frame and 18 gauge steel crossbar.

Finish: Gray textured powder coated finish.

Casters/Glides: Standard with 4 Glides or Casters (2 that lock).



Mobile Easel
Storage Compartments, Unitized Frame
& Locking Casters

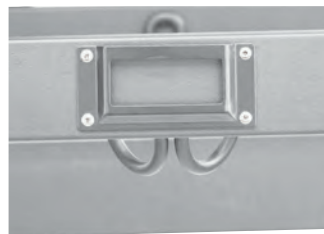

Mobile Knapsack Rack
Name Plate



Mobile Knapsack Rack
Rubber Tip Double Hook

Power Post & Power Port



Connecting the class to technology has never been so easy.

Power options are ideal for media centers, common areas & libraries.

The Power Port can be installed in all tables and café tables.

The mobile Power Post can be placed in the middle of pods or tables.

Power Post & Power Port STYLES



T-PWR-POST
Power Post



99TT-PWRS-2
Power Port



99TT-PWRS-USB
Power Port



99TT-PWRD-RND-USB
Power Port

Power Post & Power Port



T-PWR-POST - Power Post

POWER POST TOP

Frame: 10-Gauge Steel. Black Or Gray Textured Powder-Coated Finish.

Outlets: 8 UL Listed Power Receptacles; 2 Outlets & 2 USB Ports Per Side.

Wire Management: Two Wrap-Around Hooks

Cord: Outlets Are Linked To One Heavy-Duty 133" Cord

Base: 4-Gauge Steel 12" X 12"

Casters: Four 2" Locking Casters

POWER PORTS*

Pop-Up Mechanism: Pop-Up Mechanism Protect By Steel Housing

Power Receptacles

99TT-PWRS-USB: Two USB Receptacles & One UL Listed Power Receptacle

99TT-PWRS-2: Two UL Listed Power Receptacles

*Power Ports must be manufacturer installed.

Connect: Add a power port to any table or teachers desk and charge any electronic device.



Power Port

(Shown on CL-2448 - Computer Table)



Power Port

(Shown on CFSH-3672OV - Standing Ht. Oval Café Table)



Power Port

(Shown on 8138-LAM - 30" Round Mod® with Laminate Top)

Energize your students with a simple power solution.

Shown In: CL-2448 in custom Nevamar #WM0047 Tabletop



Mobile Easel

Ht."	W x D"	Model
54"	32 x 25"	7700



Power Post Top

Ht."	W x D"	Model
38"	12 x 12"	T-PWR-POST



Mobile Knapsack Rack

Ht."	W x D"	Model
41½"	38 x 24"	4670



Power Ports

W x D"	Model
5 x 5"	99TT-PWRS-2
5 x 5"	99TT-PWRS-USB
3.5" Dia.	99TT-PWRS-RND-USB-B

Note: Power Ports must be manufacturer installed.



Designers PORTAL



Stay organized by categorizing school and districts into **visual project boards**.



Chat with **Academia's educational specialists**.

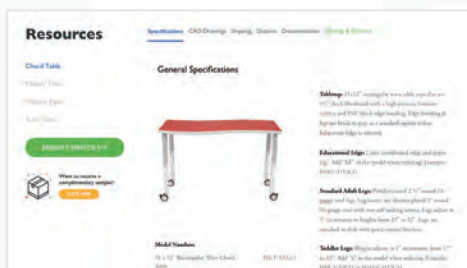

Download, email or save quotes including **specification sheets, cut sheets, product images and CAD drawings**.



Create **budgetary pricing** according to National KPN contract.

Request a Complimentary
SWATCH BOX
 & Product Samples within 48 hours

Desk, Seat, Table, &
 The Mod Series®
 Swatches Available



"Squirle", "The Mod Series" & "Mod" are registered trademarks of Academia Furniture Industries.

www.academiafurniture.com/insights/designers-portal



INSTALL SHOWCASE



OUR WORLD NEIGHBORHOOD CHARTER SCHOOL - HOWARD BEACH, NY



OUR WORLD NEIGHBORHOOD CHARTER SCHOOL - HOWARD BEACH, NY



LINCOLN COMMUNITY HIGH SCHOOL - LINCOLN, IL



FRANKLIN ELEMENTARY SCHOOL - BOONE, IA



HINDMAN ELEMENTARY SCHOOL - HINDMAN, KY





IMMACULATA HIGH SCHOOL - SOMMERVILLE, NJ



THE POTOMAC SCHOOL - MCLEAN, VA



EDWARD H. BRYAN SCHOOL - CRESSKILL, NJ



VANGUARD ACADEMY REMBRANDT ELEMENTARY EARLY CHILDHOOD CENTER - PHARR, TX



CHESAPEAKE SCIENCE POINT CHARTER ELEMENTARY SCHOOL - HANOVER, MD



KIRKWOOD HIGH SCHOOL - CLARKSVILLE, TN



Seating, Desk & Table – Caster

Seating Caster Guide

Series	Soft Caster	Hard Caster
Chairs: I28C, I26C, Z28C, Z26C, 716C, 718C, 518C	 9SF28W-SC	 STANDARD 9SF28W-C
Computer Chair	 9HF58SC	 STANDARD 9HF58C
Computer Chair Braking Caster	—	 9HF58LC
Mod® Caster	—	 9MOD-CASTER

Desk & Table Caster Guide

Series	Soft Caster	Hard Caster
T-Leg Series C-Leg Series	—	 99TW60M
Demonstration Series: STEM Table* STEM Work Station	—	 99TW75- TOTAL LOCK
Synergy Desk Surge Desk Dura Table* Harmony Table Hercules Legs* Illustration V2 Series Petal Series	 99TW75-IL-SOFT	 99TW75-IL-HARD
Nate Double Pedestal Desk	 99NT-LC	—

*Wheelbarrow option available for all adjustable height tables. When ordering wheelbarrow option, order 1 set of casters per 2 tables.

Caster Floor Finish Guide

Floor Type	Soft Caster	Hard Caster
Carpet		•
Hardwood	•	
Polished Concrete	•	
Rubber		•
Tile	•	
Vct(Vinyl)		•

Important Note: Please note that casters add 2-3" to the overall height of the item they are being used with. Example: a desk that is 29" without casters, will be 32" with casters.

Hard casters for soft flooring. Soft casters for hard flooring.

Disclaimer: The following information is offered based on our extensive research and testing. This information is recommended as a guide. It is suggested that the customer does their own research to insure that the glide or caster chosen is the proper selection for their flooring.

Glide Guide

Series	Glide	Nylon	Felt	Rubber	Steel	Extras
Classic Chair Inspiration Chair Hard-Plastic Chair Zed Chair Classic Combos ¹ Standard Desk Activity Tables Café Stools	 Glide shown with Felt Cap	 STANDARD	 9GL-FLT-CVR	 9GL-TPR-CVR	 9GL-STL-CVR	 Felt Snap Cap 9GL-FELT-SNAP
Illustration V2 Desks and Table		 STANDARD	—	 Set of Four 9GL-IL-TPR	—	—
C-Leg Series T-Leg Series		 STANDARD	—	 Set of Four 9GL-TPR	—	—
Sled Base Combos	—	—	—	 Set of Four 9GL-TPR	—	—
Cantilever Chair	 Front Glide Back Glide Color-Coordinated Glides shown with Felt Insert	 Front Inserts: 9GL-IS88-FR-I-NYL Back Inserts: 9GL-IS88-BK-I-NYL	 Front Inserts: 9GL-IS88-FR-I-FLT Back Inserts: 9GL-IS88-BK-I-FLT	 Front Inserts: 9GL-IS88-FR-I-RUB Back Inserts: 9GL-IS88-BK-I-RUB	 Front Inserts: 9GL-IS88-FR-I-STL Back Inserts: 9GL-IS88-BK-I-STL	 Glide Remover for Cantilevered The glide housing and glide inserts have been engineered for easy replacement of worn out inserts. The inserts are designed to mold to flooring and are tamper proof.
Innovation Desk	 Glide shown with Felt Insert	 9GL-I-B-NYL 9GL-I-G-NYL	 9GL-I-B-FLT 9GL-I-G-FLT	 9GL-I-B-RUB 9GL-I-G-RUB	 9GL-I-B-STL 9GL-I-G-STL	—
Computer Chair Series ²		 Set of Five 9HFSG	 9GL-SG-U-FLT	 9GL-SG-U-TPR	 9GL-SG-U-STL	—

Glide Floor Finish Guide

Floor Type	Nylon	Felt	Rubber	Steel
Carpet	•			•
Hardwood		•		
Polished Concrete	•	•		•
Rubber	•		•	
Tile	•	•	•	
Vct(Vinyl)	•	•	•	

¹ Excluding Sled Base Combination Desks

² The options shown are only if stationary bell glides are requested. Standard, the chair ships with casters.

Disclaimer: The following information is offered based on our extensive research and testing. This information is recommended as a guide. It is suggested that the customer does their own research to insure that the glide or caster chosen is the proper selection for their flooring.

Woodstone & Hard Plastic



Woodstone Desktops offer a whole new level of durability, strength, convenience and value.

Woodstone is a mixture of wood fibers and melamine resin, with a laminate finish –baked at 308°F under high pressure.

Lighter: They are 10% lighter than a Hard Plastic Desktop

Affordable: Woodstone Desktops cost about 18% less than conventional hard plastic.

Reliable: Woodstone exceeds ANSI/BIFMA requirement on 5 rigorous tests!



Hard Plastic desktops are solid plastic manufactured with ground hardwood floor, color pigment and melamine plastic resins blended and compressed under heat and pressure to form a homogeneous top.

Classic & Timeless: An all time classic for schools everywhere.

Resilient: Solid Plastic desktops are resilient, heavy-duty and virtually maintenance free.



High-Pressure Laminate Edge Finishes



T-MOLD STANDARD

Hydraulically inserted PVC T-Mold edge banding 1/8" thick, bull-nose profile and smooth matte finish.



T-Mold*
(Shown in Aqua)



X-STRONG OPTIONAL

Sprayed on polyurea, a tough and waterproof textured Epoxy paint, bonded directly onto the table edge, finished with a high lacquer coating.



X-Strong*
(Shown in Black)



PVC 3MM OPTIONAL

3mm thick PVC material applied with heat activated durable adhesive, in a smooth flat matte finish.



PVC 3mm*
(Shown in Primary Green)

High-Pressure Laminate Edge Finishes	T-Mold Standard	X-Strong Optional	PVC 3mm Optional
Student Desk, Classroom Table and Café Table	•	•	•
Combo Desk	•		
Teacher Desk: Nate Stations/Desks and Petal Lazer			•
Teacher Desk: Vantage and Kinect	•		
Study Carrel			•

*Edge Finishes are available in standard Black and Light Gray, and in all Educational Edge colors

Colors shown in this printed catalog may vary slightly from actual product due to aging, lighting, and printing process. For accurate color representations request a complimentary physical swatch.



Desktop Options



Rectangular

(Available in all colors)



Tablet-Arms - Standard & Jumbo Top

(Available in Gray Nebula, Light Gray, Beige, and Light Oak)



Arc-Shaped

(Available in Gray Nebula, Light Gray, Beige, Light Oak Cherry and Driftwood)

Woodstone Desktop Colors



Gray Nebula



Light Gray

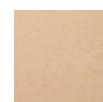

Beige



Fusion Maple



Light Oak



Cherry



Driftwood



Desktop Options



Rectangular

(Available in all colors)



Tablet-Arms - Standard & Jumbo Top

(Available in Gray Nebula, Light Gray, Beige, and Bannister Oak.)



Innovation

(Available in Gray Nebula, Fusion Maple, Bannister Oak, and Wild Cherry)



Petal Series

(Available in Gray Nebula, Light Gray, Fusion Maple, Bannister Oak, and Wild Cherry)

Hard-Plastic Desktop Colors



Gray Nebula



Light Gray

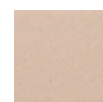

Beige



Fusion Maple



Bannister Oak



Wild Cherry



Stimulate and enhance the way students learn by adding color to the classroom. Create an encouraging environment by color coordinating the book boxes, edges and legs to the overall classroom. Look for Educational Edge on the individual item pages to see what can be customized on each of our models.

Educational Edge/Leg Colors



Primary Red



Burgundy



Purple



Primary Blue



Navy



Ocean Blue



Aqua



Primary Green



Lime Green



Tangerine



Sunshine Yellow



Graphite

Standard Options

High-Pressure Laminate Colors

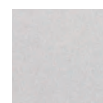

Gray Nebula



Fusion Maple



Bannister Oak



Enrich



Wild Cherry



White Board

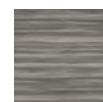

Driftwood



Sky Rise

White Board: Warranty and proper care information can be found on our price list or by contacting your local dealer. White Markerboard is NOT standard for Nate Teacher Desks, Study Carrels, Bookcases, STEM Workstation Cabinet and Tote Bin Cabinet.

Standard Frame Finishes

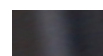

Black



Tungsten Gray

Standard Edge Banding & Legs*



Black



Light Gray

*Only for Tables and Student Desks

Colors shown in this printed catalog may vary slightly from actual product due to aging, lighting, and printing process. For accurate color representations request a complimentary physical swatch.

Seat Options

Seat Shapes



Adj. Ht. Squircle® Stool



Fix. Ht. Squircle® Stool

Squircle® Stool Colors



Zed, Inspiration & Classic Chair Seat Colors



Zed Seats

Inspiration Seats

Classic Seats



Hard-Plastic Seats

Round Hard-Plastic Seats*

Hard-Plastic & Round Hard-Plastic Chair Seat Colors

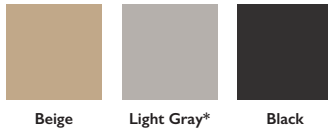

*Note: Light Gray is not available in Round Hard-Plastic Seats

Seating Frame Options

Chair Frame Finish



Chrome

Gray (G) Powder Coating**

Black (B) Powder Coating**

**Powder Coating: Only available for Zed Chair. Not available with Bookbasket (WBB), Computer Chair and Drafting Stool.

Tote Bins



9CRTWD-SLIM TRAY-M Matte Colored Tray

Primary Colors - Standard



Pastel Colors - Standard

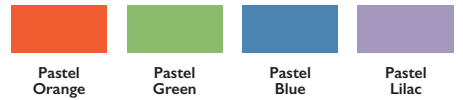

Bold Colors (10 Week Lead Time)



Crystal Colors (Upcharge)

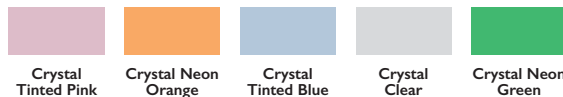

9CRTWD-SlimC-Run I Runner & Clear or Crystal Tray as a set (for desk or table)

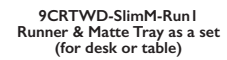

9CRTWD-SlimM-Run I Runner & Matte Tray as a set (for desk or table)

Colors shown in this printed catalog may vary slightly from actual product due to aging, lighting, and printing process. For accurate color representations request a complimentary physical swatch.

Chairs

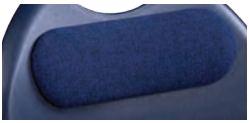

Pads (Must be manufacturer installed)

Computer & Seminar Table Accessories



Wire Management for V2 Illustration (99V2-MP36-72)



Wire Management End Cap for Illustration V2 Tables only (99IL-MP-CAP)

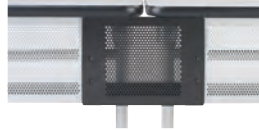

Connector Bridge for V2 Illustration (99IL-MP-Bridge)



Connector Bridge for C-Leg Series Only (99-MP-Bridge)



Standard Keyboard (Key)
20"W x 11"D



Standard Keyboard with Mouse Pad (KEY-F312) 20"W x 11"D
Mouse is 9" Round



T-Leg Wire Management (WM36-72)



Grommets (99GC)



Table Hook for All Except V2 Series (9TAB-HOOK)

Size Chart

Number of Computer Workstations Per Table

Table Width	1 CPU	2 CPUs	3 CPUs
36"	•		
48"	•	•	
60"	•	•	
72"	•	•	•

Desk Accessories

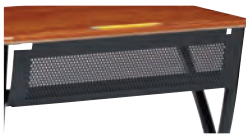

Illustration V2 Modesty Panel (9DF27-MP)



Pencil Drawer for Single & Double Pedestal (99NT-PENCIL)



Cup Holder (99-CUPHOLDER)



Innovation, Petal, and Surge Series Hooks (9TRI-Hook)



Illustration V2 Backpack Hooks (9DF27-BKHK)

Book Boxes



Innovation Mesh Book Box (9TRI-BKXB) 17"W x 12"D x 4"H //3.5WT



Innovation Wire Book Box (9TRI-WBR) 17"W x 14"D x 4"H //2.5 WT



Steel Book Box for T-Leg and Double Desks (99DDMBB-B) 18"W x 16"D x 5"H //5WT



Petal & Jr Petal Mesh Book Box (9DF1950-MBB) 17"W x 12"D x 4"H //3.5WT



Illustration V2 and Surge Mesh Book Box (9DF17-MBB) 17"W x 12"D x 4 1/2"H //4WT

Academia

FURNITURE INDUSTRIES

74 S. Passaic St. Wood-Ridge, NJ 07075
973-472-0100 • academiafurniture.com

