



INSPIRING FURNITURE SOLUTIONS FOR THE MODERN OFFICE



2024 CATALOG

COEdistributing.com
800 388 8202

MODERN

Elegance



MIRA



OfficeSource®
FURNITURE



TABLE OF CONTENTS

DESKS

Wood Veneer..... 4-13
Laminate..... 14-75
Laminate & Steel..... 28-29
Height Adjustable 76-81
Reception 82-94

SHIELDS

Fabric & Acrylic..... 95-96
Laminate & Acrylic 96
Brackets..... 97

PANELS

Partitions 98-101
Magnetic Dry-Erase Boards..... 102
Magnetic Mobile Glass Boards 103

TABLES

Laminate Training..... 104-111
Laminate Conference..... 112-114
Wood Veneer Conference..... 114
Multi-Purpose 115-126
Hospitality 127-130
Hospitality + Outdoor..... 131
Folding & Educational..... 132-133

SEATING

Reception + Guest..... 134-154

Educational + Folding..... 155
Stacking 156-163
Nesting..... 164-165
Stools 166-173
Mesh..... 174-194
Executive 195-209
Big & Tall + Guest 210-215
Seating Functions..... 216
Seating Accessories 217

STORAGE

Laminate Bookcases..... 218
Steel Bookcases..... 219
Heavy Duty Wire Racks..... 219
Laminate Lateral Files 220
Steel Lateral Files 220-221
Benching Cabinets..... 221
Laminate Storage Cabinets..... 222
Steel Storage Cabinets 223
Laminate Pedestals & Cubbies..... 224
Metal Pedestals 225
Metal Open Hanging Storage 225
Steel Vertical Files..... 226

ACCESSORIES + TECHNOLOGY

Modular Electric Systems 227
Monitor Arms..... 228
Task Lighting 229

Wire Management 229
Grommets 230
Power Inserts + Modules 231-232
Center Drawer..... 232
Keyboard Systems..... 232-233
CPU Holder 233
Chair Mats 234-237

SPECIAL ORDERS

Introduction 238
Leisure craft Outdoor Furniture 239
Indiana Furniture 240-241
Candex 242-246
Virco 246-249
Diversified Furniture..... 250-251
Screenflex..... 252-253
Mooreco..... 254-255
FireKing 256-257

INDEX

By Collection 258

SO = SPECIAL ORDER Special order items are indicated with **SO** before the model number. Note that lead times on special order items can vary greatly.
QS = QUICKSHIP Quickship items are indicated with **QS** before the model number. Please note that delivery time is approximately 1-3 weeks.

Prices subject to change. Contact us to verify current pricing.
Colors pictured in the catalog are representation only. If exact color match is necessary, please request finish or upholstery sample before placing your order.
This catalog and its contents are proprietary to COE Distributing. Copyright 2023/2024 by COE Distributing. All Rights Reserved. Printed in the U.S.A.





ROWLAND

Executive Typical ROWLAND1

Total List: \$15,378.00
Includes: CM720, CM682,
CM689 & CM450
Excludes Accessories

A 72"W Executive Desk CM720

72"W x 35"D x 30"H
List: \$5,063.00

B Executive Hutch CM682

70"W x 14"D x 42"H
List: \$3,226.00

Use with CM689

C Knee Space Credenza CM689

72"W x 24"D x 30"H
List: \$4,518.00

D 2 Drawer Lateral File CM450

36"W x 23"D x 30"H
List: \$2,571.00



U Shape Typical ROWLAND2

Total List: \$13,904.00
Includes: CM684R, CM684B,
CM684RC & CM682
Excludes Accessories

E U Shape Desk w/Right Credenza

CM684R (Desk)

CM684B (Bridge)

CM684RC (Credenza)

Desk: 72"W x 30"D x 30"H

Bridge: 50"W x 24"D x 30"H

Credenza: 72"W x 24"D x 30"H

List: \$4,580.00 (Desk)

List: \$2,031.00 (Bridge)

List: \$4,067.00 (Credenza)



MH Mahogany

Some items in this collection come ready-to-assemble.



**Conference Typical
ROWLAND4**
Total List: \$10,796.00
Includes: CM2048 (2)
& CM3072 (2)
Excludes Accessories

ROWLAND

**F Open Bookcase
CM3072**
30"W x 14"D x 72"H
List: \$2,323.00

**G 48"W Conference Table
CM2048**
48"W x 48"D x 30"H
List: \$3,075.00

*Multiple tables can be put together
to create your desired length.*

**H L Shape Desk w/Right Return
CM684R (Desk)
CM684RR (Return)**
Desk: 72"W x 30"D x 30"H
Return: 50"W x 24"D x 30"H
List: \$4,580.00 (Desk)
List: \$3,305.00 (Return)

*Note: Must purchase both desk & return.
Return is not reversible.*

**L Shape Desk w/Left Return
CM684L (Desk)
CM684LR (Return)**
Desk: 72"W x 30"D x 30"H
Return: 50"W x 24"D x 30"H
List: \$4,580.00 (Desk)
List: \$3,305.00 (Return)

*Note: Must purchase both desk & return.
Return is not reversible.*



**L Shape Typical
ROWLAND3**
Total List: \$11,111.00
Includes: CM684R,
CM684RR & CM682
Excludes Accessories

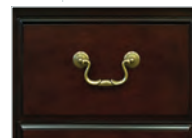

UNIQUE FINISH PULLS

*Mahogany wood veneer with antique
brass finished traditional pulls*



MH Mahogany

Some items in this collection come
ready-to-assemble.



MARKLE

Executive Typical MARKLE1
 Total List: \$18,180.00
 Includes: FL680, FL682, FL689, FL450 & FL3072
 Excludes Accessories

- A 68"W Executive Desk FL680**
68¼"W x 32"D x 30"H
List: \$5,580.00
- B Executive Hutch FL682**
69¼"W x 13"D x 42"H
List: \$2,955.00
- C Knee Space Credenza FL689**
68¼"W x 24"D x 30"H
List: \$4,735.00
- D 2 Drawer Lateral File FL450**
32"W x 21"D x 30"H
List: \$2,645.00
- E Open Bookcase FL3072**
30"W x 13½"D x 72"H
List: \$2,265.00

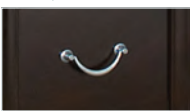

UNIQUE FINISH PULLS

Rich espresso wood veneer with satin nickel finished traditional pulls

ADDITIONAL PRODUCTS



Bookcase w/Doors QSFL3072D
 30"W x 13½"D x 72"H
 List: \$2,650.00



RE Rich Espresso

QS = QUICKSHIP

Items in this collection come fully assembled.



FL680 Shown - User Side
 Two Locking Legal/File Drawers



MARKLE

NEW! Executive Typical
QSMARKLE3
 Total List: \$19,470.00
 101"W x 135"D x 72"H
 Includes: FL684R, FL684RR, FL450,
 FL682, FL3072 & QSMFL3072D
 Excludes Accessories

FEATURES

- Modern office that blends traditional design elements with contemporary influences
- Crown molding with picture frame detailing
- Satin nickel hardware complements the rich, espresso hardwood veneer finish



F L Shape Desk w/Right Return
FL684R (Desk)
FL684RR (Return)
 Desk: 68¼"W x 28"D x 30"H
 Return: 47¼"W x 22"D x 30"H
 List: \$5,152.00 (Desk)
 List: \$3,803.00 (Return)

*Note: Must purchase both desk & return.
 Return is not reversible.*

G L Shape Desk w/Left Return
FL684L (Desk)
FL684LR (Return)
 Desk: 68¼"W x 28"D x 30"H
 Return: 47¼"W x 22"D x 30"H
 List: \$5,152.00 (Desk)
 List: \$3,803.00 (Return)

*Note: Must purchase both desk & return.
 Return is not reversible.*

PRODUCT FEATURES



Crown molding edges on the bottom of casegoods



Satin nickel hardware set on picture frame detailing for drawers



L Shape Desk - Left
(Pictured)



RE Rich Espresso

QS = QUICKSHIP

Items in this collection come fully assembled.



Executive Typical
QSREFINED2W
 Total List: \$26,752.00
 Includes: IMHF680W,
 IMHF682W, IMHF689W,
 IMHF450W & **QS** IMHF4078DW
 Excludes Accessories

REFINED
 Vintage Linen Finish

- A 70"W Executive Desk**
IMHF680W
 70"W x 30"D x 31"H
 List: \$7,099.00
- B Executive Hutch**
IMHF682W
 71"W x 14"D x 49"H
 List: \$5,397.00
- C Knee Space Credenza**
IMHF689W
 70"W x 21"D x 31"H
 List: \$5,671.00
- D 2 Drawer Lateral File**
IMHF450W
 36"W x 21"D x 31"H
 List: \$3,403.00
- E Bookcase w/Doors**
QSIMHF4078DW
 40"W x 14"D x 78"H
 List: \$5,182.00
Open Bookcase
QSIMHF4078W
 40"W x 14"D x 78"H
 List: \$4,674.00

ADDITIONAL PRODUCTS



60"W Writing Desk
IMHF384W
 60"W x 28"D x 31"H
 List: \$3,598.00



L Shape Desk w/Right Return
IMHF684RW (Desk)
IMHF684RRW (Return)
 Desk: 69½"W x 30"D x 31"H
 Return: 47½"W x 21"D x 31"H
 List: \$6,473.00 (Desk)
 List: \$4,732.00 (Return)

*Note: Must purchase both desk & return.
 Return is **not** reversible.*



L Shape Open Desk w/Right Return
IMHF386RW (Desk)
IMHF386RRW (Return)
 Desk: 60"W x 28"D x 31"H
 Return: 47½"W x 21"D x 31"H
 List: \$3,403.00 (Desk)
 List: \$2,229.00 (Return)

*Note: Must purchase both desk & return.
 Return is **not** reversible.*



VL Vintage Linen
 w/Dry Gray Tops

QS = QUICKSHIP

Items in this collection come fully assembled.



**Executive Typical
REFINED1**
Total List: \$21,570.00
Includes: IMHF680, IMHF682,
IMHF689 & IMHF450
Excludes Accessories

REFINED
Vintage Black Finish

**A 70"W Executive Desk
IMHF680**
70"W x 30"D x 31"H
List: \$7,099.00

**B Executive Hutch
IMHF682**
71"W x 14"D x 49"H
List: \$5,397.00

**C Knee Space Credenza
IMHF689**
70"W x 21"D x 31"H
List: \$5,671.00

**D 2 Drawer Lateral File
IMHF450**
36"W x 21"D x 31"H
List: \$3,403.00

ADDITIONAL PRODUCTS



**60"W Writing Desk
QSIMHF384**
60"W x 28"D x 31"H
List: \$3,598.00

**60"W Sit/Stand Desk
QSIMHF384T (Top Only)**
60"W x 28"D x 6"H
List: \$2,972.00

**Bookcase w/Doors
QSIMHF4078D**
40"W x 14"D x 78"H
List: \$5,182.00

**Open Bookcase
QSIMHF4078**
40"W x 14"D x 78"H
List: \$4,674.00



**L Shape Desk w/Right Return
IMHF684R (Desk)
IMHF684RR (Return)**
Desk: 69½"W x 30"D x 31"H
Return: 47½"W x 21"D x 31"H
List: \$6,473.00 (Desk)
List: \$4,732.00 (Return)

*Note: Must purchase both desk & return.
Return is not reversible.*



**L Shape Open Desk w/Right Return
QSIMHF386R (Desk)
QSIMHF386RR (Return)**
Desk: 60"W x 28"D x 31"H
Return: 47½"W x 21"D x 31"H
List: \$3,403.00 (Desk)
List: \$2,229.00 (Return)

*Note: Must purchase both desk & return.
Return is not reversible.*

See Pages 77-78 for
available 48" HAT Units

QS = QUICKSHIP

Items in this collection come fully assembled.



BK Vintage Black
w/Wood Plank Tops



**Executive Typical
MONROE1**

Total List: \$22,210.00
Includes: IMCA680, IMC682,
IMCA689, IMCA450 & IMCA4076
Excludes Accessories

MONROE

- A 68"W Executive Desk
IMCA680**
68"W x 28"D x 30"H
List: \$5,975.00
- B Executive Hutch
IMCA682**
70"W x 15"D x 46"H
List: \$4,475.00
- C Knee Space Credenza
IMCA689**
68"W x 19"D x 30"H
List: \$5,145.00
- D 2 Drawer Lateral File
IMCA450**
36"W x 21"D x 31"H
List: \$3,045.00
- E Open Bookcase
IMCA4076**
40"W x 15"D x 76"H
List: \$3,570.00

ADDITIONAL PRODUCTS



**60"W Sit/Stand Desk
QSIMCA384T (Top Only)**

60"W x 27"D x 6"H
List: \$2,845.00

See Pages 77-78 for
available 48" HAT Units

**54"W Writing Desk
QSIMCA384**

54"W x 27"D x 30"H
List: \$3,050.00

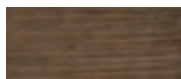

GR Weathered
Dove Gray

QS = QUICKSHIP
Items in this collection come fully assembled.



**L Shape Desk w/Right Return
IMCA684R (Desk)**

IMCA684RR (Return)
Desk: 68"W x 28"D x 30"H
Return: 48"W x 24"D x 30"H
List: \$4,510.00 (Desk)
List: \$3,265.00 (Return)

Note: Must purchase both desk & return.
Return is not reversible.



**L Shape Open Desk w/Right Return
QSIMCA386R (Desk)**

QSIMCA386RR (Return)
Desk: 60"W x 27"D x 30"H
Return: 48"W x 21"D x 30"H
List: \$2,600.00 (Desk)
List: \$2,245.00 (Return)

Note: Must purchase both desk & return.
Return is not reversible.



STOCKTON

Executive Typical
STOCKTON1
 Total List: \$18,863.00
 Includes: IMKN680, IMKN682,
 IMKN689 & **Q** IMKN3678D
 Excludes Seating & Accessories

- | | | | |
|---|---|---|---|
| <p>A 66"W Executive Desk
 IMKN680
 66"W x 28"D x 30"H
 List: \$5,472.00</p> | <p>B Executive Hutch
 IMKN682
 66"W x 14"D x 48"H
 List: \$4,448.00</p> | <p>C Knee Space Credenza
 IMKN689
 66"W x 22"D x 30"H
 List: \$4,927.00</p> | <p>D Bookcase w/Doors
 QSIMKN3678D
 36"W x 14"D x 78"H
 List: \$4,016.00</p> <p>Open Bookcase
 IMKN3678
 36"W x 14"D x 78"H
 List: \$3,820.00</p> |
|---|---|---|---|

UNIQUE DETAILS

*Raised criss-cross inlays
 gives this collection a
 stately and refined look*

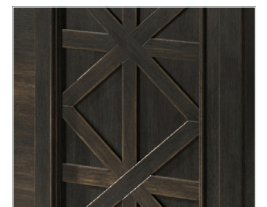

ADDITIONAL PRODUCTS

- | | |
|--|---|
| <p>60"W Writing Desk
 QSIMKN384
 60"W x 28"D x 30"H
 List: \$2,734.00</p> | <p>2 Drawer Lateral File
 IMKN450
 36"W x 22"D x 30"H
 List: \$3,154.00</p> |
| <p>60"W Sit/Stand Desk
 QSIMKN384T (Top Only)
 60"W x 28"D x 6"H
 List: \$2,113.00</p> | <p>4 Door Console
 QSIMKN370
 70"W x 18"D x 32"H
 List: \$4,037.00</p> |

See Pages 77-78 for
 available 48" HAT Units

Q = QUICKSHIP

Items in this collection come fully assembled. **DC** Dark Chocolate



- L Shape Desk w/Right Return**
IMKN684R (Desk)
IMKN684RR (Return)
 Desk: 66"W x 28"D x 30"H
 Return: 44"W x 21"D x 30"H
 List: \$5,141.00 (Desk)
 List: \$3,278.00 (Return)

*Note: Must purchase both desk & return.
 Return is not reversible.*



Executive Typical

QSPALMER1

Total List: \$28,033.00

Includes: QSIMTE680, QSIMTE450,

QSTE4094 (3) & QSIMTE402

Excludes Accessories

PALMER

A 68"W Executive Desk

QSIMTE680

68"W x 30"D x 30"H

List: \$6,032.00

B 2 Drawer Lateral File

QSIMTE450

36"W x 22"D x 30"H

List: \$3,276.00

C Open Bookcase

QSTE4094

40"W x 15"D x 94"H

List: \$5,642.00

D Metal Ladder

QSIMTE402

14½"W x 3"D x 90"H

List: \$1,799.00

Use with TE4094

ADDITIONAL PRODUCTS



72"W Writing Desk

QSIMTE384

72"W x 30"D x 30"H

List: \$3,305.00



Buffet Credenza

QSIMTE689

68"W x 18"D x 30"H

List: \$4,996.00



User Side
Two-Tone Colors



QS = QUICKSHIP

Items in this collection come fully assembled.

AE Aged Ebony
w/Honey Wood



Executive Typical WESTWOOD1
 Total List: \$26,330.00
 Includes: IMSA680, IMSA682, IMSA689 & IMSA450
 Excludes Accessories

WESTWOOD

**A 68"W Executive Desk
 IMSA680**
 68"W x 28"D x 30"H
 List: \$8,430.00

**B Executive Hutch
 IMSA682**
 68"W x 14"D x 48"H
 List: \$6,510.00

**C Knee Space Credenza
 IMSA689**
 68"W x 24"D x 30"H
 List: \$7,470.00

**D 2 Drawer Lateral File
 IMSA450**
 36"W x 22"D x 30"H
 List: \$3,920.00

ADDITIONAL PRODUCTS



**Left Tall Bookcase
 QSIMSA4094L**
 40"W x 14"D x 94"H
 List: \$7,605.00

**Center Tall Bookcase
 QSIMSA4094C**
 40"W x 14"D x 94"H
 List: \$7,605.00

**Right Tall Bookcase
 QSIMSA4094R**
 40"W x 14"D x 94"H
 List: \$7,605.00



**Wood Ladder
 QSIMSA402**
 14¾"W x 3"D x 75"H
 List: \$961.00
Use with IMSA4094

**Open Bookcase
 IMSA3678**
 36"W x 14"D x 78"H
 List: \$4,955.00

**54"W Writing Desk
 QSIMSA384**
 54"W x 28"D x 30"H
 List: \$3,390.00

**Bookcase w/Doors
 QSIMSA3678D**
 36"W x 14"D x 78"H
 List: \$6,154.00



**L Shape Desk w/Right Return
 QSIMSA684R (Desk)
 QSIMSA684RR (Return)**
 Desk: 68"W x 28"D x 30"H
 Return: 44"W x 22"D x 30"H
 List: \$7,395.00 (Desk)
 List: \$4,535.00 (Return)

*Note: Must purchase both desk & return.
 Return is not reversible.*



DR Dark Roast w/Wood Tops

QS = QUICKSHIP

Items in this collection come fully assembled.



ARTISAN
Natural Finish

Executive Typical
ARTISAN1

Total List: \$12,093.00
Includes: MNM680, MNM682,
MNM689 & MNM3678D
Excludes Accessories

A 66"W Executive Desk
MNM680
66"W x 30"D x 31"H
List: \$3,656.00

B Executive Hutch
MNM682
66"W x 12"D x 47½"H
List: \$2,354.00

C Knee Space Credenza
MNM689
66"W x 21"D x 31"H
List: \$3,287.00

D Bookcase w/Doors
MNM3678D
36"W x 12"D x 78"H
List: \$2,796.00

Open Bookcase
MNM3678
36"W x 12"D x 78"H
List: \$2,576.00

UNIQUE FINISH

Natural finish with chocolate
solid wood framed legs



ADDITIONAL PRODUCTS

60"W Writing Desk
MNM384
60"W x 30"D x 31"H
List: \$2,201.00

2 Drawer Lateral File
MNM450
34"W x 21"D x 31"H
List: \$2,214.00

57"W Sit/Stand Desk
MNM384T (Top Only)
57"W x 24"D x 6"H
List: \$1,624.00

Mobile Pedestal
Box/File
MNM202
18"W x 20"D x 24"H
List: \$1,477.00

See Pages 77-78 for
available 48" HAT Units

Some items in this collection come
ready-to-assemble.



NA Natural

E L Shape Open Desk w/Right Return
MNM386R (Desk)
MNM386RR (Return)
Desk: 66"W x 30"D x 31"H
Return: 48"W x 21"D x 31"H
List: \$2,167.00 (Desk)
List: \$1,434.00 (Return)

Note: Must purchase both desk & return.
Return is **not** reversible.





ARTISAN
Cement Finish

Executive Typical ARTISAN2
Total List: \$7,654.00
Includes: MNC386R, MNC386RR, MNC202 & MNC3678
Excludes Accessories

A L Shape Open Desk w/Right Return
MNC386R (Desk)
MNC386RR (Return)
Desk: 66"W x 30"D x 31"H
Return: 48"W x 21"D x 31"H
List: \$2,167.00 (Desk)
List: \$1,434.00 (Return)
*Note: Must purchase both desk & return.
Return is not reversible.*

B Mobile Pedestal Box/File
MNC202
18"W x 20"D x 24"H
List: \$1,477.00

C Open Bookcase
MNC3678
36"W x 12"D x 78"H
List: \$2,576.00

Bookcase w/Doors
MNC3678D
36"W x 12"D x 78"H
List: \$2,796.00

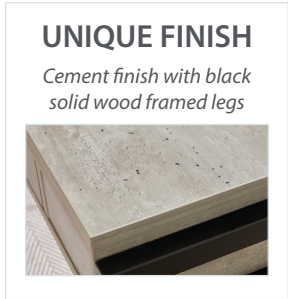

ADDITIONAL PRODUCTS

66"W Executive Desk
MNC680
66"W x 30"D x 31"H
List: \$3,656.00

Executive Hutch
MNC682
66"W x 12"D x 47½"H
List: \$2,354.00

Knee Space Credenza
MNC689
66"W x 21"D x 31"H
List: \$3,287.00

2 Drawer Lateral File
MNC450
34"W x 21"D x 31"H
List: \$2,214.00

60"W Writing Desk
MNC384
60"W x 30"D x 31"H
List: \$2,201.00

57"W Sit/Stand Desk
MNC384T (Top Only)
57"W x 24"D x 6"H
List: \$1,624.00

See Pages 77-78 for available 48" HAT Units

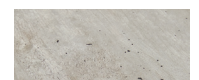

CT Cement

Some items in this collection come ready-to-assemble.



NEW! LUCCA
Walnut with Charcoal Finish

Pictured w/Palma Seating

A L Shape Desk w/Reversible Return OSXD2001
Desk: 72"W x 30"D x 30"H
Return: 40³/₁₆"W x 20"D x 27¹/₄"H
List: \$1,400.00

B 2 Drawer Lateral File OSXS2003
35"W x 20"D x 30"H
List: \$1,200.00

C 5 Shelf Bookcase OSXS2004
47¹/₄"W x 15"D x 69¹/₂"H
List: \$1,250.00

D 3 Shelf Console Bookcase OSXS2005
47¹/₄"W x 15"D x 43"H
List: \$850.00

E Mobile Pedestal Box/File OSXP2002
16¹/₄"W x 22³/₁₆"D x 23³/₁₆"H
List: \$800.00

F 60"W Conference Table OSXC2006
60"W x 30"D x 30"H
List: \$925.00



Store Books Or Knickknacks With These Cubicle Shelves



Lateral File & Mobile Pedestal Come With Locks On Top Drawer



SLEEK & MODERN PULLS

Lateral file and mobile pedestal come with black metal pulls for Walnut with Charcoal finish



Lateral file and mobile pedestal come with white metal pulls for Cypress with Pearl White finish





NEW! LUCCA
Cypress with Pearl White Finish

Pictured w/Merak Seating

FEATURES

- Contemporary design with 1.8" thick tops and sides; 5-Shelf and 3-Shelf bookcases have 1.5" thick tops, sides and shelves
- Unique two-tone color design in two color combinations
- Adjustable foot levelers available on L Shape Desk, 2 Drawer Lateral File, Bookcases and Conference Table
- Manufactured with durable, melamine laminate
- Some assembly required; Lateral File & Mobile Pedestal come fully assembled



WR Walnut
w/Charcoal

CW Cypress
w/Pearl White

*Four Chairs Can Fit Comfortably
With Two On Each Side*



Shown in Walnut w/Charcoal



Pictured w/Merak Seating



Pictured w/Palma Seating



SIENNA

Multi-Person Typical SIENNA5
 Total List: \$9,476.00
 Includes: OX9170 (2), OX9180 (2), OX9WDS80 (2), OX9DRW80 (2), OX9MP01 (2), OX956 (2) & OX9WD56 (2)
 Excludes Seating & Accessories
 Pictured w/CoolMesh & Value Seating

- A 60"W Table Top w/Two Legs OX9130**
60"W x 29½"D x 29½"H
List: \$758.00
- 66"W Table Top w/Two Legs OX9150**
66"W x 29½"D x 29½"H
List: \$784.00
- 71"W Table Top w/Two Legs OX9190**
71"W x 29½"D x 29½"H
List: \$830.00
- 82"W Table Top w/Two Legs OX9170**
82⅛"W x 35½"D x 29½"H
List: \$1,102.00

- B Modesty Panel (w/Hanging Brackets) OX9MP03**
(For OX903)
38½"W x ¾"D x 14½"H
List: \$151.00
- OX9MP01**
(For OX901 & OX9170)
50⅜"W x ¾"D x 14½"H
List: \$209.00

- C 63"W Open Side Return OX9180**
63"W x 21⅒"D x 25¾"H
List: \$907.00
- D Optional Sliding Doors (For OX9180) OX9WDS80***
29½"W x ¾"D x 20⅛"H
List: \$282.00

- E Optional 2 Drawer Storage Doors (For OX9180) OX9DRW80*** (Set of 2)
30⅓"W x 19¾"D x 20½"H
List: \$830.00



Open Side Return Adjustable Shelves

ADDITIONAL PRODUCTS



- F Storage Credenza (w/B/B/F & Sliding Doors) OX9245**
47¼"W x 17¾"D x 29½"H
List: \$1,393.00

Note: PLLOCKCOREKIT does not work with OX9245.



- Mobile Pedestal Box/File (G) OX9007**
16"W x 22½"D x 22½"H
List: \$861.00

Pictured w/Top Cushion

- Top Cushion CUSH1623 (For OX9007)**
List: \$237.00

Top Cushion Upholstery Colors

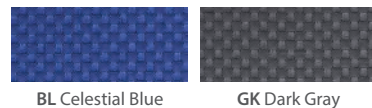

BL Celestial Blue

GK Dark Gray

Laminate Finishes



CG Coastal Gray

WH White
 (*Select SKUs)
 (OX9WDS80 & OX9DRW80 Only)

Some items in this collection come ready-to-assemble.



SIENNA

Executive Typical SIENNA6

Total List: \$4,507.00
Includes: OX903, OX954, OX9WD54,
OX956, OX9WD56 & OX9245
Excludes Seating & Accessories
Pictured w/Cade & Franklin Seating

G 60"W Desk (w/o Modesty)
OX903
60"W x 29½"D x 29½"H
List: \$949.00

H Open Bookcase (No Doors)
OX956
31½"W x 17¾"D x 65"H
List: \$936.00

I Laminate Door Kits
(For OX956)
OX9WD56*
29½"W x ¾"D x 60"H
List: \$472.00

**J 94"W Boat Shape
Conference Table**
(w/Grommet)

OX9236
94½"W x 47¼"D x 29½"H
List: \$1,874.00

66"W Desk (w/o Modesty)
OX902
66"W x 29½"D x 29½"H
List: \$975.00

K Open Bookcase (No Doors)
OX954
31½"W x 17¾"D x 29½"H
List: \$519.00

L Laminate Door Kits
(For OX954)
OX9WD54
31½"W x ¾"D x 24¾"H
List: \$238.00

M 42" Round Meeting Table
(Not Pictured)

OX9127
42"Dia x 29½"H
List: \$944.00

71"W Desk (w/o Modesty)
OX901
71"W x 29½"D x 29½"H
List: \$1,021.00

N Glass Door Kits (Not Pictured)
OX9GD56 *(For OX956)*
29½"W x ¾"D x 59"H
List: \$1,050.00

O Lock Core Kit (Not Pictured)
PLLOCKCOREKIT
List: \$50.00

Available in BK Black or SI Silver

*Note: Please ask your Sales Rep
about keying-alike or differently for
the PLLOCKCOREKIT.*



L Shape Typical SIENNA7

Total List: \$3,330.00
Includes: OX9170, OX9180,
OX9WDS80, OX9DRW80 & OX9MP01
Excludes Seating & Accessories
Pictured w/CoolMesh Basic Seating



Pictured w/Franklin Seating



**Executive Typical
PALISADES1**

Total List: \$11,372.00
 108"W x 67½"H
 Includes: EV7230DP, EVC350,
 EV7224C, EVP400 & EVS100
 Excludes Seating & Accessories
 Pictured w/Palma Seating

PALISADES

**A 60"W Double Pedestal Desk
EV6030DP**
 60"W x 30"D x 29½"H
 List: \$3,305.00

**66"W Double Pedestal Desk
EV6630DP**
 66"W x 30"D x 29½"H
 List: \$3,349.00

**72"W Double Pedestal Desk
EV7230DP**
 72"W x 30"D x 29½"H
 List: \$3,455.00

**B Hutch w/Supports
& Sliding Doors
EVC350**
 72"W x 15"D x 37¼"H
 List: \$1,872.00

**Wall Mounted Hutch
w/Sliding Doors
EVC300**
 72"W x 15"D x 17¾"H
 List: \$1,609.00

**C Double Pedestal Credenza
EV7224C**
 72"W x 24"D x 29½"H
 List: \$2,963.00



Wall Mountable

**D 2 Drawer Lateral File
EVP400**
 36"W x 24"D x 29½"H
 List: \$1,989.00

**E 38"H Open
Bookcase Hutch
EVS100**
 36"W x 15½"D x 38"H
 List: \$1,093.00

**F 67"H Open
Bookcase Hutch
EVS300**
 36"W x 15½"D x 67"H
 List: \$1,745.00

ADDITIONAL PRODUCTS



**60"W Single Pedestal Desk
EV6030SP**
 60"W x 30"D x 29½"H
 List: \$2,716.00

**66"W Single Pedestal Desk
EV6630SP**
 66"W x 30"D x 29½"H
 List: \$2,760.00

**72"W Single Pedestal Desk
EV7230SP**
 72"W x 30"D x 29½"H
 List: \$2,866.00



**72"W Height Adjustable Desk
EVH400**
 72"W x 30"D x 29½-47¼"H
 List: \$4,417.00

**Mobile Pedestal
Box/Box/File
EVP300**
 15½"W x 20"D x 24½"H
 List: \$978.00



EVP300 - Mobile Pedestal
Locking



GG Gauntlet Gray
w/Graphite Metal



F



**Executive Typical
PALISADES7**
Total List: \$14,635.00
144"W x 59"H
Includes: EV6030DP, EVP400
(2), EVS700 (2), EVS600 (2),
EVS620, EVS710 & EVC300
Excludes Seating & Accessories
Pictured w/Palma Seating

PALISADES

**G Storage Cabinet
EVS700**
36"W x 24"D x 29½"H
List: \$1,364.00

**H Bookcase Hutch
EVS600**
36"W x 24"D x 29½"H
List: \$1,093.00

**I Optional Laminate Doors
(For use with EVS700)**
EVS710
36"W x 24"D x 29½"H
List: \$279.00

**J Optional Glass Doors
(For use with EVS700)**
EVS720
36"W x 24"D x 29½"H
List: \$334.00

**K Optional Laminate Doors
(For use with EVS600)**
EVS610
36"W x 24"D x 29½"H
List: \$357.00

**L Optional Glass Doors
(For use with EVS600)**
EVS620
36"W x 24"D x 29½"H
List: \$550.00



Storage Cabinet
Without Doors



Bookcase Hutch
Without Doors

ADDITIONAL PRODUCTS



**Coffee Table
EVS550**
47¼"W x 23⅝"D x 17"H
List: \$1,148.00



**End Table
EVS500**
20½"W x 20½"D x 26"H
List: \$826.00

OPTIONAL POWER



**Optional Power Unit
EVT1050**
(For Pedestal Desks)
List: \$234.00

Note: Use with the main pedestal unit of a single or double pedestal desk. EVT1050 is not daisy chainable.

UNIQUE PULL FEATURES



Modern graphite metal pulls complement the gray frame finish



GG Gauntlet Gray
w/Graphite Metal



PALISADES

Height Adjustable Typical PALISADES6
 Total List: \$9,323.00
 72"W x 78"D x 29½-47¼"H
 Includes: EVH200 & EV7224C
 Excludes Seating & Accessories
 Pictured w/Palma Seating

K L Shape Electric Height Adjustable Desk w/Single Pedestal EVH200

Overall: 72"W x 78"D x 29½"H
 Desk: 72"W x 30"D x 29½"H
 Return: 48"W x 24"D x 29½-47¼"H
 List: \$6,360.00

Note: Only the return is height adjustable.

L L Shape Electric Height Adjustable Desk EVH100

Overall: 72"W x 78"D x 29½-47¼"H
 Desk: 72"W x 30"D x 29½-47¼"H
 Return: 48"W x 24"D x 29½-47¼"H
 List: \$7,384.00

Note: Desk and return are fully height adjustable.



Fully Height Adjustable

M L Shape Double Pedestal Desk w/Reversible Return EV6030L

Overall: 66"W x 78"D x 29½"H
 Desk: 66"W x 30"D x 29½"H
 Return: 48"W x 24"D x 29½"H
 List: \$4,377.00

EV6630L

Overall: 66"W x 78"D x 29½"H
 Desk: 66"W x 30"D x 29½"H
 Return: 48"W x 24"D x 29½"H
 List: \$4,421.00

EV7230L

Overall: 72"W x 78"D x 29½"H
 Desk: 72"W x 30"D x 29½"H
 Return: 48"W x 24"D x 29½"H
 List: \$4,527.00



EVRC1R - User Side

Reception Desk (Desk Only)

EVRC1L (Left)
EVRC1R (Right)
 87½"W x 37"D x 47½"H
 List: \$4,939.00

Optional Reversible Return

EVRC2
 47¼"W x 23¼"D x 41¼"H
 List: \$950.00



Pictured w/EVRC1L (Front Side)



GG Gauntlet Gray
 w/Graphite Metal



**Executive Typical
PALISADES5**
Total List: \$7,786.00
72"W x 102"D x 67½"H
Includes: EV7230U & EVC350
Excludes Seating & Accessories
Pictured w/Palma Seating

PALISADES

N U Shape Double Pedestal Desk w/Reversible Bridge EV7230U

Overall: 72"W x 102"D x 29½"H
Desk: 72"W x 30"D x 29½"H
Bridge: 48"W x 24"D x 29½"H
Credenza: 72"W x 24"D x 29½"H
List: \$5,914.00

FEATURES

- Laminate is water, scratch, stain, fade & mildew resistant
- Pedestal desks include a full length mesh modesty panel for privacy
- Base frame is made from durable metal with a graphite finish



PRODUCT FEATURES

Laminate tops have a 1.65" thick PVC edge and floating look



Modern graphite pulls complement the frame finish completely

CONFERENCE PRODUCTS



72"W Sitting Height Conference Table

(Pre-cut Grommet Insert + Cover)
EVT6
72"W x 47¼"D x 29¾"H
List: \$2,814.00



96"W Standing Height Table

(6 Cutouts for EVT900BK)
EVST8
95¼"W x 47¼"D x 42"H
List: \$5,346.00



42"W Round Conference Table EV42R

42"W x 42"D x 29¾"H
List: \$1,215.00

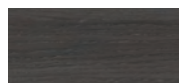

GG Gauntlet Gray
w/Graphite Metal

Note: **PLTBPOWER** is an optional power insert option that fits **EVT6**, **EVT8** & **EVT10**.

OPTIONAL POWER



Daisy Chain Power Module

(For EVST8 Only)
EVT900BK (Black Only)
List: \$660.00

Note: Daisy chained up to (3) power modules only. Power modules are sold separately as a set of (3).

96"W Sitting Height Conference Table

(2 Pre-cut Grommet Inserts + Covers)
EVT8 (Not Pictured)
95¼"W x 47¼"D x 29¾"H
List: \$2,943.00

120"W Sitting Height Conference Table

(2 Pre-cut Grommet Inserts + Covers)
EVT10 (Not Pictured)
120"W x 47¼"D x 29¾"H
List: \$5,080.00



Pictured w/EV42R, (2) EVS300 & Palma Seating



EPITOME

Executive Typical EPITOME4
 Total List: \$6,232.00
 Includes: IDD3072, IDR3624, IDDMOD, HIL36 & IDPBF
 Excludes Accessories

A 59"W Industrial Desk w/Metal Corners
 (No Modesty Panel)
IDD3060
 59½"W x 29½"D x 29½"H
 List: \$2,421.00

B 35"W Industrial Return w/Metal Corners
IDR3624
 35¾"W x 23¾"D x 29½"H
 List: \$1,441.00

C Metal Modesty Panel IDDMOD
 52¾"W x ¾"D x 15¾"H
 List: \$365.00

D 2 Drawer Lateral File
 (Locking - from Riveted)
HIL36
 35"W x 17¾"D x 29½"H
 List: \$1,140.00

E Box/File Pedestal
 (Locking)
IDPBF
 15½"W x 19½"D x 24"H
 List: \$715.00

71"W Industrial Desk w/Metal Corners
 (No Modesty Panel)
IDD3072
 70¾"W x 29½"D x 29½"H
 List: \$2,571.00

41"W Industrial Return w/Metal Corners
IDR4224
 41¾"W x 23¾"D x 29½"H
 List: \$1,245.00

47"W Industrial Return w/Metal Corners
IDR4824
 47¼"W x 23¾"D x 29½"H
 List: \$1,294.00

Riveted Lateral File Pairs Well With Epitome



Includes A Single Lock For All Drawers



59"W Industrial Desk Shown without Optional Metal Modesty Panel

UNIQUE PULL FEATURE



Black metal pulls offers a more rustic, industrial look



DB Distressed Brown w/Distressed Charcoal



**Conference Typical
EPITOME2**
 Total List: \$5,806.00
 Includes: IDC9648 & (2) HIL36
 Excludes Seating & Accessories
 Pictured w/Tre Lite Seating

EPITOME

**F 94"W Conference Table
IDC9648**
 94 $\frac{3}{8}$ "W x 47 $\frac{1}{2}$ "D x 29 $\frac{1}{2}$ "H
 List: \$3,526.00



*Pairs Well With
the Riveted*



Profile View



Front View



PRODUCT FEATURES

Industrial, sleek metal framework on corners with exposed hardware



Durable, A-Frame style metal legs with a distressed charcoal finish



**DB Distressed Brown
w/Distressed Charcoal**





NEW! Executive Typical RIVETED6
 Total List: \$7,316.00
 106 $\frac{1}{8}$ "W x 29 $\frac{1}{2}$ "H
 Includes: HID3071, HIR3024, & HIL36 (3)
 Excludes Seating, Conference Tables & Accessories
 Pictured w/Tre Lite Seating

RIVETED

A 59"W Industrial Desk w/Metal X Base
(Bottom Modesty Included)
HID3060
 59 $\frac{1}{8}$ "W x 29 $\frac{1}{2}$ "D x 29 $\frac{1}{2}$ "H
 List: \$2,340.00

B 29 $\frac{1}{2}$ "W Industrial Return w/Metal X Base
(Bottom Modesty Included)
HIR3024
 29 $\frac{1}{2}$ "W x 23 $\frac{3}{8}$ "D x 29 $\frac{1}{2}$ "H
 List: \$1,518.00

C 2 Drawer Lateral File HIL36
 35 $\frac{3}{8}$ "W x 17 $\frac{3}{4}$ "D x 29 $\frac{1}{2}$ "H
 List: \$1,140.00

*HIR3024 - Profile View
 Includes Bottom Modesty Panel*



71"W Industrial Desk w/Metal X Base
(Bottom Modesty Included)
HID3071
 70 $\frac{7}{8}$ "W x 29 $\frac{1}{2}$ "D x 29 $\frac{1}{2}$ "H
 List: \$2,378.00

41"W Industrial Return w/Metal X Base
(Bottom Modesty Included)
HIR4124
 41 $\frac{3}{8}$ "W x 23 $\frac{3}{8}$ "D x 29 $\frac{1}{2}$ "H
 List: \$1,599.00

FEATURES

- Heavy-duty, industrial metal cross-bar base with a distressed charcoal finish
- Desks include a bottom mesh, metal modesty panel for optimal privacy
- 2" Thick, distressed laminate tops
- Black metal pulls offers a more rustic, industrial look



*59"W Industrial Desk
 Comes With Two Grommets*



DB Distressed Brown w/Distressed Charcoal

Some items in this collection come ready-to-assemble.

NEED ADDITIONAL STORAGE?

(from the Epitome)



Box/File Pedestal
(Locking)
IDPBF
 15 $\frac{1}{2}$ "W x 19 $\frac{5}{8}$ "D x 24"H
 List: \$715.00



Executive Typical RIVETED2
 Total List: \$8,101.00
 Includes: HIC3071, HIC7130, HIH7115, HIB3566 & HIB3536
 Excludes Seating & Accessories
 Pictured w/Obsidian Seating

RIVETED

**D Hutch w/Doors
 HIH7115**

70 $\frac{7}{8}$ "W x 14 $\frac{3}{4}$ "D x 36 $\frac{3}{8}$ "H
 List: \$1,584.00

**E Double Pedestal
 Credenza
 HIC7130**

70 $\frac{7}{8}$ "W x 23 $\frac{5}{8}$ "D x 29 $\frac{1}{2}$ "H
 List: \$2,181.00

**F 66"H Metal Bookcase
 HIB3566**

35 $\frac{3}{8}$ "W x 15 $\frac{3}{4}$ "D x 66 $\frac{1}{8}$ "H
 List: \$1,225.00

**G 36"H Metal Bookcase
 HIB3536**

35 $\frac{3}{8}$ "W x 15 $\frac{3}{4}$ "D x 36 $\frac{3}{8}$ "H
 List: \$733.00

**H Square Conference
 Table w/Cubed Base
 HIC4848**

47 $\frac{1}{4}$ "W x 47 $\frac{1}{4}$ "D x 29 $\frac{1}{2}$ "H
 List: \$1,969.00



HIC7130 - Front View
 Includes Two Locking Top Drawers

NEW! Conference Typical RIVETED5

Total List: \$5,885.00
 Includes: HIC4848,
 HIB3566 (2) & HIB3536 (2)
 Excludes Accessories



DB Distressed Brown
 w/Distressed Charcoal

Some items in this collection come ready-to-assemble.





RALEIGH

Pictured in Walnut w/Black

A 60"W Double Pedestal Steel Desk
QSOSDP6030
 60"W x 30"D x 29½"H
 List: \$2,864.00

C 66"W Single Right Pedestal Desk
QSOSP6630
 66"W x 30"D x 29½"H
 List: \$2,832.00

48"W Single Right Pedestal Desk
QSOSP4830
 48"W x 30"D x 29½"H
 List: \$2,456.00

45"W Single Right Pedestal Desk
QSOSP4524
 45"W x 24"D x 29½"H
 List: \$2,290.00

B Steel Bookcase - 4 Shelves
QSOSB4SLF60
 34½"W x 13"D x 60"H
 List: \$1,098.00
See Page 219 For Additional Steel Bookcase Sizes



Pictured in Walnut w/Black

ADDITIONAL PRODUCTS



42"W Single Pedestal Steel Return
QSOSR4224
 42"W x 24"D x 29½"H
 List: \$2,006.00

PRODUCT FEATURES

Center drawer has core-removable locks with a central locking system



Fully extending file & box pedestal drawers with precision ball-bearing suspension



PO Oak
w/Putty

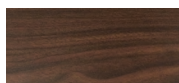

BW Walnut
w/Black



CM Mahogany
w/Charcoal

QS = QUICKSHIP

Items in this collection come fully assembled.



BEDFORD

Pictured in Mahogany w/Charcoal

A 72"W Double Pedestal Desk

QSOSMD7236

72"W x 36"D x 29½"H

List: \$4,170.00

60"W Double Pedestal Desk

QSOSMD6030

60"W x 30"D x 29½"H

List: \$3,663.00

B 72"W Double Pedestal Credenza

QSOSMCD7224

72"W x 24"D x 29½"H

List: \$3,622.00

60"W Double Pedestal Credenza

QSOSMCD6024

60"W x 24"D x 29½"H

List: \$3,556.00

FEATURES

- Durable, 1½" thick laminate work surface top
- Full-height end panels with leveling glides included
- Wire management grommets included
- Precision, ball-bearing suspensions with full extension file & box drawers
- Core-removable locks included

ADDITIONAL PRODUCTS

72"W Single Right Pedestal Credenza

QSOSMC7224

72"W x 24"D x 29½"H

List: \$3,385.00

48"W Single Right Pedestal Desk

QSOSMS4830

48"W x 30"D x 29½"H

List: \$3,127.00

48"W Single Right Pedestal Return

QSOSMR4824

48"W x 24"D x 29½"H

List: \$2,855.00

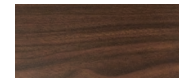

BW Walnut w/Black



CM Mahogany w/Charcoal

QS = QUICKSHIP

Items in this collection come fully assembled.

WHITLEY



Pictured in Walnut w/Black

A 60"W Mobile Double Pedestal Teacher's Desk

QSOSTDM6030

60"W x 30"D x 29½"H

List: \$3,099.00



WP White w/Platinum

B 48"W Mobile Single Pedestal Teacher's Desk

QSOSTSM4830

48"W x 30"D x 29½"H

List: \$2,550.00



BW Walnut w/Black



QS = QUICKSHIP

Items in this collection come fully assembled.



ELEVATE YOUR MODERN OFFICE
WITH OUR BEST-SELLING
OS LAMINATE COLLECTION

Pictured w/Oslo Seating & OS269 Typical

Now Available in the New! Finish - American Elm



*Pictured w/Palma Seating
& NEW! OSTYP306 Typical*

FEATURES



*Standard Black
Wire Grommets*



*Standard Silver
Crescent Pulls*



*Beautiful
Wood Grain*

*Experience the transformative power of American Elm,
where we redefine what an office can be.*

This exceptional line offers a wide array of components and sizes, allowing you to effortlessly customize your workspace to meet your every need.



Uplift your workplace to new heights, where creativity thrives, and productivity soars.



OS LAMINATE
NEW! American Elm Finish

NEW FINISH! U Shape Typical OS268†
 Total List: \$4,300.00
 106½"W x 95"D x 65½"H
 Excludes Seating & Accessories
 Pictured w/Palma Seating



NEW FINISH! OS127 | Components

SKU #	QTY	DESCRIPTION	W x D x H
PL101†	1	Desk Shell	71 x 35½ x 29½
PL145†	1	Reversible Return	47 x 24 x 29½
PL166†	1	Deluxe Full Pedestal - B/B/F	15½ x 22 x 28½
PL175†	1	Deluxe Full Pedestal - F/F	15½ x 22 x 28½
PL144OH†	1	Open Hutch	71 x 15 x 36
PL44SLIDESGD	2	Sliding Glass Doors (Sets of 2)	18 x ½ x 15¾
PL44RAIL	1	Rails For Glass Doors	69 x 1 x 1
PL118	1	Tack Board (Visconti Fabric)	68% x ½ x 16½

NEW FINISH! L Shape Typical OS127†

Total List: \$4,522.00
 71"W x 83"D x 65½"H
 Excludes Seating & Accessories
 Pictured w/Palma Seating

NEW FINISH! OS268 | Components

SKU #	QTY	DESCRIPTION	W x D x H
PL101†	1	Desk Shell	71 x 35½ x 29½
PL193†	1	Bridge	35 x 24 x 29½
PL143†	1	Credenza Shell	71 x 24 x 29½
PL112†	1	Two Drawer Lateral File	35½ x 22 x 29½
PL144OH†	1	Open Hutch	71 x 15 x 36
PL44LD†	2	Laminate Hutch Doors (Set of 2)	17 x ¾ x 15¾
PL118	1	Tack Board (Gray Fabric)	68% x ½ x 16½

Standard Pull Options

Customize Your Pull Options - See Page 35



NEW! AE American Elm w/Silver Pulls
 (†Select SKUs)

CG Coastal Gray w/Silver Pulls

ES Espresso w/Silver Pulls



MW Modern Walnut w/Silver Pulls

MH Mahogany w/Black Pulls

CH Cherry w/Black Pulls



WH White w/Silver Pulls

MA Maple w/Black Pulls



OS LAMINATE
NEW! American Elm Finish

NEW FINISH! U Shape Typical OS21†
Total List: \$7,350.00
106½"W x 112"D x 65½"H
Excludes Seating & Accessories
Pictured w/Palma Seating



NEW! OSTYP306 | Components

SKU #	QTY	DESCRIPTION	W x D x H
PL189†	1	Bow Front Desk Shell	71 x 36/41 x 29½
PL170†	1	Bridge	47 x 24 x 29½
PL143†	1	Credenza Shell	71 x 24 x 29½
PL166†	1	Deluxe Full Pedestal - B/B/F	15½ x 22 x 28½
PL112†	2	Two Drawer Lateral File	35½ x 22 x 29½
PL152†	2	Storage Cabinet	35½ x 22 x 37¼
PL144OH†	1	Open Hutch	71 x 15 x 36
PL44LD†	2	Laminate Hutch Doors (Set of 2)	17 x ¾ x 15¾
PL118	1	Tack Board (Gray Fabric)	68% x ½ x 16½

NEW! U Shape Typical OSTYP306†

Total List: \$8,618.00
142"W x 112"D x 65½"H
Excludes Seating & Accessories
Pictured w/Palma Seating

NEW FINISH! OS21 | Components

SKU #	QTY	DESCRIPTION	W x D x H
PL189†	1	Bow Front Desk Shell	71 x 36/41 x 29½
PL170†	1	Bridge	47 x 24 x 29½
PL143†	1	Credenza Shell	71 x 24 x 29½
PL166†	1	Deluxe Full Pedestal - B/B/F	15½ x 22 x 28½
PL144OH†	1	Open Hutch	71 x 15 x 36
PL44SGD	1	Silver Frame Glass Doors (Sets of 2)	17 x ¾ x 15¾
PL112†	1	Two Drawer Lateral File	35½ x 22 x 29½
PL152†	1	Storage Cabinet	35½ x 22 x 37¼
PL152SGD	1	Silver Frame Glass Cabinet Doors	17½ x ½ x 36½
GBM1769	1	Magnetic Glass White Board	68½ x ½ x 16½

Standard Pull Options

Customize Your Pull Options - See Page 35



NEW! AE American Elm w/Silver Pulls
(†Select SKUs)

CG Coastal Gray w/Silver Pulls

ES Espresso w/Silver Pulls



MW Modern Walnut w/Silver Pulls

MH Mahogany w/Black Pulls

CH Cherry w/Black Pulls



WH White w/Silver Pulls

MA Maple w/Black Pulls



OS LAMINATE
NEW! American Elm Finish

NEW! U Shape Typical OSTYP307†
Total List: \$4,432.00
71"W x 101"D x 65½"H
Excludes Seating & Accessories
Pictured w/Palma Seating



NEW FINISH! OS86 | Components

SKU #	QTY	DESCRIPTION	W x D x H
PL101†	1	Desk Shell	71 x 35½ x 29½
PL145†	1	Reversible Return	47 x 24 x 29½
PL166†	1	Deluxe Full Pedestal - B/B/F	15½ x 22 x 28½
PL175†	1	Deluxe Full Pedestal - F/F	15½ x 22 x 28½
PL144OH†	1	Open Hutch	71 x 15 x 36
PL44LD†	1	Laminate Hutch Doors (Set of 2)	17 x ¾ x 15¾
PL118	1	Tack Board (Gray Fabric)	68% x ½ x 16½

NEW FINISH! L Shape Typical OS86†

Total List: \$3,943.00
71"W x 83"D x 65½"H
Excludes Seating & Accessories
Pictured w/Palma Seating

NEW! OSTYP307 | Components

SKU #	QTY	DESCRIPTION	W x D x H
PL143†	1	Credenza Shell	71 x 24 x 29½
PL114†	1	Combo Lateral File - B/B/F/Lat.	31 x 22 x 29½
PL144OH†	1	Open Hutch	71 x 15 x 36
PL44LD†	1	Laminate Hutch Doors (Set of 2)	17 x ¾ x 15¾
PL170†	1	Bridge	47 x 24 x 29½
PL105†	1	Desk Shell	71 x 30 x 29½
PL118	1	Tack Board (Gray Fabric)	68% x ½ x 16½

Additional Pull Options

Customize Your Pull Options - See Page 35

		
Rectangular Pull Silver Only	Modern Bar Pull Silver	Modern Bar Pull Black
		
Modern Metro Pull Silver	Modern Metro Pull Black	Modern Metro Pull Gray
		
Mid-Century Pull Silver	Mid-Century Pull Black	Mid-Century Pull Gray



OS LAMINATE

Pictured w/Cade Seating & OS170 Typical



NEW! AE American Elm
(†Select SKUs)

CG Coastal Gray

ES Espresso

MW Modern Walnut

MH Mahogany

CH Cherry

WH White
(Select SKUs)

MA Maple
(Select SKUs)

Note: American Elm **only** available for select SKUs. Select SKUs are notated by a † mark at the end of their SKU.

A Desk Shell - 29½"H

PL104†	47"W x 24"D x 29½"H	\$497.00
PL121†	47"W x 30"D x 29½"H	\$533.00
PL103†	60"W x 30"D x 29½"H	\$541.00
PL102†	66"W x 30"D x 29½"H	\$585.00
PL105†	71"W x 30"D x 29½"H	\$726.00
PL101†	71"W x 36"D x 29½"H	\$739.00

B Desk Shell w/Corner Extension - 29½"H

PL178R† (Rt)	71"W x 30/42"D x 29½"H	\$1,174.00
PL178L† (Lt)	71"W x 30/42"D x 29½"H	\$1,174.00

C End Panel Leg (For Bullet Tops)

PLTEP30	30"W (For PLT131T)	\$289.00
PLTEP36	36"W (For PLT147T)	\$338.00

D Half Gable (For End Panel or Credenza Shell)

PL142+*	12¾"W x 1"D x 28"H	\$104.00
----------------	--------------------	----------

*Note: PL142 replaces the full gable so that a credenza shell can be used in a return application.

E Credenza Shell - 29½"H

PL129†	60"W x 24"D x 29½"H	\$547.00
PL111†	66"W x 24"D x 29½"H	\$562.00
PL143†	71"W x 24"D x 29½"H	\$593.00

F Bullet Tops (Tops Only - Must Order Leg, Half Gable & End Panel)

PLT131T	66"W x 30"D x 1"H	\$472.00
PLT147T	72"W x 36"D x 1"H	\$578.00

PLT131T is available in **ES Espresso**, **MA Maple**, **MW Modern Walnut** & **CG Coastal Gray** Only.

PLT147T is available in **ES Espresso**, **MA Maple**, **MW Modern Walnut** & **CG Coastal Gray** Only.

G Post Leg (For PLT131T & PLT147T Only)

OS720	Single Post Leg	\$235.00
--------------	-----------------	----------

Available in **BK Matte Black** or **SI Silver**

Note: OS720 can be shipped by a small package carrier. 📦

H Corner Desk Shell - 29½"H

PL134	42"W x 42"D x 29½"H	\$776.00
PL163	36"W x 36"D x 29½"H	\$880.00

PL134 & PL163 are available in **CH Cherry**, **MH Mahogany**, **ES Espresso**, **MW Modern Walnut** & **CG Coastal Gray** Only.

I Reversible Return - 29½"H

PL194†	24"W x 24"D x 29½"H	\$344.00
PL179†	30"W x 24"D x 29½"H	\$359.00
PL198	35"W x 20"D x 29½"H	\$377.00
PL192†	35"W x 24"D x 29½"H	\$377.00
PL146†	42"W x 20"D x 29½"H	\$487.00
PL196†	42"W x 24"D x 29½"H	\$487.00
PL145†	47"W x 24"D x 29½"H	\$501.00

Note: PL194 & PL179 do not have grommets.

ADDITIONAL PRODUCTS



Bow Front Desk Shell - 29½"H

PL187†	66"W x 30/35½"D x 29½"H	\$946.00
PL189†	71"W x 36/41"D x 29½"H	\$946.00

Bow Front Desk Shell w/Corner Ext. - 29½"H

PL177R (Rt)	71"W x 30/36/42/48"D x 29½"H	\$1,174.00
PL177L (Lt)	71"W x 30/36/42/48"D x 29½"H	\$1,174.00



Credenza w/Corner Extension - 29½"H

PL181R† (Rt)	66"W x 24/36"D x 29½"H	\$845.00
PL181L† (Lt)	66"W x 24/36"D x 29½"H	\$845.00
PL182R† (Rt)	71"W x 24/36"D x 29½"H	\$859.00
PL182L† (Lt)	71"W x 24/36"D x 29½"H	\$859.00

PL177R & PL177L are available in **CH Cherry**, **ES Espresso**, **MH Mahogany**, **MW Modern Walnut**, **CG Coastal Gray** & **WH White** Only.



Bridge - 29½"H

PL188	30"W x 24"D x 29½"H	\$341.00
PL193†	35"W x 24"D x 29½"H	\$344.00
PL197†	42"W x 24"D x 29½"H	\$368.00
PL170†	47"W x 24"D x 29½"H	\$411.00

PULL OPTIONS



Crescent Pull OSPULLHL

List: \$46.00 ea.

SI Silver or BK Black



Rectangular Pull OSPULLR

List: \$46.00 ea.

SI Silver



Modern Metro Pull OSPULLCYL

List: \$46.00 ea.

SI Silver, BK Black
or GR Gray



Modern Bar Pull OSPULLBAR

List: \$46.00 ea.

SI Silver or BK Black



Mid-Century Pull OSPULLMC

List: \$46.00 ea.

SI Silver, BK Black
or GR Gray



OS112 w/Rectangular Pulls - See Page 43

STEP FRONT DESKS



A Bow Top w/Modesty Panel

PL489†* 71"W x 35½/41"D \$761.00

B Glass Modesty Panel (For PL401 & PL489)

PL71SGM 40"W x 28"H \$724.00

Available in FR Frosted Glass

C False Pedestals

PL46836†** 15¾"W x 35½"D x 28½"H \$472.00

(For PL401 & PL489)

**Note: (2) False pedestals are required under PL401 & PL489.

D Desk Top w/Modesty Panel

PL401* 71"W x 35½"D \$625.00

*Note: Step front desk tops require (2) false pedestals for support.

All work surfaces are 29½"H. Top Thickness: (PL) 1" Thick. Measurements are approximate as they are rounded up to the next full inch.



NEW! AE American
Elm (†Select SKUs)

CG Coastal Gray

ES Espresso

Note: American Elm only available for select SKUs. Select SKUs are notated by a † mark at the end of their SKU.

STANDING HEIGHT DESKS



Pictured w/Rise Seating - See Page 169

Standing Table - 41"H

PLT4172† 72"W x 30"D x 41¾"H \$1,266.00

Note: PLT4172 is not compatible with attachable pedestals.



NEW! AE American
Elm (†Select SKUs)

CG Coastal Gray



ES Espresso

MW Modern Walnut

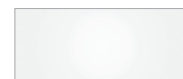

WH White

OS LAMINATE

HUTCHES WITH LAMINATE DOORS



Hutch w/Laminate Doors
PL125 47¼"W x 15"D x 36"H \$915.00
 Note: PL125 is not available in WH White.



OPTIONAL TACK BOARDS
 Add a fabric tack board for an easy solution to post messages and reminders while you work

HUTCHES WITHOUT DOORS



Open Hutch - 15" Depth
PL141OH† 60"W x 15"D x 36"H \$802.00
PL140OH† 66"W x 15"D x 36"H \$830.00
PL144OH† 71"W x 15"D x 36"H \$851.00

Wall Mounted Open Hutch
PL209OH 31"W x 15"D x 17"H \$519.00
PL208OH† 36½"W x 15"D x 17"H \$562.00
PL2044OH† 71"W x 15"D x 17"H \$946.00



Open Hutch - 14" Depth
PL153† 35½"W x 14"D x 36"H \$608.00



Open Hutch (Requires Supports)
PL1044OH† 71"W x 15"D x 17"H \$950.00
 Note: PL1044OH can not be wall mounted.

Hutch Supports (Sold as Pair)
PLTLPHS20 20"H \$341.00
PLTLPHS27 27"H \$405.00
 Available in BK Matte Black or SI Silver
 Note: Hutch Supports are only for PL1044OH & cannot work with wall mounted units.

OPTIONAL HUTCH ACCESSORIES



Fabric Tack Boards
PL115 (Fits PL141) 58"W x ½"D x 16½"H \$315.00
PL116 (Fits PL125) 45¼"W x ½"D x 16½"H \$299.00
PL117 (Fits PL140) 64"W x ½"D x 16½"H \$330.00
PL118 (Fits PL144) 68¾"W x ½"D x 16½"H \$359.00



Magnetic Glass White Board
GBM1769 (Fits PL144) 68½"W x ½"D x 16½"H \$445.00

Note: American Elm only available for select SKUs. Select SKUs are notated by a † mark at the end of their SKU.

OS LAMINATE



2 Sets of Doors



1 Set of Doors



2 Sets of Doors



1 Set of Doors



2 Sets of Doors

Note: Hutch doors come in Sets of 2. This allows the hutch to have a partial open storage. If you want a fully closed storage hutch, you will need (2) door kits.

OPTIONAL DOOR KITS FOR OPEN HUTCHES



Optional Laminate Doors (Set of 2)

PL40LD†	(For PL140)	\$82.00
PL41LD†	(For PL141 & PL209)	\$80.00
PL44LD*†	(See Below)	\$83.00

*Note: PL44LD is for PL144OH, PL208OH & PL2044OH.



Optional Silver Framed Glass Doors (Set of 2)

PL40SGD	(For PL140)	\$373.00
PL41SGD	(For PL141 & PL209)	\$373.00
PL44SGD*	(See Below)	\$373.00

*Note: PL44SGD is for PL144OH, PL208OH & PL2044OH.



Optional Sliding Glass Doors

PL44SLIDESGD*	(See Below)	\$256.00
PL44RAIL**	(See Below)	\$150.00

Available in SI Silver

Note: PL44SLIDESGD & PL44RAIL is for PL144OH & PL2044OH.

*Doors only, you must order rails.

**Requires (1) PL44RAIL per (2) PL44SLIDESGD.



OPTIONAL HUTCH LOCK
Hutch Door Lock
PLLDLOCKKIT
 List: \$59.00 ea.
 Available in BK Black or SI Silver



Optional Sliding Glass Doors - OS127 Typical
 Complements Well With NEW! American Elm Finish & Optional Black Pulls



Optional Laminate Doors - OS269 Typical
 Complements Well With NEW! American Elm Finish & Silver Pulls



NEW! AE American Elm CG Coastal Gray ES Espresso MW Modern Walnut MH Mahogany CH Cherry WH White MA Maple
 (†Select SKUs)

Note: American Elm only available for select SKUs. Select SKUs are notated by a † mark at the end of their SKU.



OS LAMINATE

Pictured w/Bradley & Tre Seating & OS21 Typical

A Storage Cabinet

PL113†
35½"W x 22"D x 29½"H
List: \$726.00

PL152†
35½"W x 22"D x 37¼"H
List: \$1,050.00

PL151†
35½"W x 22"D x 65½"H
List: \$1,733.00

B 2 Drawer Lateral File

PL112†
35½"W x 22"D x 29½"H
List: \$1,248.00

C Credenza Top

PL110†
71"W x 22"D x 1"H
List: \$325.00

PL110 sits on top of/can be applied to (2) PL112, (2) PL172, PL113, PL1012, PL2013 or PL152.

D Tempered Glass Silver Framed Cabinet Doors

PL152SGD (Set of 2 - For PL152)
List: \$737.00

PL113SGD (Set of 2 - For PL113)
List: \$432.00

Available in FR Frosted Glass

Some items in this collection come ready-to-assemble.

Casters Hidden Behind Laminate (For PL148 & PL149)

E Deluxe Full Pedestal

PL166† (Box/Box/File)
15½"W x 22"D x 28½"H
List: \$696.00

Deluxe Full Pedestal PL175† (File/File)
15½"W x 22"D x 28½"H
List: \$714.00

Top Panel

PL66†† (For PL166 & PL175)
16"W x 22"D x 1"H
List: \$110.00

ADDITIONAL PRODUCTS



Combo Lateral File

PL114† (Box/Box/File w/Drawer)
31"W x 22"D x 29½"H \$1,409.00

Buffet Credenza (Top Drawer & Doors)

PL172†
35½"W x 22"D x 37¾"H \$1,696.00

Wardrobe Unit (2 Drawer & Coat Rod)

PL207†
24¼"W x 23¾"D x 65½"H \$2,507.00

Personal Unit (4 Adj. Shelves & Coat Rod)

PL150
17¾"W x 23¾"D x 65½"H \$1,329.00



3 Drawer Lateral File

PL183†
35½"W x 22"D x 42"H \$2,948.00

4 Drawer Lateral File

PL184†
35½"W x 22"D x 54½"H \$3,612.00

31½"W Bookcases

PL154† 14"D x 29½"H \$359.00
PL155† 14"D x 47¼"H \$472.00
PL156† 14"D x 71"H \$670.00

Optional Door Kit (For Bookcases)

PLBCDK† 16"W x ¾"D x 26"H \$253.00



Mobile Pedestals

PL148† (Box/Box/File)
16"W x 22½"D x 28½"H \$946.00

PL149 (File/File)
16"W x 22½"D x 28½"H \$988.00

PL1007† (Box/File)
16"W x 22½"D x 22½"H \$769.00

Optional Top Cushion

CUSH2136 (For PL112 & PL113) \$445.00
CUSH1623 (For PL1007) \$237.00

Tempered Glass Silver Framed

Cabinet Doors (For PL150 & PL151)
PL150151SGD (1) Per Box \$450.00



¾" Hanging Pedestals

PL107† (Box/File)
15½"W x 22"D x 19"H \$501.00

PL108† (Box/File)
15½"W x 19"D x 19"H \$501.00

(For use with PL146 & PL198)

Corner Bookcases

PL161 15"W x 36"H \$519.00
PL160 24"W x 29½"H \$716.00

Note: PL161 & PL160 are not available in MA Maple or WH White.

Note: PL150151SGD - (1) Per Box, Order (2) for complete coverage on PL151.

OPTIONAL CORES & KEYS



Lock Core Kit (Set of 2)
PLLOCKCOREKIT
List: \$50.00

Note: Please ask your Sales Rep about keying-alike or differently for PLLOCKCOREKIT.

Note: PLMKEY, PLLOCKCOREKIT & PLKEYBLANK can be shipped by a small package carrier. 📦



Master Key
PLMKEY
List: \$31.00



Blank Key (Set of 2)
PLKEYBLANK
List: \$29.00

C



Shown w/PL110 on top of (2) PL172

OS LAMINATE

DESK PACKAGES

Single Pedestal Desk Packages

- 3/4 Pedestal, (1) PL107



SGLHDPL104†	48"W x 24"D	\$998.00
SGLHDPL121†	48"W x 30"D	\$1,034.00
SGLHDPL103†	60"W x 30"D	\$1,042.00
SGLHDPL102†	66"W x 30"D	\$1,086.00
SGLHDPL105†	71"W x 30"D	\$1,227.00
SGLHDPL101†	71"W x 36"D	\$1,240.00

Single Pedestal "L" Desk Packages

- 24" x 47" Return, (1) PL145
- 3/4 Pedestal, (1) PL107



SGLHLPL103†	60"W x 30"D	\$1,543.00
SGLHLPL102†	66"W x 30"D	\$1,587.00
SGLHLPL105†	71"W x 30"D	\$1,728.00
SGLHLPL101†	71"W x 36"D	\$1,741.00

Double Pedestal Desk Packages

- 3/4 Pedestal, (2) PL107



DBLHDPL103†	60"W x 30"D	\$1,543.00
DBLHDPL102†	66"W x 30"D	\$1,587.00
DBLHDPL105†	71"W x 30"D	\$1,728.00
DBLHDPL101†	71"W x 36"D	\$1,741.00

Double Pedestal "L" Desk Packages

- 24" x 47" Return, (1) PL145
- 3/4 Pedestal, (2) PL107



DBLHLPL103†	60"W x 30"D	\$2,044.00
DBLHLPL102†	66"W x 30"D	\$2,088.00
DBLHLPL105†	71"W x 30"D	\$2,229.00
DBLHLPL101†	71"W x 36"D	\$2,242.00

Double Pedestal Desk Packages

- Full Pedestal, (1) PL166, (1) PL175



DBLFDPL103†	60"W x 30"D	\$1,951.00
DBLFDPL102†	66"W x 30"D	\$1,995.00
DBLFDPL105†	71"W x 30"D	\$2,136.00
DBLFDPL101†	71"W x 36"D	\$2,149.00

Double Pedestal "L" Desk Packages

- 24" x 47" Return, (1) PL145
- Full Pedestal, (1) PL166, (1) PL175



DBLFLPL103†	60"W x 30"D	\$2,452.00
DBLFLPL102†	66"W x 30"D	\$2,496.00
DBLFLPL105†	71"W x 30"D	\$2,637.00
DBLFLPL101†	71"W x 36"D	\$2,650.00

Note: OS Laminate finishes come standard with standard pulls. Additional optional pulls are available separately - See Page 35.

"L" & "U" CONFIGURATIONS W/HUTCH



*Pictured w/Optional
PL118 Tack Board*

**Desk w/Corner Extension, Return
& Open Hutch**
OS208†
Includes: PL182R†/PL166†/PL179†/PL144OH†
71"W x 66"D x 65½"H
List: \$2,765.00



*Pictured w/Optional
PL118 Tack Board*

**Desk w/Corner Extension, Return
& Hutch w/Laminate Doors**
OS209†
Includes: PL182R†/PL166†/PL179†/PL144OH†/PL44LD†
71"W x 66"D x 65½"H
List: \$2,848.00



*Pictured w/Optional
PL118 Tack Board*

**Desk w/Corner Extension, Return
& Hutch w/Glass Doors**
OS210†
Includes: PL182R†/PL166†/PL179†/PL144OH†/PL44SGD
71"W x 66"D x 65½"H
List: \$3,138.00



OS211†

**Bow Front Desk, Bridge, Credenza
w/Corner Extension & Open Hutch**
OS211†
Includes: PL189†/PL182R†/PL166†/PL193†/PL144OH†
71"W x 107½"D x 65½"H
List: \$3,696.00



*Pictured w/Optional
PL118 Tack Board*

**Bow Front Desk, Bridge, Credenza
w/Corner Extension & Hutch w/Glass Doors**
OS212†
Includes: PL189†/PL182R†/PL166†/PL193†/PL144OH†/PL44SGD
71"W x 107½"D x 65½"H
List: \$4,069.00



NEW! AE American Elm
(†Select SKUs)



CG Coastal Gray



ES Espresso



MW Modern Walnut



MH Mahogany



CH Cherry



WH White



MA Maple

Note: American Elm **only** available for select SKUs. Select SKUs are notated by a † mark at the end of their SKU.



OS LAMINATE
Coastal Gray Finish

Multi-Person Typical
OS148†
Total List: \$9,952.00
142"W x 144"D x 40½"H
Excludes Seating & Accessories
Pictured w/Oslo Seating



OS22V | Components

SKU #	QTY	DESCRIPTION	W x D x H
PL489†	1	Bow Top w/Modesty	71 x 36/41 x 29½
PL71SGM	1	Glass Modesty Panel	40 x 1¼ x 28
PL46836†	2	False Pedestal	15¾ x 35½ x 28½
PL170†	1	Bridge	47 x 24 x 29½
PL143†	1	Credenza Shell	71 x 24 x 29½
PL166†	2	Deluxe Full Pedestal - B/B/F	15½ x 22 x 28½
PL144OH†	1	Open Hutch	71 x 15 x 36
PL44SGD	1	Silver Frame Glass Doors	17 x ¾ x 15¾
PL118	1	Tack Board (Visconti Fabric)	68% x ½ x 16½
PL112†	1	Two Drawer Lateral File	35½ x 22 x 29½
PL153†	1	Open Hutch	35½ x 14 x 36

U Shape Typical
OS22V†

Total List: \$8,264.00
112"W x 106½"D x 65½"H
Excludes Accessories
Stocked in AE, CG & ES Only

OS22V available in **NEW! AE American Elm**,
ES Espresso & CG Coastal Gray Only.

OS148 | Components

SKU #	QTY	DESCRIPTION	W x D x H
PL169NTT†	4	Reception Desk Shell	71 x 30 x 40½
PL180†	4	Reception Reversible Return	42 x 24 x 40½
PL107†	8	Hanging 3/4 Pedestal - B/F	15½ x 22 x 19

Standard Pull Options

Customize Your Pull Options - See Page 35



NEW! AE American Elm w/Silver Pulls
(†Select SKUs)

CG Coastal Gray w/Silver Pulls

ES Espresso w/Silver Pulls



MW Modern Walnut w/Silver Pulls

MH Mahogany w/Black Pulls

CH Cherry w/Black Pulls



WH White w/Silver Pulls

MA Maple w/Black Pulls

Note: American Elm **only** available for select SKUs. Select SKUs are notated by a † mark at the end of their SKU.



OS LAMINATE
Coastal Gray Finish

U Shape Typical
OS19V†
Total List: \$9,851.00
142"W x 107"D x 65½"H
Excludes Seating & Accessories
Pictured w/Veneto Seating



NEW! OSTYP318 | Components

SKU #	QTY	DESCRIPTION	W x D x H
PL134	1	Corner Desk Shell	42 x 42 x 29½
PL179†	2	Reversible Return	30 x 24 x 29½
PL107†	2	Hanging 3/4 Pedestal - B/F	15½ x 22 x 19

OSTYP318 available in CH Cherry, MH Mahogany, ES Espresso, MW Modern Walnut & CG Coastal Gray Only.

OSTYP318 is **not available** in AE American Elm.

NEW! L Shape Typical
OSTYP318

Total List: \$2,496.00
72"W x 72"D x 29½"H
Excludes Accessories

OS19V | Components

SKU #	QTY	DESCRIPTION	W x D x H
PL189†	1	Bow Front Desk Shell	71 x 36/41 x 29½
PL197†	1	Bridge	42 x 24 x 29½
PL143†	1	Credenza Shell	71 x 24 x 29½
PL166†	2	Deluxe Full Pedestal - B/B/F	15½ x 22 x 28½
PL152†	2	Storage Cabinet	35½ x 22 x 37¼
PL112†	2	2 Drawer Lateral File	35½ x 22 x 29½
PL144OH†	1	Open Hutch	71 x 15 x 36
PL44SGD	2	Silver Frame Glass Doors (Set of 2)	17 x ¾ x 15¾
PL118	1	Tack Board (Visconti Fabric)	68% x ½ x 16½

Additional Pull Options

Customize Your Pull Options - See Page 35



Rectangular Pull
Silver Only

Modern Bar Pull
Silver

Modern Bar Pull
Black



Modern Metro Pull
Silver

Modern Metro Pull
Black

Modern Metro Pull
Gray



Mid-Century Pull
Silver

Mid-Century Pull
Black

Mid-Century Pull
Gray

Note: American Elm **only** available for select SKUs. Select SKUs are notated by a † mark at the end of their SKU.



OS LAMINATE
Coastal Gray Finish

**L Shape Typical
OS266**

Total List: \$2,328.00

71"W x 72"D x 29½"H

Excludes Seating & Accessories

Pictured w/CoolMesh & Chelsea Seating
& Optional Tempered Glass Chair Mat



NEW! OSTYP308 | Components

SKU #	QTY	DESCRIPTION	W x D x H
PL178L†	1	Desk w/Corner Extension - Lt	71 x 23¼/42 x 29½
PL179†	1	Reversible Return	30 x 24 x 29½
PL166†	1	Deluxe Full Pedestal - B/B/F	15½ x 22 x 28½
PL208OH†	1	Wall Mount - Open Hutch	36½ x 15 x 17
PL44SGD	1	Silver Frame Glass Doors (Set of 2)	17 x ¾ x 15¾

**NEW! L Shape Typical
OSTYP308†**

Total List: \$3,164.00

71"W x 72"D x 65½"H

Excludes Seating & Accessories

Pictured w/Cade Seating

OS266 | Components

SKU #	QTY	DESCRIPTION	W x D x H
PLT147T/PLTEP36/PL142	1	Bullet Top Unit*	72 x 36 x 29½
PL192†	1	Reversible Return	35 x 24 x 29½
PL166†	1	Deluxe Full Pedestal - B/B/F	15½ x 22 x 28½
OS720	1	Silver Post Leg	3"Dia x 28½

*Bullet Top Unit - All (3) SKUs must be ordered together (top + end panel + half gable/leg).

OS266 available in *ES Espresso*, *MA Maple*, *MW Modern Walnut* & *CG Coastal Gray* Only.

Standard Pull Options

Customize Your Pull Options - See Page 35



NEW! AE American Elm w/Silver Pulls
(†Select SKUs)

CG Coastal Gray w/Silver Pulls

ES Espresso w/Silver Pulls



MW Modern Walnut w/Silver Pulls

MH Mahogany w/Black Pulls

CH Cherry w/Black Pulls



WH White w/Silver Pulls

MA Maple w/Black Pulls

Note: American Elm **only** available for select SKUs. Select SKUs are notated by a † mark at the end of their SKU.



OS LAMINATE
Espresso Finish

L Shape Typical
OS112
Total List: \$4,102.00
71"W x 95"D x 29½"H
Excludes Seating & Accessories
Pictured w/CoolMesh Seating



NEW! OSTYP322 | Components

SKU #	QTY	DESCRIPTION	W x D x H
PL189†	1	Bow Front Desk Shell	71 x 36/41 x 29½
PL193†	1	Bridge	35 x 24 x 29½
PL143†	1	Credenza Shell	71 x 24 x 29½
PL112†	1	2 Drawer Lateral File	35½ x 22 x 29½
PL144OH†	1	Open Hutch	71 x 15 x 36
PL44SGD	2	Silver Frame Glass Doors (Set of 2)	17 x ¾ x 15¾
PL118	1	Tack Board (Gray Fabric)	68% x ½ x 16½

NEW! U Shape Typical
OSTYP322†
Total List: \$5,087.00
71"W x 107"D x 65½"H
Excludes Seating & Accessories
Pictured w/Cade Seating

OSTYP322 available in **NEW! AE American Elm, CH Cherry, ES Espresso, MH Mahogany, MW Modern Walnut, CG Coastal Gray & WH White Only.**

OS112 | Components

SKU #	QTY	DESCRIPTION	W x D x H
PL177R	1	Desk w/Corner Extension - Rt	71 x 30/36/42/48 x 29½
PL145†	1	Reversible Return - Rt	47 x 24 x 29½
PL166†	1	Deluxe Full Pedestal - B/B/F	15½ x 22 x 28½
PL114†	1	Combo Lateral File - B/B/F/Lat.	31 x 22 x 29½
OSPULLRSI	7	Rectangular Pulls	7 x 1 x 1

Note: Typical sold with optional pulls - See Page 35 for standard pulls.

OS112 available in **CH Cherry, ES Espresso, MH Mahogany, MW Modern Walnut, CG Coastal Gray & WH White Only.**

Additional Pull Options

Customize Your Pull Options - See Page 35



Rectangular Pull
Silver Only



Modern Bar Pull
Silver



Modern Bar Pull
Black



Modern Metro Pull
Silver



Modern Metro Pull
Black



Modern Metro Pull
Gray



Mid-Century Pull
Silver



Mid-Century Pull
Black



Mid-Century Pull
Gray

Note: American Elm **only** available for select SKUs. Select SKUs are notated by a † mark at the end of their SKU.

OS LAMINATE
Espresso Finish



NEW! L Shape Typical OSTYP309†
Total List: \$2,229.00
71"W x 72"D x 65½"H
Excludes Seating & Accessories
Pictured w/CoolMesh Seating



NEW! OSTYP309 | Components

SKU #	QTY	DESCRIPTION	W x D x H
PL178L†	1	Desk w/Corner Extension - Lt	71 x 23¼/42 x 29½
PL179†	1	Reversible Return	30 x 24 x 29½
PL166†	1	Deluxe Full Pedestal - B/B/F	15½ x 22 x 28½

Standard Pull Options
Customize Your Pull Options - See Page 35



NEW! OSTYP328 | Components

SKU #	QTY	DESCRIPTION	W x D x H
PL489†	1	Bow Top w/Modesty	71 x 36/41 x 29½
PL46836†	2	False Pedestal	15¾ x 35½ x 28½
PL715GM	1	Glass Modesty Panel	40 x 1¼ x 28
PL170†	1	Bridge	47 x 24 x 29½
PL143†	1	Credenza Shell	71 x 24 x 29½
PL166†	1	Deluxe Full Pedestal - B/B/F	15½ x 22 x 28½
PL144OH†	1	Open Hutch	71 x 15 x 36
PL112†	1	Two Drawer Lateral File	35½ x 22 x 29½
PL445GD	1	Silver Frame Glass Doors	17 x ¾ x 15¾
PL152†	1	Storage Cabinet	35½ x 22 x 37¼
PL152SGD	1	Silver Frame Glass Cabinet Doors	17½ x ½ x 36¼
GBM1769	1	Magnetic Glass White Board	68½ x ½ x 16½

NEW! U Shape Typical OSTYP328†
Total List: \$8,833.00
112"W x 107"D x 65½"H
Excludes Accessories
Pictured w/CoolMesh Seating
Stocked in AE, CG & ES Only

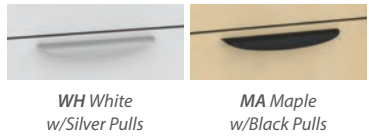

Note: American Elm only available for select SKUs. Select SKUs are notated by a † mark at the end of their SKU.

OSTYP328 available in NEW! AE American Elm, ES Espresso & CG Coastal Gray Only.



OS LAMINATE
Espresso Finish

NEW! U Shape Typical
OSTYP316
Total List: \$4,844.00
72"W x 108"D x 65½"H
Excludes Seating & Accessories
Pictured w/CoolMesh Pro Seating



OS24 | Components

SKU #	QTY	DESCRIPTION	W x D x H
PL181R†	1	Credenza w/Corner Ext - Rt	66 x 24/36 x 29½
PL179†	1	Reversible Return	30 x 24 x 29½
PL166†	1	Deluxe Full Pedestal - B/B/F	15½ x 22 x 28½
PL140OH†	1	Open Hutch	66 x 15 x 36
PL40SGD	1	Silver Frame Glass Doors	18 x ½ x 15¾
PL117	1	Tack Board (Visconti Fabric)	64 x ½ x 16½
PL207†	1	Wardrobe Unit	24¼ x 23¾ x 65½

L Shape Typical
OS24†
Total List: \$5,940.00
90¼"W x 66"D x 65½"H
Excludes Accessories

Note: American Elm **only** available for select SKUs.
Select SKUs are notated by a † mark at the end of their SKU.

NEW! OSTYP316 | Components

SKU #	QTY	DESCRIPTION	W x D x H
PL143†	1	Credenza Shell	71 x 24 x 29½
PLTULEG30	2	Unite Leg	29½ x 1½ x 28½
PLTCBBSINGLE	2	Connector Beam Bracket	
PLTADJMDB4872	1	Top Support Beam	67¾ x 2 x 1
PLT2436†	1	Return Top	36 x 24 x 1
PLT3072†	1	Rectangular Top	72 x 30 x 1
PL166†	1	Deluxe Full Pedestal - B/B/F	15½ x 22 x 28½
PL144OH†	1	Open Hutch	71 x 15 x 36
PL44LD†	1	Laminate Hutch Doors (Set of 2)	17 x ¾ x 15¾
GBM1769	1	Magnetic Glass White Board	68½ x ½ x 16½
PLTFB	4	Flat Brackets	
PLTLMP66	1	Laminate Modesty Panel	66 x ¾ x 18

OSTYP316 is **not available** in AE American Elm.

Additional Pull Options

Customize Your Pull Options - See Page 35



Rectangular Pull
Silver Only



Modern Bar Pull
Silver



Modern Bar Pull
Black



Modern Metro Pull
Silver



Modern Metro Pull
Black



Modern Metro Pull
Gray



Mid-Century Pull
Silver



Mid-Century Pull
Black



Mid-Century Pull
Gray



OS LAMINATE
Modern Walnut Finish

Two-Person Typical OS170
Total List: \$6,379.00
96"W x 226"D x 29½"H
Excludes Seating & Accessories
Pictured w/Cade Seating



NEW! OSTYP317 | Components

SKU #	QTY	DESCRIPTION	W x D x H
PLT4172†	4	Standing Table	72 x 30 x 41¾

OSTYP317 available in **NEW! AE American Elm**, **ES Espresso**, **MW Modern Walnut**, **CG Coastal Gray** & **WH White** Only.

Note: American Elm only available for select SKUs. Select SKUs are notated by a † mark at the end of their SKU.

OS170 | Components

SKU #	QTY	DESCRIPTION	W x D x H
PL178L†	1	Desk w/Corner Extension - Lt	71 x 23¼/42 x 29½
PL178R†	1	Desk w/Corner Extension - Rt	71 x 23¼/42 x 29½
PL143†	2	Credenza Shell	71 x 24 x 29½
PL142†	4	Half Legs	12¾ x 1 x 28
PL166†	2	Deluxe Full Pedestal - B/B/F	15½ x 22 x 28½
PLT147T	1	Bullet Top	72 x 36 x 1
OS720	1	Silver Post Leg	3"Dia x 28½
PLT72MSBK	1	Stiffener Support (Set of 2)	60¼ x 2¼ x 1
PLTFB	3	Flat Brackets	

OS170 available in **CG Coastal Gray**, **ES Espresso**, **MA Maple** & **MW Modern Walnut** Only.

Standard Pull Options

Customize Your Pull Options - See Page 35



NEW! AE American Elm w/Silver Pulls
(†Select SKUs)

CG Coastal Gray w/Silver Pulls

ES Espresso w/Silver Pulls



MW Modern Walnut w/Silver Pulls

MH Mahogany w/Black Pulls

CH Cherry w/Black Pulls



WH White w/Silver Pulls

MA Maple w/Black Pulls

NEW! Multi-Person Typical OSTYP317†

Total List: \$5,064.00
144"W x 60"D x 41"H
Excludes Accessories



OS LAMINATE
Modern Walnut Finish

**NEW! Four-Person Typical
(2) OS170**
Total List: \$12,758.00
96"W x 226"D x 29½"H
*Based on (2) OS170 put together
Excludes Seating & Accessories
Pictured w/Cade Seating



OS154 | Components

SKU #	QTY	DESCRIPTION	W x D x H
PL143†	1	Credenza Shell	71 x 24 x 29½
PL114†	1	Combo Lateral File - B/B/F/Lat.	31 x 22 x 29½
PL207†	1	Wardrobe Storage Unit	24¼ x 23¾ x 65½
PL144OHT	1	Open Hutch	71 x 15 x 36
PL44SGD	1	Silver Frame Glass Doors	17 x ¾ x 15¾
GBM1769	1	Magnetic Glass White Board	68½ x ½ x 16½

**Simple Desk Typical
OS154†**
Total List: \$6,178.00
95¼"W x 24"D x 65½"H
Excludes Accessories

Note: American Elm **only** available for select SKUs.
Select SKUs are notated by a † mark at the end of their SKU.

NEW! (2) OS170 | Components

SKU #	QTY	DESCRIPTION	W x D x H
PL178L†	2	Desk w/Corner Extension - Lt	71 x 23¼/42 x 29½
PL178R†	2	Desk w/Corner Extension - Rt	71 x 23¼/42 x 29½
PL143†	4	Credenza Shell	71 x 24 x 29½
PL142†	8	Half Legs	12¾ x 1 x 28
PL166†	4	Deluxe Full Pedestal - B/B/F	15½ x 22 x 28½
PLT147T	2	Bullet Top	72 x 36 x 1
OS720	2	Silver Post Leg	3"Dia x 28½
PLT72MSBK	2	Stiffener Support (Set of 2)	60¼ x 2¼ x 1
PLTFB	6	Flat Brackets	

(2) OS170 available in CG Coastal Gray, ES Espresso, MA Maple & MW Modern Walnut Only.

Note: This typical is based on (2) OS170 put together to form a four-person workstation.

Additional Pull Options

Customize Your Pull Options - See Page 35





OS LAMINATE
Modern Walnut Finish

U Shape Typical OS239

Total List: \$4,386.00
72"W x 102"D x 65½"H
Excludes Seating, Bookcases & Accessories
Pictured w/Tre & Big & Tall Seating & Optional Tempered Glass Chair Mat



OS31 | Components

SKU #	QTY	DESCRIPTION	W x D x H
PL182R†	1	Credenza w/Corner Ext. - Rt	71 x 24/36 x 29½
PL192†	1	Reversible Return	35 x 24 x 29½
PL166†	1	Deluxe Full Pedestal - B/B/F	15½ x 22 x 28½
PL208OH†	1	Wall Mount - Open Hutch	36½ x 15 x 17
PL44LD†	1	Laminate Door (Sets of 2)	17 x ¾ x 15¾

L Shape Typical OS31†

Total List: \$2,577.00
71"W x 71"D x 29½"H
Excludes Seating & Accessories
Pictured w/CoolMesh Seating

*Height does not include wall mounted hutches.

Note: American Elm only available for select SKUs.
Select SKUs are notated by a † mark at the end of their SKU.

OS239 | Components

SKU #	QTY	DESCRIPTION	W x D x H
PLT147T/PLTEP36/PL142	1	Bullet Top Unit*	72 x 36 x 29½
OS720	1	Post Leg	3"Dia x 28½"
PL197†	1	Bridge	42 x 24 x 29½
PL143†	1	Credenza Shell	71 x 24 x 29½
PL107†	1	Hanging 3/4 Pedestal - B/F	15½ x 22 x 19
PL144OH†	1	Open Hutch	71 x 15 x 36
PL44SGD	1	Silver Frame Glass Doors	17 x ¾ x 15¾
GBM1769	1	Magnetic Glass White Board	68½ x ½ x 16½

*Bullet Top Unit - All (3) SKUs must be ordered together (top + end panel + half gable/leg).

OS239 available in *ES Espresso*, *MA Maple*, *MW Modern Walnut* & *CG Coastal Gray* Only.

Standard Pull Options

Customize Your Pull Options - See Page 35



NEW! AE American Elm w/Silver Pulls
(†Select SKUs)

CG Coastal Gray w/Silver Pulls

ES Espresso w/Silver Pulls



MW Modern Walnut w/Silver Pulls

MH Mahogany w/Black Pulls

CH Cherry w/Black Pulls



WH White w/Silver Pulls

MA Maple w/Black Pulls



OS LAMINATE
Mahogany Finish

U Shape Typical
OS88†
Total List: \$4,514.00
71"W x 112"D x 65½"H
Excludes Seating & Accessories
Pictured w/Tre Seating



OS89 | Components

SKU #	QTY	DESCRIPTION	W x D x H
PL101†	1	Desk Shell	71 x 35½ x 29½
PL145†	1	Reversible Return (Rt)	47 x 24 x 29½
PL166†	1	Deluxe Full Pedestal - B/B/F	15½ x 22 x 28½
PL175†	1	Deluxe Full Pedestal - F/F	15½ x 22 x 28½
PL144OH†	1	Open Hutch	71 x 15 x 36
PL44SGD	1	Silver Frame Glass Doors	17 x ¾ x 15¾
PL118	1	Tack Board (Visconti Fabric)	68½ x ½ x 16½

L Shape Typical
OS89†
Total List: \$4,233.00
71"W x 83"D x 65½"H
Excludes Accessories

OS88 | Components

SKU #	QTY	DESCRIPTION	W x D x H
PL189†	1	Bow Front Desk Shell	71 x 36/41 x 29½
PL193†	1	Bridge	35 x 24 x 29½
PL182R†	1	Credenza w/Corner Ext (Rt)	71 x 24/36 x 29½
PL166†	1	Deluxe Full Pedestal - B/B/F	15½ x 22 x 28½
PL144OH†	1	Open Hutch	71 x 15 x 36
PL44SGD	1	Silver Frame Glass Doors	17 x ¾ x 15¾
GBM1769	1	Magnetic Glass White Board	68½ x ½ x 16½

Additional Pull Options

Customize Your Pull Options - See Page 35



Rectangular Pull
Silver Only



Modern Bar Pull
Silver



Modern Bar Pull
Black



Modern Metro Pull
Silver



Modern Metro Pull
Black



Modern Metro Pull
Gray



Mid-Century Pull
Silver



Mid-Century Pull
Black



Mid-Century Pull
Gray

Note: American Elm **only** available for select SKUs. Select SKUs are notated by a † mark at the end of their SKU.



OS LAMINATE
Mahogany Finish

NEW! U Shape Typical
OSTYP329
Total List: \$7,610.00
94¾"W x 107"D x 65½"H
Excludes Seating & Accessories
Pictured w/CoolMesh Seating &
Optional Tempered Glass Chair Mat



OS263 | Components

SKU #	QTY	DESCRIPTION	W x D x H
PL187†	1	Bow Front Desk Shell	66 x 30/35½ x 29½
PL166†	1	Deluxe Full Pedestal - B/B/F	15½ x 22 x 28½
PL170†	1	Bridge	47 x 24 x 29½
PL111†	1	Credenza Shell	66 x 24 x 29½

Note: American Elm only available for select SKUs.
Select SKUs are notated by a † mark at the end of their SKU.

NEW! OSTYP329 | Components

SKU #	QTY	DESCRIPTION	W x D x H
PL207†	1	Wardrobe Unit	24¼ x 23¾ x 65½
PL143†	1	Credenza Shell	71 x 24 x 29½
PL114†	1	Combo Lateral File - B/B/F/Lat.	31 x 22 x 29½
PL144OH†	1	Open Hutch	71 x 15 x 36
PL118	1	Tack Board (Gray Fabric)	68% x ½ x 16½
PL193†	1	Bridge	35 x 24 x 29½
PL177L	1	Desk w/Corner Extension (Lt)	71 x 30/36/42/48 x 29½
PL44SGD	1	Silver Frame Glass Doors	17 x ¾ x 15¾

OSTYP329 available in **CH Cherry**, **ES Espresso**, **MH Mahogany**, **MW Modern Walnut**, **CG Coastal Gray** & **WH White** Only.

Standard Pull Options

Customize Your Pull Options - See Page 35



NEW! AE American Elm w/Silver Pulls
(†Select SKUs)

CG Coastal Gray w/Silver Pulls

ES Espresso w/Silver Pulls



MW Modern Walnut w/Silver Pulls

MH Mahogany w/Black Pulls

CH Cherry w/Black Pulls

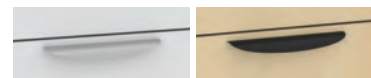

WH White w/Silver Pulls

MA Maple w/Black Pulls

U Shape Typical

OS263†
Total List: \$2,615.00
66"W x 106½"D x 29½"H
Excludes Seating & Accessories
Pictured w/Charleston & Ebony Seating



OS LAMINATE
Mahogany Finish

U Shape Typical
OS245†
Total List: \$4,221.00
71"W x 112"D x 65½"H
Excludes Accessories



OS238 | Components

SKU #	QTY	DESCRIPTION	W x D x H
PL177L	1	Desk w/Corner Extension (Lt)	71 x 30/36/42/48 x 29½
PL193†	1	Bridge	35 x 24 x 29½
PL143†	1	Credenza Shell	71 x 24 x 29½
PL166†	1	Deluxe Full Pedestal - B/B/F	15½ x 22 x 28½
PL144OH†	1	Open Hutch	71 x 15 x 36
PL44SGD	2	Silver Frame Glass Doors	17 x ¾ x 15¾
PL118	1	Tack Board (Gray Fabric)	68% x ½ x 16½
PL161	1	Corner Bookcase	15 x 15 x 36
PL160	1	Corner Bookcase	24 x 24 x 29½

U Shape Typical
OS238
Total List: \$5,998.00
95"W x 107"D x 65½"H
Excludes Accessories

OS238 available in CH Cherry, ES Espresso, MH Mahogany, MW Modern Walnut & CG Coastal Gray Only.

OS245 | Components

SKU #	QTY	DESCRIPTION	W x D x H
PL189†	1	Bow Front Desk Shell	71 x 36/41 x 29½
PL193†	1	Bridge	35 x 24 x 29½
PL182R†	1	Credenza w/Corner Ext (Rt)	71 x 24/36 x 29½
PL166†	1	Deluxe Full Pedestal - B/B/F	15½ x 22 x 28½
PL144OH†	1	Open Hutch	71 x 15 x 36
PL44LD†	2	Laminate Doors (Sets of 2)	17 x ¾ x 15¾
PL118	1	Tack Board (Gray Fabric)	68% x ½ x 16½

Additional Pull Options

Customize Your Pull Options - See Page 35



Note: American Elm only available for select SKUs. Select SKUs are notated by a † mark at the end of their SKU.



OS LAMINATE
Cherry Finish

**Multi-Person Typical
OS200†**
Total List: \$4,248.00
213"W x 30"D x 40½"H
Excludes Seating & Accessories
Pictured w/Advanced Seating



OS246 | Components

SKU #	QTY	DESCRIPTION	W x D x H
PL182R†	1	Credenza w/Corner Ext (Rt)	71 x 24/36 x 29½
PL192†	1	Reversible Return	35 x 24 x 29½
PL144OH†	1	Open Hutch	71 x 15 x 36
PL44SGD	1	Silver Frame Glass Doors	17 x ¾ x 15¾
PL118	1	Tack Board (Gray Fabric)	68% ₁₆ x ½ x 16½
PL166†	1	Deluxe Full Pedestal - B/B/F	15½ x 22 x 28½

**L Shape Typical
OS246†**
Total List: \$3,515.00
71"W x 71"D x 65½"H
Excludes Seating & Accessories
Pictured w/Advanced Seating

OS200 | Components

SKU #	QTY	DESCRIPTION	W x D x H
PL169NTT†	3	Reception Desk Shell	71 x 30 x 40½
PL107†	3	Hanging 3/4 Pedestal - B/F	15½ x 22 x 19

Standard Pull Options
Customize Your Pull Options - See Page 35



NEW! AE American Elm w/Silver Pulls
(†Select SKUs)

CG Coastal Gray w/Silver Pulls

ES Espresso w/Silver Pulls



MW Modern Walnut w/Silver Pulls

MH Mahogany w/Black Pulls

CH Cherry w/Black Pulls

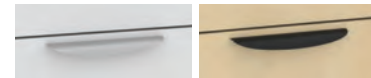

WH White w/Silver Pulls

MA Maple w/Black Pulls

Note: American Elm **only** available for select SKUs. Select SKUs are notated by a † mark at the end of their SKU.



OS LAMINATE
Cherry Finish

Executive Typical
OS74
Total List: \$11,140.00
107"W x 65½"H
*Depth will depend on space left for chair
Excludes Seating & Accessories
Pictured w/Bradley & Dover Seating



OS74 | Components

SKU #	QTY	DESCRIPTION	W x D x H
PL189†	1	Bow Front Desk Shell	71 x 36/41 x 29½
PL166†	2	Deluxe Full Pedestal - B/B/F	15½ x 22 x 28½
PL150	2	Personal Storage Cabinet	17¾ x 23¾ x 65½
PL150151SGD	2	Glass Storage Cabinet Doors	18 x ½ x 65½
PL113†	2	Storage Cabinet - 29½"H	35½ x 22 x 29½
PL113SGD	2	Glass Storage Cabinet Doors	17¾ x ½ x 29½
PL110†	1	Top (To Create Credenza)	71 x 22 x 1
PL2044OH†	1	Wall Mount - Open Hutch	71 x 15 x 17
PL44SGD	2	Silver Frame Glass Doors	17 x ¾ x 15¾
PL118	1	Tack Board (Gray Fabric)	68% ₁₀ x ½ x 16½
OSPULLHLSI	12	Silver Crescent Pulls	7 x 1 x 1

Note: Typical sold with optional pulls - See Page 35 for standard pulls.

OS74 is **not available** in AE American Elm.

Additional Pull Options

Customize Your Pull Options - See Page 35



Rectangular Pull
Silver Only



Modern Bar Pull
Silver



Modern Bar Pull
Black



Modern Metro Pull
Silver



Modern Metro Pull
Black



Modern Metro Pull
Gray



Mid-Century Pull
Silver



Mid-Century Pull
Black



Mid-Century Pull
Gray

OS265 | Components

SKU #	QTY	DESCRIPTION	W x D x H
PL2044OH†	2	Wall Mount - Open Hutch	71 x 15 x 17
PL44LD†	4	Laminate Doors (Sets of 2)	17 x ¾ x 15¾
PL182L†	2	Credenza w/Corner Ext.	71 x 24/36 x 29½
PL192†	2	Reversible Return	35 x 24 x 29½
PL166†	2	Deluxe Full Pedestal - B/B/F	15½ x 22 x 28½

Multi-Person Typical
OS265†

Total List: \$6,088.00
142"W x 71"D x 29½"H
Excludes Seating & Accessories
Pictured w/Advanced Seating

Note: American Elm **only** available for select SKUs.
Select SKUs are notated by a † mark at the end of their SKU.



OS LAMINATE
Maple Finish

L Shape Typical
OS127†
Total List: \$4,522.00
71"W x 83"D x 65½"H
Excludes Seating & Accessories
Pictured w/Advanced Seating



OS56 | Components

SKU #	QTY	DESCRIPTION	W x D x H
PL101†	1	Desk Shell	71 x 35½ x 29½
PL170†	1	Bridge	47 x 24 x 29½
PL143†	1	Credenza Shell	71 x 24 x 29½
PL112†	1	2 Drawer Lateral File	35½ x 22 x 29½
PL144OH†	1	Open Hutch	71 x 15 x 36
PL44LD†	2	Laminate Hutch Doors (Set of 2)	17 x ¾ x 15¾
PL118	1	Tack Board (Gray Fabric)	68% ₁₀ x ½ x 16½

U Shape Typical
OS56†
Total List: \$4,367.00
71"W x 107"D x 65½"H
Excludes Seating, Keyboard System & Accessories
Pictured w/CoolMesh & Aero Seating

OS127 | Components

SKU #	QTY	DESCRIPTION	W x D x H
PL101†	1	Desk Shell	71 x 35½ x 29½
PL145†	1	Reversible Return	47 x 24 x 29½
PL166†	1	Deluxe Full Pedestal - B/B/F	15½ x 22 x 28½
PL175†	1	Deluxe Full Pedestal - F/F	15½ x 22 x 28½
PL144OH†	1	Open Hutch	71 x 15 x 36
PL44SLIDESGD	2	Sliding Glass Doors (Sets of 2)	18 x ½ x 15¾
PL44RAIL	1	Rails For Glass Doors	69 x 1 x 1
PL118	1	Tack Board (Visconti Fabric)	68% ₁₀ x ½ x 16½

Standard Pull Options
Customize Your Pull Options - See Page 35



NEW! AE American
Elm w/Silver Pulls
(†Select SKUs)

CG Coastal Gray
w/Silver Pulls

ES Espresso
w/Silver Pulls



MW Modern Walnut
w/Silver Pulls

MH Mahogany
w/Black Pulls

CH Cherry
w/Black Pulls

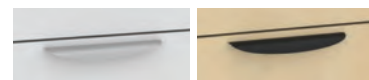

WH White
w/Silver Pulls

MA Maple
w/Black Pulls

Note: American Elm only available for select SKUs. Select SKUs are noted by a † mark at the end of their SKU.



OS LAMINATE
Maple Finish

L Shape Typical
OS244†
Total List: \$5,971.00
90½"W x 66"D x 65½"H
Excludes Seating & Accessories
Pictured w/Cade Seating



OS233 | Components

SKU #	QTY	DESCRIPTION	W x D x H
PL189†	1	Bow Front Desk Shell	71 x 36/41 x 29½
PL193†	1	Bridge	35 x 24 x 29½
PL182R†	1	Credenza w/Corner Ext (Rt)	71 x 24/36 x 29½
PL144OH†	1	Open Hutch	71 x 15 x 36
PL44SGD	1	Silver Frame Glass Doors (Sets of 2)	17 x ¾ x 15¾
PL166†	1	Deluxe Full Pedestal - B/B/F	15½ x 22 x 28½
GBM1769	1	Magnetic Glass White Board	68½ x ½ x 16½

U Shape Typical
OS233†
Total List: \$4,514.00
71"W x 112"D x 65½"H
Excludes Seating & Accessories
Pictured w/CoolMesh Pro Seating

OS244 | Components

SKU #	QTY	DESCRIPTION	W x D x H
PL207†	1	Wardrobe Unit	24¼ x 23¾ x 65½
PL181R†	1	Credenza w/Corner Ext. - Rt	66 x 24/36 x 29½
PL179†	1	Reversible Return	30 x 24 x 29½
PL166†	1	Deluxe Full Pedestal - B/B/F	15½ x 22 x 28½
PL140OH†	1	Open Hutch	66 x 15 x 36
PL40LD†	1	Laminate Doors	16 x ½ x 15¾
PL117	1	Tack Board (Gray Fabric)	64 x ½ x 16½
OSPULLBARBK	7	Modern Bar Pulls	7 x 1 x 1

Note: Typical sold with optional pulls - See Page 35 for standard pulls.

Additional Pull Options

Customize Your Pull Options - See Page 35



Rectangular Pull
Silver Only



Modern Bar Pull
Silver



Modern Bar Pull
Black



Modern Metro Pull
Silver



Modern Metro Pull
Black



Modern Metro Pull
Gray



Mid-Century Pull
Silver



Mid-Century Pull
Black



Mid-Century Pull
Gray

*Note: American Elm **only** available for select SKUs. Select SKUs are notated by a † mark at the end of their SKU.*



U Shape Typical
OS243†
 Total List: \$7,637.00
 106½"W x 112¼"D x 65½"H
 Excludes Seating & Accessories
 Pictured w/CoolMesh Pro Seating

OS LAMINATE
 White Finish



OS264 | Components

SKU #	QTY	DESCRIPTION	W x D x H
PL189†	1	Bow Front Desk Shell	71 x 36/41 x 29½
PL170†	1	Bridge	47 x 24 x 29½
PL143†	1	Credenza Shell	71 x 24 x 29½
PL166†	2	Deluxe Full Pedestal - B/B/F	15½ x 22 x 28½
PL144OH†	1	Open Hutch	71 x 15 x 36
PL44LD†	2	Laminate Hutch Doors (Set of 2)	17 x ¾ x 15¾

U Shape Typical
OS264†
 Total List: \$4,359.00
 71"W X 112"D X 65½"H
 Excludes Seating & Accessories
 Pictured w/CoolMesh & Advanced Seating

Note: American Elm only available for select SKUs.
 Select SKUs are notated by a † mark at the end of their SKU.

OS243 | Components

SKU #	QTY	DESCRIPTION	W x D x H
PL189†	1	Bow Front Desk Shell	71 x 36/41 x 29½
PL170†	1	Bridge	47 x 24 x 29½
PL143†	1	Credenza Shell	71 x 24 x 29½
PL166†	1	Deluxe Full Pedestal - B/B/F	15½ x 22 x 28½
PL144OH†	1	Open Hutch	71 x 15 x 36
PL44SGD	2	Silver Frame Glass Doors (Sets of 2)	17 x ¾ x 15¾
PL118	1	Tack Board (Gray Fabric)	68% x ½ x 16½
PL112†	1	2 Drawer Lateral File	35½ x 22 x 29½
PL152†	1	Storage Cabinet	35½ x 22 x 37¼
PL152SGD	1	Silver Frame Glass Cabinet Doors	17½ x ½ x 36¼

Standard Pull Options
 Customize Your Pull Options - See Page 35



NEW! AE American Elm w/Silver Pulls
 (†Select SKUs)

CG Coastal Gray w/Silver Pulls

ES Espresso w/Silver Pulls



MW Modern Walnut w/Silver Pulls

MH Mahogany w/Black Pulls

CH Cherry w/Black Pulls

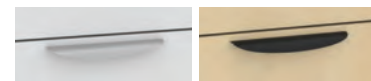

WH White w/Silver Pulls

MA Maple w/Black Pulls



OS LAMINATE
White Finish

**NEW! Modern Typical
OSTYP323†**
Total List: \$9,316.00
142"W x 72"D x 65½"H
Excludes Accessories



OS96 | Components

SKU #	QTY	DESCRIPTION	W x D x H
PL181R†	1	Credenza w/Corner Ext - Rt	66 x 24/36 x 29½
PL179†	1	Reversible Return	30 x 24 x 29½
PL107†	1	Hanging 3/4 Pedestal - B/F	15½ x 22 x 19
PL140OH†	1	Open Hutch	66 x 15 x 36
PL40LD†	2	Laminate Doors (Sets of 2)	16 x ½ x 15¾
PL117	1	Tack Board (Gray Fabric)	64 x ½ x 16½

**L Shape Typical
OS96†**

Total List: \$3,029.00
66"W x 66"D x 65½"H
Excludes Accessories

Note: American Elm **only** available for select SKUs.
Select SKUs are notated by a † mark at the end of their SKU.

NEW! OSTYP323 | Components

SKU #	QTY	DESCRIPTION	W x D x H
PL1012†	2	2 Drawer Persona Cabinet	35½ x 22 x 22
PL2013†	2	Open Shelf Cabinet	35½ x 22 x 22
PL110†	1	File/Storage Top	71 x 22 x 1
CUSH2136	1	Top Cushion	35½ x 22 x 1½
PL109†	1	File/Storage Top	35½ x 22 x 1
PLTLEGBV30	1	Beveled Leg Base	30 x 3 x 28¾
PLTADJMDB4872	1	Adjustable Beam	67¾ x 2 x 1
PLTDR2430	1	Desk Riser	23¾ x 2 x 6½
PLT3072†	1	Rectangular Top	72 x 30 x 1
PL152†	1	Storage Cabinet	35½ x 22 x 37¼
PL208OH†	2	Open Hutch	36½ x 15 x 17
PLTCBBEV	1	Connector Beam Bracket	
OSPULLHLBK	6	Black Crescent Pulls	7 x 1 x 1

Note: Typical Sold With Optional Pulls - See Page 35 for Standard Pulls.

Additional Pull Options

Customize Your Pull Options - See Page 35



Rectangular Pull
Silver Only



Modern Bar Pull
Silver



Modern Bar Pull
Black



Modern Metro Pull
Silver



Modern Metro Pull
Black



Modern Metro Pull
Gray



Mid-Century Pull
Silver



Mid-Century Pull
Black



Mid-Century Pull
Gray



OS LAMINATE
Combination Finish

U Shape Typical
OS21†

Total List: \$7,350.00

106½"W x 112"D x 65½"H

Excludes Seating & Accessories
Pictured w/Bradley & Tre Seating



OS235 | Components

SKU #	QTY	DESCRIPTION	W x D x H
PL101†	1	Desk Shell	71 x 35½ x 29½
PL166†	1	Deluxe Full Pedestal - B/B/F	15½ x 22 x 28½
PL175†	1	Deluxe Full Pedestal - F/F	15½ x 22 x 28½
OSPULLRSI	5	Rectangular Pulls	7 x 1 x 1

Note: Typical Sold With Optional Pulls - See Page 35 for Standard Pulls.

Note: American Elm **only** available for select SKUs.

Select SKUs are notated by a † mark at the end of their SKU.

OS21 | Components

SKU #	QTY	DESCRIPTION	W x D x H
PL189†	1	Bow Front Desk Shell	71 x 36/41 x 29½
PL170†	1	Bridge	47 x 24 x 29½
PL143†	1	Credenza Shell	71 x 24 x 29½
PL166†	1	Deluxe Full Pedestal - B/B/F	15½ x 22 x 28½
PL144OH†	1	Open Hutch	71 x 15 x 36
PL44SGD	1	Silver Frame Glass Doors (Sets of 2)	17 x ¾ x 15¾
PL112†	1	Two Drawer Lateral File	35½ x 22 x 29½
PL152†	1	Storage Cabinet	35½ x 22 x 37¼
PL152SGD	1	Silver Frame Glass Cabinet Doors	17½ x ½ x 36¼
GBM1769	1	Magnetic Glass White Board	68½ x ½ x 16½

Standard Pull Options

Customize Your Pull Options - See Page 35



NEW! AE American Elm w/Silver Pulls
(†Select SKUs)



CG Coastal Gray w/Silver Pulls



ES Espresso w/Silver Pulls



MW Modern Walnut w/Silver Pulls



MH Mahogany w/Black Pulls



CH Cherry w/Black Pulls



WH White w/Silver Pulls



MA Maple w/Black Pulls

Note: Must specify color(s) when ordering combination typicals.

Simple Desk Typical
OS235†

Total List: \$2,379.00

71"W x 35½"D x 29½"H

Excludes Seating & Accessories
Pictured w/Cade Seating



OS LAMINATE
Combination Finish

U Shape Typical
OS234†
Total List: \$4,907.00
72"W x 108"D x 65½"H
Excludes Seating & Accessories
Pictured w/CoolMesh Pro Seating



OS97 | Components

SKU #	QTY	DESCRIPTION	W x D x H
PL169NTT†	1	Reception Desk Shell	71 x 30 x 40½
PL169TT†	1	Transaction Top	71 x 17¾ x 1
PL169RISER	1	Metal Counter Riser	¾ Dia x 1
PL180†	1	Reception Return Shell	42 x 24 x 40½
PL107†	2	Hanging 3/4 Pedestal - B/F	15½ x 22 x 19

Reception Typical
OS97†

Total List: \$2,805.00
71"W x 78"D x 42½"H
Excludes Seating & Accessories
Pictured w/CoolMesh Seating

Note: American Elm **only** available for select SKUs.
Select SKUs are notated by a † mark at the end of their SKU.

OS234 | Components

SKU #	QTY	DESCRIPTION	W x D x H
PL105†	1	Desk Shell	71 x 30 x 29½
PL166†	1	Deluxe Full Pedestal - B/B/F	15½ x 22 x 28½
PL144OH†	1	Open Hutch	71 x 15 x 36
PL44LD†	1	Laminate Hutch Doors	17 x ¾ x 15¾
GBM1769	1	Magnetic Glass White Board	68½ x ½ x 16½
PLT2448†	1	Return Top	48 x 24 x 1
PLT3072†	1	Rectangular Top	72 x 30 x 1
PLTULEG30	2	Unite Leg	29½ x 1 11/16 x 28½
PLTADJMDB4872	1	Top Support Beam	67¾ x 2 x 1
PLTFB	4	Flat Brackets	
PLTCBBSINGLE	2	Connector Beam Bracket	
PLT72MSBK	1	Stiffener Support (Set of 2)	60¼ x 2¼ x 1

Additional Pull Options

Customize Your Pull Options - See Page 35



Rectangular Pull
Silver Only



Modern Bar Pull
Silver



Modern Bar Pull
Black



Modern Metro Pull
Silver



Modern Metro Pull
Black



Modern Metro Pull
Gray



Mid-Century Pull
Silver



Mid-Century Pull
Black



Mid-Century Pull
Gray

Note: Must specify color(s) when ordering combination typicals.

VARIANT

Base Styles (3 Base Options)

Work Surfaces (2 Shapes, Several Sizes, 8 Finish Options)



Note: Tops, Legs & Supports are sold separately to create more flexible workstation options.

VARIANT

Variant by OfficeSource® boasts sleek, stylish components that promote diversity, simplicity and functional modularity.

All leg options come standard with adjustable glides.

Coordinates well with our OS Laminate by OfficeSource® storage units, mounted hutches, privacy panels, upholstered seat cushions, surface mount power modules and cable management trays.

These features create working environments that are alive and inspirational in many kinds of offices. From classic offices to open concept layouts, the endless possibilities of the Variant will surely enhance creativity and productivity in the workplace.

Choose Your Configuration Style (Unite & Oblique Leg Styles Pictured Below)



28 1/2" Height ▲
41" Height ▶



▲ 24"D Return Tops
w/Riser + Storage



w/Ext. Support ▲
w/Oblique Leg ▶

Configuration Diagram #1

Single Desk (28 1/2"H - Silver or Black)
Single Desk (41"H - Unite Leg Only)

Note: 41"H Leg (Silver Only)

Configuration Diagram #2

L Shape Desk
Available in 28 1/2"H

Configuration Diagram #3

L Shape Desk
Available in 28 1/2"H



w/U Support Brackets ▲



w/Multi-Person Workstations ▲



Back-to-Back Workstations ▲

Configuration Diagram #4

U Shape Desk
Available in 28 1/2"H

Configuration Diagram #5

Multi-Person Workstations
Available in 28 1/2"H

Configuration Diagram #6

Back-to-Back Desks (Oblique Leg)
Available in 28 1/2"H
Note: Gap can be left in center for wire management.

Laminate Top Finishes

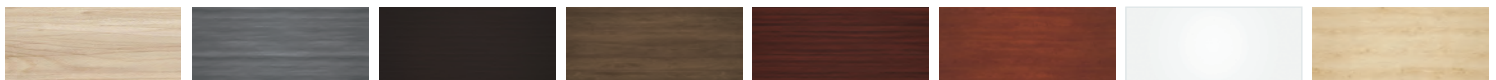

NEW! AE American Elm
(†Select SKUs)

CG Coastal Gray

ES Espresso

MW Modern Walnut

MH Mahogany

CH Cherry

WH White

MA Maple

Note: American Elm **only** available for select SKUs. Select SKUs are notated by a † mark at the end of their SKU.

Metal Leg Base Finishes



BK Black

SI Silver

Wood Leg Base Finishes

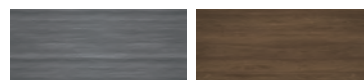

CG Coastal Gray

MW Modern Walnut

VARIANT

UNITE STYLE BASES

Unite Legs available in two heights: 28½" & 41"H. Also, available with an adjustable height base - 24-28½"H.

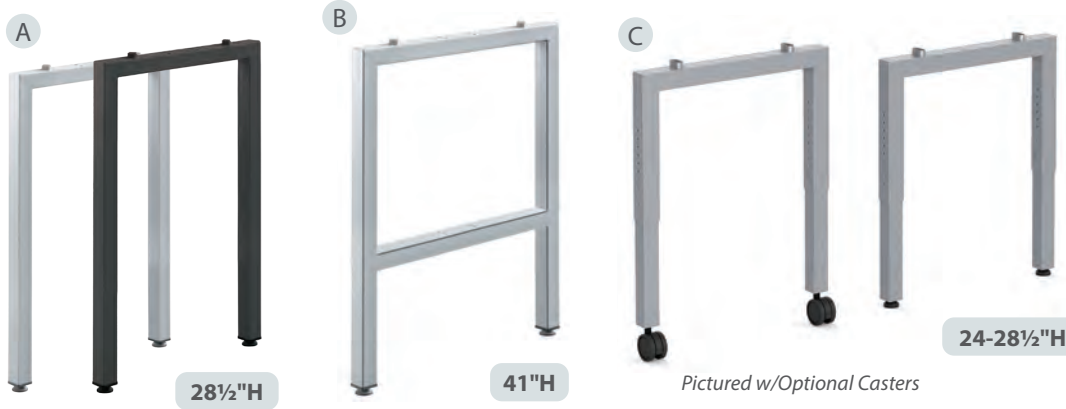

A Unite Leg Bases - 28½"H

PLTULEG24	(For 24"D Tops)	\$326.00
PLTULEG30	(For 30"D Tops)	\$341.00
PLTULEG36	(For 36"D Tops)	\$464.00
PLTULEG48	(For (2) 24"D Tops)	\$492.00
PLTULEG60	(For (2) 30"D Tops)	\$522.00

Available in BK Matte Black or SI Silver

B Unite Leg Bases - 41"H

PLTULEG2441A1	(For 24"D Tops)	\$375.00
PLTULEG3041	(For 30"D Tops)	\$384.00
PLTULEG3641	(For 36"D Tops)	\$506.00

Available in SI Silver

Note: 41"H Legs require additional **PLTADJMDB4872** adjustable beam.

C Unite Adjustable Height Leg Bases - 24 - 28½"H

PLTULEG2485H	(For 24"D Tops)	\$362.00 ea.
---------------------	-----------------	--------------

Available in BK Matte Black or SI Silver

DESK RISERS

Desk risers are used when using modular storage.

D Desk Riser

PLTDR2430	(For 24"D & 30"D Tops)	\$207.00
------------------	------------------------	----------

Available in BK Matte Black or SI Silver

Note: **PLTCBBSINGLE** is included with the desk riser.

E Low Desk Riser - 3¼"H

PLTLDR2430	(For 24"D & 30"D Tops)	\$174.00
-------------------	------------------------	----------

Available in BK Matte Black or SI Silver

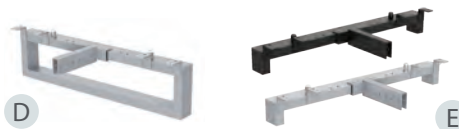

28½"H

BEVELED STYLE LEG BASES

F Beveled Leg Bases - 28½"H

PLTLEGBV24	(For 24"D Tops)	\$448.00
PLTLEGBV30	(For 30"D Tops)	\$501.00
PLTLEGBV36	(For 36"D Tops)	\$626.00
PLTLEGBV48	(For (2) 24"D Tops)	\$750.00
PLTLEGBV60	(For (2) 30"D Tops)	\$827.00

Available in BK Matte Black or SI Silver

OFFSET SQUARE POST LEG

Offset post legs are used for 120° desk tops & other freestanding/training tables

G Offset Square Leg

PLTSQPOSTLEG	
---------------------	--

List: \$253.00 ctn.

Available in BK Matte Black or SI Silver

Note: Priced and sold as (2) per carton.



28½"H

Metal Finishes



BK Black

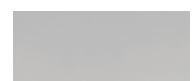

SI Silver

REQUIRED SUPPORTS



Adjustable Beam

PLTADJMDB4872

(Extends for Desks 48-72"W)

List: \$181.00 ea.

PLTADJMDB7896

(Extends for Desks 78-96"W & 48"W Bridge Tops)

List: \$224.00 ea.



Beam Cover

PLTMDB72C

(Cover to Conceal Adj. Beam & Hardware - For 72"W Tops Only)

List: \$154.00 ea.



Return Bracket

PLTRBB (For Adjustable Beams)

List: \$64.00 ea.

Note: Includes (2) **PLTFB**.



Connector Beam Bracket

PLTCBBSINGLE

(Required For Unite Leg Bases)

List: \$56.00 ea.

Note: 1 or 2 required depending on usage.



Connector Beam Bracket

PLTCBBEV

(Required For Beveled Leg Bases)

List: \$83.00 ea.

Note: 1 or 2 required depending on usage.

Note: All bases require beams & brackets. See Page 119.

VARIANT

OBLIQUE STYLE BASES

Oblique Legs available in two heights: 28½" & 41"H. Oblique legs sold separately from leg mounts.

Note: Please be sure to order both legs and mounts at time of purchase.



A Oblique Leg Bases - 28½"H

PLTVAMETLEG	(Metal Legs)	\$140.00
PLTVAWLEG	(Wood Legs)	\$154.00

Available in BK Matte Black, SI Silver, MW Modern Walnut & CG Coastal Gray.

Note: Oblique legs require PLTVALEGM leg mounts.

B Oblique Leg Bases - 41"H

PLTVAMETLEG41A1	(Metal Legs)	\$191.00
------------------------	--------------	----------

Available in BK Matte Black or SI Silver

Note: 41"H Metal Oblique Legs require support leg kits. Legs require at least (2) Adjustable Beams when used.

REQUIRED SUPPORTS - 41"H LEGS

Support Leg Kit (For 41"H Oblique Legs Only)

PLTVALEGM243041CB	(24-30")	\$245.00
PLTVALEGM364241CB	(36-42")	\$332.00
PLTVALEGM486041CB	(48-60")	\$451.00

Available in BK Matte Black or SI Silver

Note: Contains cross beam & leg mount.



ADDITIONAL SUPPORTS

G Return Support PLTRETUPPORT

10½"W x 7"D x 2½"H
List: \$87.00 ea.



Return supports are to make a table under 48" or any other configuration where a beam cannot be used due to shorted or odd lengths.

H Stiffener Support

PLT60MSBK (For 60"D Tops)
List: \$112.00 ctn.

PLT72MSBK (For 72"D Tops)
List: \$140.00 ctn.

Stiffener is a beam used to prevent any sagging of table tops.
Note: PLT60MSBK & PLT72MSBK priced (2) per carton.



I Flat Bracket PLTFBBK

List: \$28.00 ea.



Note: Flat Bracket can be shipped by a small package carrier.



Pictured w/Willow Seating & NEW! OSTYP330 Typical

Inset Legs Pair Well With Unite Leg Bases

HALF & INSET LEGS

E Half Leg - 28½"H

PLTULEGHALF \$271.00
(For 24"D & 30"D Tops)

Available in BK Matte Black or SI Silver

Ideal For Shared Single Depth Work Surfaces. Allows More Leg Room.

F Inset Leg - 28½"H

PLTULEG4860ILCMB \$737.00

(Includes a removable wire management cover & PLTMBMBC Brackets)

Available in SI Silver

Ideal For Shared Double Depth Work Surfaces. Allows More Leg Room.

REQUIRED SUPPORTS



Adjustable Beam PLTADJMDB4872

(Extends for Desks 48-72"W)
List: \$181.00 ea.

PLTADJMDB7896

(Extends for Desks 78-96"W & 48"W Bridge Tops)
List: \$224.00 ea.



Beam Cover PLTMDB72C

(Cover to Conceal Adj. Beam & Hardware - For 72"W Tops Only)
List: \$154.00 ea.



Return Bracket

PLTRBB (For Adjustable Beams)

List: \$64.00 ea.

Note: Includes (2) PLTFB.



Oblique Leg Mounts

PLTVALEGM2430

(For 24-30"D Tops)
List: \$140.00 ea.

PLTVALEGM3642

(For 36-42"D Tops)
List: \$169.00 ea.

PLTVALEGM4860

(For 48-60"D Tops)
List: \$253.00 ea.

Note: Required for both Metal & Wood Oblique Legs.



Connector Beam Bracket

PLTMBMBC (Pair)

(Required For Oblique Only When Shared)

List: \$70.00 ea.

Note: All bases require beams & brackets. See Page 119.

Metal Leg Base Finishes



BK Black

SI Silver

Wood Leg Base Finishes



CG Coastal Gray

MW Modern Walnut

VARIANT



RECTANGULAR DESK TOPS

PLT2436†	36"W x 24"D	\$315.00
PLT2448†	48"W x 24"D	\$360.00
PLT2460†	60"W x 24"D	\$405.00
PLT2466†	66"W x 24"D	\$443.00
PLT2472†	72"W x 24"D	\$443.00
PLT3048†	48"W x 30"D	\$393.00
PLT3060†	60"W x 30"D	\$487.00
PLT3066†	66"W x 30"D	\$519.00
PLT3072†	72"W x 30"D	\$519.00
PLT3672†	72"W x 36"D	\$628.00



RETURN TOPS

(36 - 48" Wide)		
PLT2436†	36"W x 24"D	\$315.00
PLT2442†	42"W x 24"D	\$344.00
PLT2448†	48"W x 24"D	\$360.00
(60 - 72" Wide)		
PLT2460†	60"W x 24"D	\$405.00
PLT2466†	66"W x 24"D	\$443.00
PLT2472†	72"W x 24"D	\$443.00



BULLET TOPS

PLT131T	66"W x 30"D	\$472.00
PLT147T	72"W x 36"D	\$578.00

PLT131T is available in *ES Espresso, MA Maple, MW Modern Walnut & CG Coastal Gray* Only.

PLT147T is available in *ES Espresso, MA Maple, MW Modern Walnut & CG Coastal Gray* Only.

Note: Rectangular Desk & Return Tops Require Beams & Brackets. See Page 119.



RECTANGULAR GLASS TOPS

PGT2460	60"W x 24"D	\$1,050.00
---------	-------------	------------

Note: Glass tops work with 24"D Unite Legs & 24"D Beveled Legs Only.

Available in *BK Black Tempered Glass*



PGT2460 Shown w/24" Beveled Legs in Silver



PGT2460 Shown w/24" Unite Legs in Silver

CABLE MANAGEMENT ACCESSORIES

CMS03 (<i>Spine</i>)	
30" Flexible Cord Concealer	\$103.00
Available in <i>SI Silver</i>	

OSWTSINGLE	
18" Single Wire Mesh Tray	\$239.00
Available in <i>BK Black</i>	

PLTPC18	
18" Power Trough w/Cover	\$93.00
Available in <i>BK Black</i>	

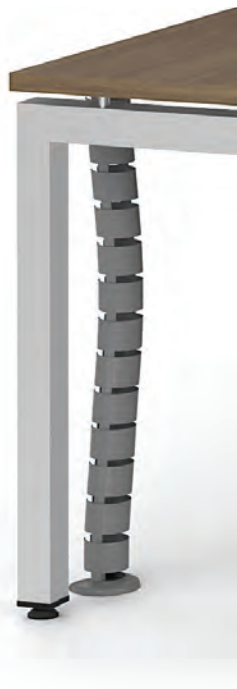

Easily Conceal Your Troublesome Wires & Cords With A Flexible 30" Spine Cord Concealer!

MODESTY PANELS

Metal Perforated Modesty Panels - 1½"D x 15"H
(18"H w/Included Brackets)

MMP1853	53" Wide	\$183.00
MMP1865	65" Wide	\$213.00

Available in *BK Matte Black & SI Silver*

Laminate Modesty Panels - ¾"D x 18"H

PLTLMP54	54" Wide	\$240.00
PLTLMP66	66" Wide	\$255.00

Available in *CH Cherry, MH Mahogany, ES Espresso, MA Maple, MW Modern Walnut, CG Coastal Gray & WH White* Only.



(Includes Brackets)



(Includes L Brackets)



NEW! AE American Elm (†Select SKUs)



CG Coastal Gray



ES Espresso

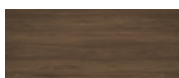

MW Modern Walnut



MH Mahogany (Select SKUs)



CH Cherry (Select SKUs)



WH White



MA Maple (Select SKUs)

Note: American Elm only available for select SKUs. Select SKUs are notated by a † mark at the end of their SKU.

VARIANT

LAMINATE LATERALS



2 Drawer Cabinet
PL1012†*
 35½"W x 22"D x 22"H
 List: \$1,359.00



Open Shelf Cabinet
PL2013†*
 35½"W x 22"D x 22"H
 List: \$824.00

*PL1012 & PL2013 - Top not included. Requires PL109 or PL110 if freestanding.



File Top (For PL1012 or PL2013)
PL109† - 35½"W
 List: \$239.00



Top Cushion
CUSH2136**
 List: \$445.00
 **Requires PL109 or PL110
 Available in **BL** Celestial Blue & **GK** Dark Gray

Credenza Top (For PL1012 or PL2013)
PL110† - 71"W
 List: \$325.00

PL110 sits on top of/can be applied to (2) PL112, (2) PL172, PL113, PL1012, PL2013 or PL152.

Note: PL109 is available in **NEW!** AE American Elm, ES Espresso, MW Modern Walnut, CG Coastal Gray & WH White Only.

Laminate finishes available in **NEW!** AE American Elm, CH Cherry, MH Mahogany, ES Espresso, MA Maple, MW Modern Walnut, CG Coastal Gray & WH White.

LAMINATE PEDESTALS



A PL166† (Box/Box/File)
 15½"W x 22"D x 28½"H
 List: \$696.00



B PL175† (File/File)
 15½"W x 22"D x 28½"H
 List: \$714.00



C Mobile Laminate Pedestal
PL1007† (Box/File)
 (Casters Included)
 16"W x 22½"D x 22½"H
 List: \$769.00

D Pedestal Top Cushion
CUSH1623 (For PL1007)
 List: \$237.00
 Available in **BL** Celestial Blue & **GK** Dark Gray



BL Celestial Blue



GK Dark Gray

Laminate finishes available in **NEW!** AE American Elm, CH Cherry, MH Mahogany, ES Espresso, MA Maple, MW Modern Walnut, CG Coastal Gray & WH White.

METAL LATERALS



2 Drawer Cabinet
836BF - 35½"W x 19¾"D x 20"H
 List: \$1,286.00
 Available in **SI** Silver
 Note: Cabinets stand at 23"H with casters or legs.

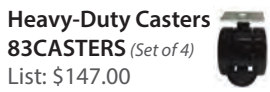

Heavy-Duty Casters
83CASTERS (Set of 4)
 List: \$147.00

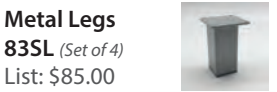

Metal Legs
83SL (Set of 4)
 List: \$85.00

Note: 83CASTERS & 83SL can be shipped by a small package carrier. 📦

METAL PEDESTALS



Metal Pedestals
CPSBBF (Box/Box/File)
CPSFF (File/File)
 15"W x 22"D x 26¾"H
 List: \$676.00 ea.



Mobile Metal Pedestal
CPSBF
 (Casters Included)
 15"W x 22"D x 22¼"H
 List: \$602.00

Includes counter weights on all metal pedestal units

Pedestal Top Cushion
CUSH1522 (For CPS Peds)
 List: \$221.00

Available in **BL** Celestial Blue & **GK** Dark Gray

Available in **BK** Black, **CR** Charcoal, **GT** Light Gray, **SI** Silver & **WH** White.
CPSBF: **WH** White, **BK** Black & **SI** Silver Only.

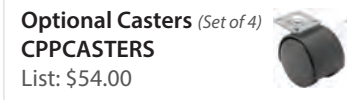

Optional Casters (Set of 4)
CPPCASTERS
 List: \$54.00

MINI LEG BASES



Angled Wood Mini Legs
PLTAWRLEG (Set of 4)
 List: \$120.00

Available in **NO** Natural Oak, **MW** Modern Walnut & **CG** Coastal Gray.



Straight Metal Mini Legs
PLTSMRLEG (Set of 4)
 List: \$171.00

Available in **BK** Matte Black or **SI** Silver

Note: Mini Legs can be shipped by a small package carrier. 📦



Pictured w/CoolMesh Seating & **NEW!** OSTYP302 Typical

Note: American Elm **only** available for select SKUs. Select SKUs are notated by a † mark at the end of their SKU.

VARIANT



NEW! OSTYP324 Typical



NEW! OSTYP301 Typical



NEW! OSTYP311 Typical
(w/Optional Wall Hutch - Not Included)

WALL MOUNTED OPEN HUTCHES



Open Hutch (31 or 36 1/2" Wide)



Open Hutch (71" Wide)

Open Hutch - 31"W PL209OH

15"D x 17"H
List: \$519.00

Note: Doors not included.

Open Hutch - 36 1/2"W PL208OH†

15"D x 17"H
List: \$562.00

Note: Doors not included.

Open Hutch - 71"W PL2044OH†

15"D x 17"H
List: \$946.00

Note: Doors not included.

Available in NEW! AE American Elm,
CH Cherry, MH Mahogany, ES Espresso, MA Maple,
MW Modern Walnut, CG Coastal Gray & WH White.

OPEN HUTCHES & REQUIRED SUPPORTS



Pictured w/NEW! OSTYP310 Typical

A Open Hutch (Requires Supports)

PL1044OH† 71"W x 15"D x 17"H \$950.00

Note: Doors & supports not included.

Note: PL1044OH is not compatible with the optional sliding glass doors.

B Hutch Supports (Pair)

PLTLPHS27-27"H \$405.00

PLTLPHS20-20"H \$341.00

Available in BK Matte Black or SI Silver



Pre-drilled holes
for easy support
assembly.

OPTIONAL HUTCH DOORS



Optional Laminate Doors

PL41LD† (For PL209 & PL141 - Set of 2)

List: \$80.00

PL44LD†* (Set of 2)

List: \$83.00

*Note: All hutch door SKUs beginning with PL44 are for
PL144OH, PL1044OH, PL2044OH & PL208OH.

Available in NEW! AE American Elm, CH Cherry, MH Mahogany, ES
Espresso, MA Maple, MW Modern Walnut,
CG Coastal Gray & WH White.

Note: American Elm **only** available for select SKUs.

Select SKUs are notated by a † mark at the end of their SKU.



Optional Silver Framed Glass Doors

PL41SGD (For PL209 & PL141)

PL44SGD* (Set of 2)

List: \$373.00 ea.



Optional Sliding Glass Doors

PL44SLIDESGD* (2 Door Span)

List: \$256.00

PL44RAIL (Rails for PL144OH & PL2044OH)

List: \$150.00

Note: PL1044OH are not compatible
with the sliding glass doors.

OPTIONAL LOCK



Hutch Door Lock PLLDLOCKKIT

List: \$59.00 ea.

Available in BK Black
or SI Silver

VARIANT



L Shape Typical
OS217†
 Total List: \$4,121.00
 72"W x 71"D x 29½"H
 Excludes Accessories

72" x 71" Unite Leg L Shape Workstation:

Rectangular Top: PLT3072†, Unite Leg Base: PLTULEG30, Adjustable Beam: PLTADJMDB4872, Connector Beam Bracket: PLTCBBSINGLE, Low Desk Riser: PLTLDR2430, Open Shelf Cabinet: PL2013†, 2 Drawer Personal Cabinet: PL1012†, Credenza Top: PL110†, Straight Metal Mini Legs: PLTSMRLEG (2).

OS217 | Components



ADDITIONAL COLLECTION OPTIONS



Straight Metal Mini Legs
PLTSMRLEG (Set of 4)
 List: \$171.00
 Available in BK Matte Black or SI Silver



Low Desk Riser - 3¼"H
PLTLDR2430 (For 24"D & 30"D Tops)
 List: \$174.00
 Available in BK Matte Black or SI Silver

Note: Mini Legs can be shipped by a small package carrier. 📦

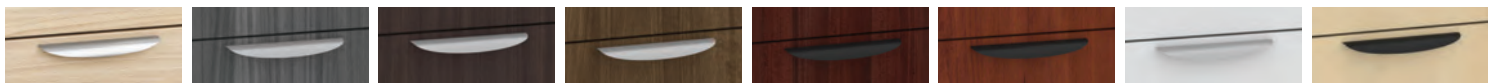

NEW! AE American Elm (†Select SKUs) CG Coastal Gray ES Espresso MW Modern Walnut MH Mahogany CH Cherry WH White MA Maple

Note: American Elm only available for select SKUs. Select SKUs are notated by a † mark at the end of their SKU.

VARIANT



**NEW! L Shape Typical
OSTYP311†**

Total List: \$3,889.00
72"W x 78"D x 29½"H
Excludes Seating & Accessories
Pictured w/Franklin Seating

72" x 78" Unite Leg L Shape Workstation:

Rectangular Tops: PLT3072† & PLT2448†, Unite Leg Bases: PLTULEG30 (2) & PLTULEG24, Adjustable Beams: PLTADJMDB4872 (2), Connector Beam Brackets: PLTCBBSINGLE (3), Return Bracket: PLTRBB, Flat Brackets: PLTFB (2), Pedestals: CPSBBF (2).



NEW! OSTYP311 | Components



NEW! AE American Elm CG Coastal Gray ES Espresso MW Modern Walnut MH Mahogany CH Cherry WH White MA Maple
(†Select SKUs)

Note: American Elm only available for select SKUs. Select SKUs are notated by a † mark at the end of their SKU.

VARIANT



NEW! Multi-Person Typical OSTYP303†
 Total List: \$12,754.00
 144"W x 72"D x 54"H
 Excludes Seating & Accessories
 Pictured w/Franklin Seating

144" x 72" Unite Leg Multi-Person Workstation:

Rectangular Tops: PLT2472† (4) & PLT2448† (4), Unite Leg Bases: PLTULEG48 (5), Adjustable Beams: PLTADJMDB4872 (8), Connector Beam Brackets: PLTCBBSINGLE (12), Return Brackets: PLTRBB (4), Frosted Acrylic Shields: PLTAP2466S (2), Shield Brackets: PLTSBUDMDUAL (2), Mobile Pedestal: PL1007† (4), Flat Brackets: PLTFB (8).

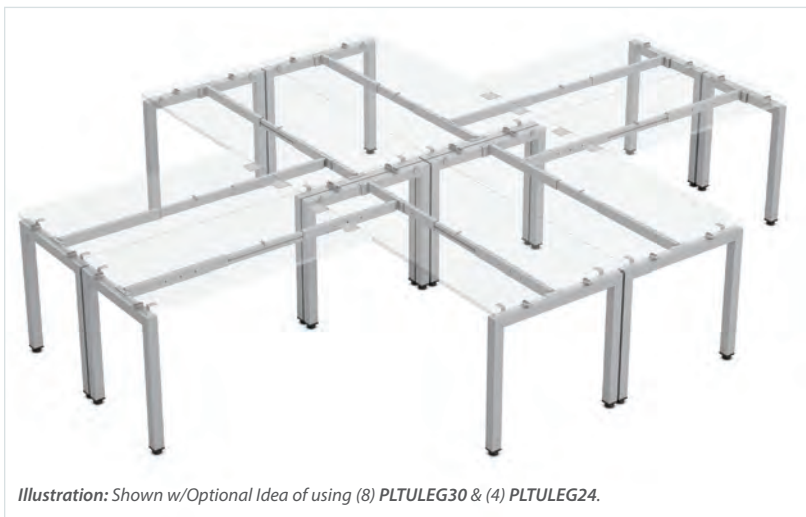

Illustration: Shown w/Optional Idea of using (8) PLTULEG30 & (4) PLTULEG24.

NEW! OSTYP303 | Components (For 4 Workstations Pictured Above)



NEW! AE American Elm (†Select SKUs) CG Coastal Gray ES Espresso MW Modern Walnut MH Mahogany CH Cherry WH White MA Maple

Note: American Elm only available for select SKUs. Select SKUs are notated by a † mark at the end of their SKU.



Multi-Person Typical

QSOS236†

Total List: \$20,616.00

216"W x 60"D x 54"H

Excludes Seating & Accessories

Pictured w/Cade Seating

216" x 60" Oblique Leg Multi-Person Workstation:

Rectangular Tops: PLT3072† (6), Oblique Metal Leg Bases: PLTVAMETLEG (6), Leg Mounts: PLTVALEGM4860 (6), Adjustable Beams: PLTADJMDB4872 (6), Clear Acrylic Shields: QSACRV2454C (3), Shield Brackets: PLTSBUDMDUAL (3), 2 Drawer Personal Cabinets: PL1012† (6), Cabinet Tops: PL109† (6), Top Cushions: CUSH2136 (6).



QSOS236 | Components

(For 6 Workstations Pictured Above)



QS = QUICKSHIP

Note: PL109 is not available in CH Cherry, MA Maple & MH Mahogany.

VARIANT



**Simple Typical
OS237**
 Total List: \$3,356.00
 72"W x 36"D x 29½"H
 Excludes Seating & Accessories
 Pictured w/Sierra & Manhattan Seating

72" x 36" Oblique Metal Leg Workstation:

Rectangular Top: PLT3072†, Oblique Metal Leg Bases: PLTVAMETLEG (2), Leg Mounts: PLTVALEGM2430 (2), Adjustable Beam: PLTADJMDB4872, 2 Drawer Lateral File: PL112†, Laminate Modesty Panel: PLTLMP54 & Open Hutch: PL153†.



OS237 | Components



NEW! AE American Elm
(†Select SKUs)

CG Coastal Gray

ES Espresso

MW Modern Walnut

MH Mahogany

CH Cherry

WH White

MA Maple

Note: American Elm only available for select SKUs. Select SKUs are notated by a † mark at the end of their SKU.

VARIANT



L Shape Typical OS216†

Total List: \$4,008.00
72"W x 71"D x 29½"H
Excludes Accessories
w/Optional Modern Pulls

72" x 71" Oblique Leg L Shape Workstation:

Rectangular Top: PLT3072†, Oblique Wood Leg Base: PLTVAWLEG, Adjustable Beam: PLTADJMDB4872, Leg Mount: PLTVALEGM2430, Low Desk Riser: PLTLDR2430, Open Shelf Cabinet: PL2013†, 2 Drawer Personal Cabinet: PL1012†, Credenza Top: PL110†, Angled Wood Mini Legs: PLTAWRLEG (2), Metro Pulls: OSPULLCYLBK (2).

OS216 | Components



ADDITIONAL COLLECTION OPTIONS



Angled Wood Mini Legs
PLTAWRLEG (Set of 4)
List: \$120.00

Available in **NO** Natural Oak, **MW** Modern Walnut & **CG** Coastal Gray.



Low Desk Riser - 3¼"H
PLTLDR2430 (For 24"D & 30"D Tops)
List: \$174.00

Available in **BK** Matte Black or **SI** Silver

Note: Mini Legs can be shipped by a small package carrier. 📦

Note: **PLTVAWLEG** is not available in the **NO** Natural Oak.



NEW! AE American Elm
(†Select SKUs)

CG Coastal Gray

ES Espresso

MW Modern Walnut

MH Mahogany

CH Cherry

WH White

MA Maple

Note: American Elm only available for select SKUs. Select SKUs are notated by a † mark at the end of their SKU.



NEW! Multi-Person Typical
QSOSTYP301†
 Total List: \$11,388.00
 144"W x 72"D x 65½"H
 Excludes Seating & Accessories
 Pictured w/CoolMesh Pro Seating

144" x 72" Unite Leg Two-Person Workstation:

Rectangular Top: PLT3072† (2), Unite Leg Bases: PLTULEG30 (2), Adjustable Beam: PLTADJMDB4872 (2), Desk Riser: PLTDR2430 (2), Open Shelf Cabinet: PL2013† (2), 2 Drawer Personal Cabinet: PL1012† (2), Credenza Top: PL110† (2), Open Hutch: PL1044OH† (2), Hutch Supports: PLTLPHS27 (2), Laminate Hutch Doors: PL44LD† (Set of 2) - (2), Connector Beam Brackets: PLTCBBSINGLE (2), Shield Brackets: PLTSBUDMSGL (Set of 2) (2), Clear Acrylic Shields: QSACRV2430C (2).

NEW! QSOSTYP301 | Components

(For 2 Workstations Pictured Above)



Additional Pull Options
 Customize Your Pull Options - See Page 35



Note: American Elm only available for select SKUs. Select SKUs are notated by a † mark at the end of their SKU.



NEW! L Shape Typical OSTYP325†
 Total List: \$5,974.00
 72"W x 90"D x 65½"H
 Excludes Seating & Accessories
 Pictured w/Franklin & Framed Seating

72" x 90" Beveled Leg L Shape Workstation:

Rectangular Top: PLT3072†, Beveled Leg Base: PLLEGBV30, Adjustable Beam: PLTADJMDB4872, Connector Beam Bracket: PLTCBBEV, Desk Riser: PLTDR2430, Open Shelf Cabinet: PL2013†, 2 Drawer Personal Cabinet: PL1012†, Credenza Top: PL110†, Open Hutch: PL1044OH†, Hutch Supports: PLTLPHS27, Laminate Hutch Doors: PL44LD† (Set of 2), Crescent Black Pulls: OSPULLHLBK (2), Magnetic Glass White Board: GBM1769.



NEW! OSTYP325 | Components

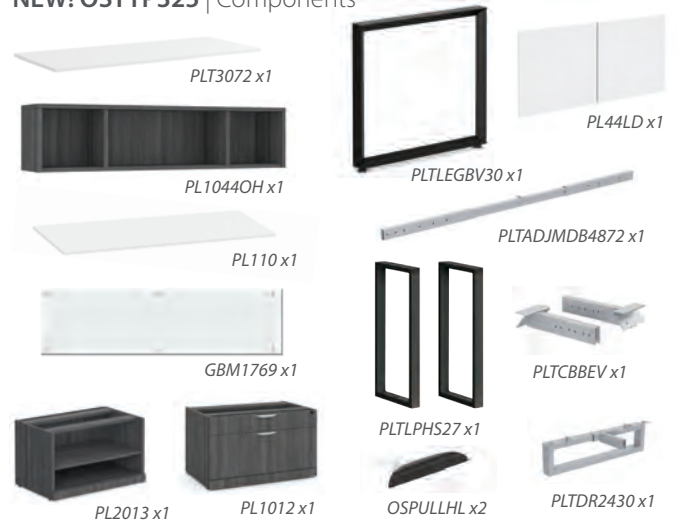

NEW! AE American Elm †Select SKUs | **CG Coastal Gray** | **ES Espresso** | **MW Modern Walnut** | **MH Mahogany** | **CH Cherry** | **WH White** | **MA Maple**

Note: American Elm only available for select SKUs. Select SKUs are noted by a † mark at the end of their SKU.

VARIANT



NEW! Multi-Person Typical OSTYP321†

Total List: \$7,915.00

144"W x 50"D x 29½"H

Excludes Seating & Accessories

Pictured w/NEW! Orion Seating

NEW! OSTYP321 | Components

SKU #	QTY	DESCRIPTION	W x D x H
PL1012†	2	2 Drawer Personal Cabinet	35½ x 22 x 22
PL2013†	2	Open Shelf Cabinet	35½ x 22 x 22
PL110†	2	File/Storage Top	71 x 22 x 1
PLT3072†	2	Rectangular Top	72 x 30 x 1
PLTDR2430	2	Desk Riser	23¾ x 2 x 6½
PLTULEG60	1	Unite Leg Base (For (2) 30"D Tops)	60 x 1½ x 28½
PLTCBBSINGLE	2	Connector Beam Bracket	
PLTADJMDB4872	2	Adjustable Beam	67¾ x 2 x 1
PLTSBUDMDUAL	1	Shield Bracket (Set of 2)	
PLTFP1566	1	Fabric Shield	66 x ½ x 15



NEW! Multi-Person Typical OSTYP300†

Total List: \$17,938.00

144"W x 144"D x 44½"H

Excludes Seating & Accessories

Pictured w/Franklin & Integrate Seating

NEW! OSTYP300 | Components

SKU #	QTY	DESCRIPTION	W x D x H
PL1012†	4	2 Drawer Personal Cabinet	35½ x 22 x 22
PL2013†	4	Open Shelf Cabinet	35½ x 22 x 22
PL110†	4	File/Storage Top	71 x 22 x 1
CUSH2136	4	Top Cushion	35½ x 22 x 1½
PLTLEGBV48	2	Beveled Leg Base	48 x 3 x 28¾
PLTCBBEV	4	Connector Beam Bracket	
PLTDR2430	4	Desk Riser	23¾ x 2 x 6½
PLTADJMDB4872	4	Adjustable Beam	67¾ x 2 x 1
PLT2472†	4	Rectangular Top	72 x 24 x 1
PLTSBUDMDUAL	2	Shield Bracket (Set of 2)	
PLTAP1566S	2	Frosted Acrylic Shield	66 x ¼ x 15



NEW! Multi-Person Typical OSTYP302†

Total List: \$13,768.00

144"W x 144"D x 65½"H

Excludes Seating & Accessories

Pictured w/CoolMesh Seating

NEW! OSTYP302 | Components

SKU #	QTY	DESCRIPTION	W x D x H
PLT2472†	4	Rectangular Top	72 x 24 x 1
PLT2448†	4	Rectangular Top	48 x 24 x 1
PLTLEGBV48	3	Beveled Leg Base	48 x 3 x 28¾
PLTLEGBV24	4	Beveled Leg Base	24 x 3 x 28¾
PLTADJMDB4872	8	Adjustable Beam	67¾ x 2 x 1
PLTCBBEV	12	Connector Beam Bracket	
PLTRBB	4	Return Bracket	
PLTSBUDMDUAL	2	Shield Bracket (Set of 2)	
PLTAP2466S	2	Frosted Acrylic Shield	66 x ¼ x 24
CPSBF	4	Mobile Metal Pedestal - B/F	15 x 22 x 22¼



STANDUP STANDING DESKS

Pictured w/NEW! OSTYP319 Typical - Page 81

Avoid The Harmful Long-Term Effects Of Too Much Sitting...

Health authorities recommend changing posture from a sitting to standing position throughout the day. Standing desks can help achieve this at the office.

OfficeSource® StandUp Standing desks are easy, quick and quiet to operate and offer the optimal vertical range to accommodate people of all sizes.



Pictured w/Acrylic Privacy Shields & Silver Brackets - Variation of OS228

Seven Base Options

Two Top Shapes

Several Top Sizes

Eight Top Finishes

Configure Your Way!

Adjustable Height Ranges:

2-Stage Electric - 27 $\frac{1}{16}$ " - 44 $\frac{1}{2}$ "

3-Stage Electric - 24 $\frac{1}{2}$ " - 50"

Corner Electric - 24 $\frac{1}{16}$ " - 50"

Crank Lift - 26 $\frac{1}{4}$ " - 42 $\frac{3}{4}$ "

Pneumatic Lift - 27" - 42 $\frac{1}{16}$ "

Laminate Deluxe Casing - 24 $\frac{1}{2}$ " - 50"

2-Stage Single Motor - 25 $\frac{3}{4}$ " - 45 $\frac{1}{2}$ "



Laminate Top Finishes

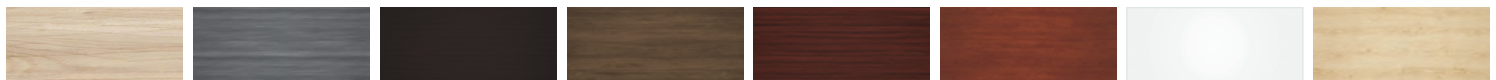

NEW! AE American Elm
(†Select SKUs)

CG Coastal Gray

ES Espresso

MW Modern Walnut

MH Mahogany

CH Cherry

WH White

MA Maple

Metal Base Finishes



BK Black
(Select SKUs)

SI Silver

Note: American Elm **only** available for select SKUs. Select SKUs are notated by a † mark at the end of their SKU.

STANDUP STANDING DESKS

Custom Build Your Standing Workstation By Combining Table Tops & Bases

ADJUSTABLE HEIGHT BASES

Seven different options to choose from. See Page 78 for details.

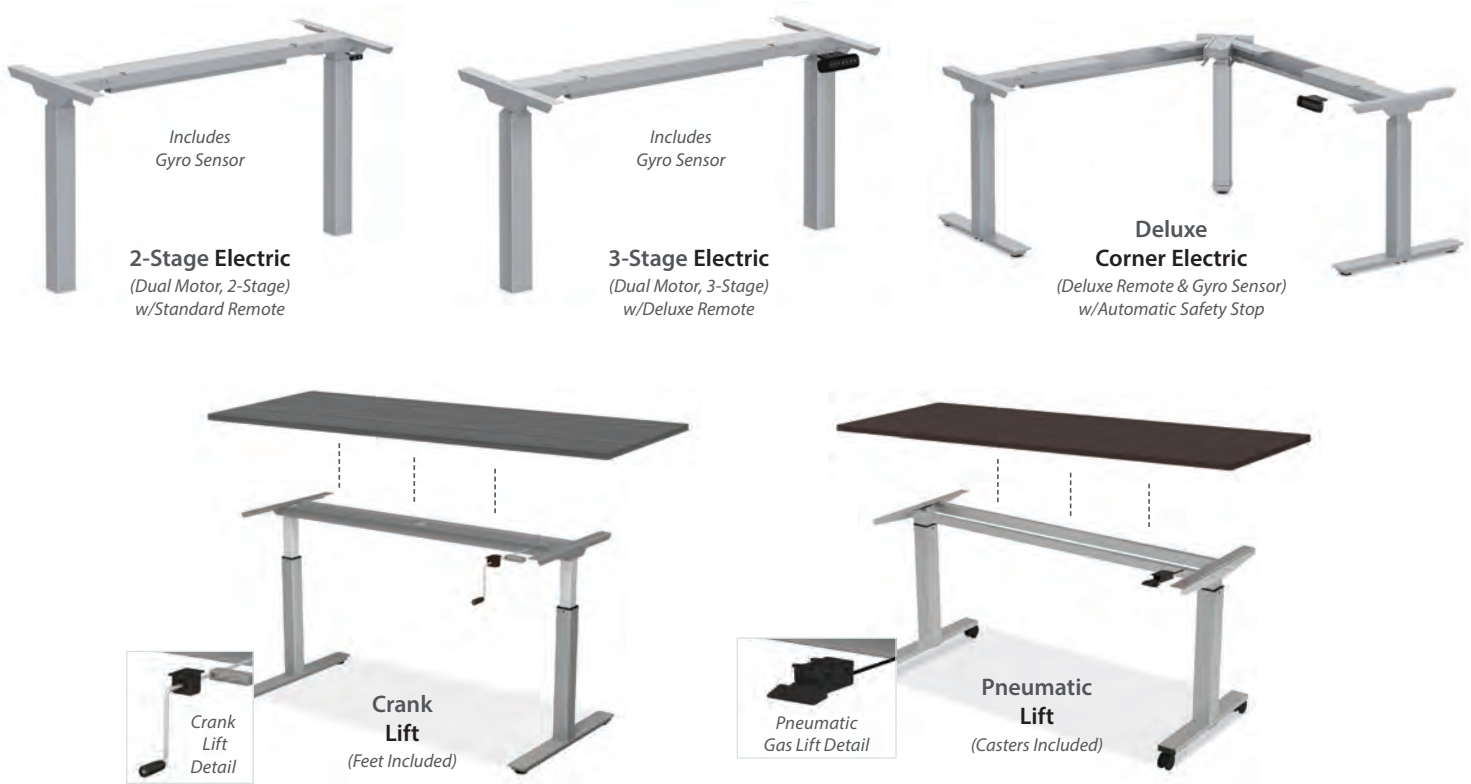

FEET STYLE OPTIONS & POWER PACK
(For Select 2-Stage & 3-Stage Electric Bases)

Standard Feet Power Pack
(Option For Caster Feet)

Laminate Deluxe Casing
For Executive Offices Or When
You Would Like To Hide
The StandUp Base Frame



SEVERAL TOP SHAPES & SIZES

Two top shapes, several different sizes & eight top finishes to choose from. See Page 79 for details.

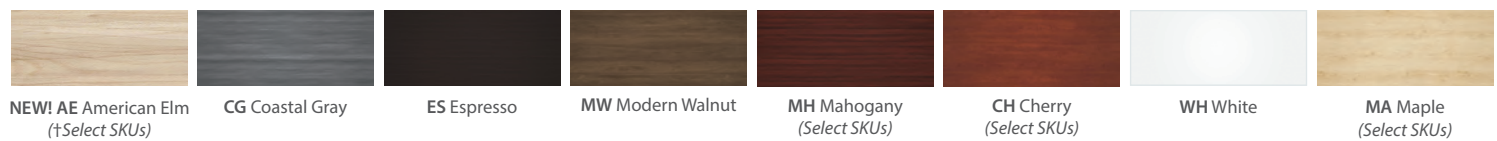

Note: American Elm only available for select SKUs. Select SKUs are notated by a † mark at the end of their SKU.

Note: PLT131T Available In ES Espresso, MA Maple, MW Modern Walnut & CG Coastal Gray Only.
PLT147T Available in ES Espresso, MA Maple, MW Modern Walnut & CG Coastal Gray Only.

STANDUP STANDING DESKS



A 2-Stage Electric Base w/Standard Remote

(For 24"D & 30"D Tops)

PLTEAB4872BUDECONF*

46⁵/₁₆"-70"W x 29⁹/₁₆"D x 27³/₁₆"-44¹/₂"H

List: \$1,579.00

Note: A-B Accommodates 48"W to 72"W table tops.

Note: Must Order Standard or Mobile Feet with A & B bases.

B 3-Stage Electric Base w/Deluxe Remote

(For 24"D & 30"D Tops)

PLTEAB4872ECONF*

46⁵/₁₆"-70"W x 29⁹/₁₆"D x 24⁷/₁₆"-50"H

List: \$1,985.00

C Single Motor, 2 Stage Height Adjustable Table Base

OSBHAT4860

37³/₈"-59"W x 23³/₈"D x 25³/₄"-45¹/₂"H

List: \$1,100.00

Note: OSBHAT4860 can be shipped by a small package carrier.

D 3-Stage, Electric Corner Base PLTECAB6078ECOWF*

54-69¹⁵/₁₆"W x 69¹⁵/₁₆"D x 24⁵/₈"-50"H

List: \$2,954.00

Note: Accommodates 60"W to 78"W table tops w/return tops 36"W to 48"W or 72"W x 78"W with a corner top.

E Crank Lift Bases

PLTCRKB36WF24

(For 24"D Tops)

35"W x 23³/₈"D x 26-42³/₄"H

PLTCRKB36WF30

(For 30"D Tops)

35"W x 29¹/₂"D x 26-42³/₄"H

List: \$1,156.00

Note: Accommodates 36"W to 48"W table tops.

PLTCRKB60WF24

(For 24"D Tops)

58¹/₄"W x 23³/₈"D x 26-39¹/₂"H

PLTCRKB60WF30

(For 30"D Tops)

58¹/₄"W x 29¹/₂"D x 26-39¹/₂"H

List: \$1,211.00

Note: Accommodates 60"W to 72"W table tops.

F Pneumatic Height Base w/Casters

PLTPHAB2460WF

(For 24"D Tops)

60"W x 24"D x 27-42³/₄"H

List: \$1,249.00

PLTPHAB3060WF

(For 30"D Tops)

60"W x 30"D x 27-42³/₄"H

List: \$1,327.00

Note: Accommodates 60"W table tops.

G Laminate Desk Casings

(Includes Electric Adjustable Base & Rectangular Top)

PLTHAT5172†

72"W x 75⁵/₈"D x 26³/₁₆"-49⁵/₈"H

List: \$3,605.00

PLTHAT5172 Available In **NEW!** AE American Elm, CH Cherry, MH Mahogany, ES Espresso, MA Maple, MW Modern Walnut, CG Coastal Gray & WH White Only.

Note: American Elm **only** available for select SKUs. Select SKUs are notated by a † mark at the end of their SKU.

Note: 83CASTERS can be shipped by a small package carrier.

Some items in this collection come ready-to-assemble.

OPTIONAL CASTERS - (FOR BASES A & B)



Optional Casters

(For Use With PLTHATFEET24 & 30)

83CASTERS (Set Of 4)

List: \$147.00

OPTIONAL ACCESSORIES

Programmable Remote w/USB Charger

(For A Electric Base Only)

PLTECODLXHANDSET

List: \$136.00



Battery Pack

(For A, B & D Electric Bases Only)

PLTECOBATTERY

List: \$610.00



FEET OPTIONS - (FOR BASES A & B)



Standard Feet (Set of 2)

PLTHATFEET24

23³/₈"W x 3¹/₈"D x 1¹/₂"H

PLTHATFEET30

29¹/₂"W x 3¹/₈"D x 1¹/₂"H

List: \$181.00

Single Adapter Foot w/Spacer

(When Combining Base With PL2013 + PL109HAT or PL110HAT)

PLTADAPTHATFOOT24

PLTADAPTHATFOOT30

List: \$131.00



Pictured w/Standard Feet

STANDUP STANDING DESKS

Choose Work Surface Style, Size & Shape *(Rectangular & Bullet Top)*



Rectangular Tops

PLT2448†	48"W x 24"D	\$360.00
PLT2460†	60"W x 24"D	\$405.00
PLT2466†	66"W x 24"D	\$443.00
PLT2472†	72"W x 24"D	\$443.00
PLT3048†	48"W x 30"D	\$393.00
PLT3060†	60"W x 30"D	\$487.00
PLT3066†	66"W x 30"D	\$519.00
PLT3072†	72"W x 30"D	\$519.00
PLT3672†	72"W x 36"D	\$628.00

Rectangular Return Tops

PLT2436†	36"W x 24"D	\$315.00
PLT2442†	42"W x 24"D	\$344.00
PLT2448†	48"W x 24"D	\$360.00
PLT2460†	60"W x 24"D	\$405.00

Bullet Tops

PLT131T	66"W x 30"D	\$472.00
PLT147T	72"W x 36"D	\$578.00

Note: PLT131T Available In ES Espresso, MA Maple, MW Modern Walnut & CG Coastal Gray Only.

Note: PLT147T Available in ES Espresso, MA Maple, MW Modern Walnut & CG Coastal Gray Only.



Pictured w/Hanging USB Mini Pedestal

LAMINATE STORAGE

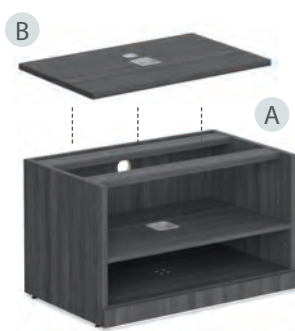

Or



A Open Shelf Cabinet

(For Use With HAT Unit)

PL2013†	35½"W x 22"D x 22"H	List: \$824.00
---------	---------------------	----------------

B Optional HAT Top

(For PL2013)

PL109HAT	35½"W x 22"D x 1"H	List: \$255.00
PL110HAT	71"W x 22"D x 1"H	List: \$344.00

Note: PL109HAT & PL110HAT is available in ES Espresso, MW Modern Walnut & CG Coastal Gray Only.

Note: PL2013 comes with an extra shelf that has not been pre-holed for possible use without the HAT unit involved.



Pictured w/OS229 Typical

MODESTY PANELS



(Includes Brackets)



(Includes L Brackets)

Metal Perforated Modesty Panels - 1½"D x 15"H

(18"H w/Included Brackets)

MMP1853	53" Wide	\$183.00
MMP1865	65" Wide	\$213.00

Available in BK Matte Black & SI Silver

Laminate Modesty Panels - ¾"D x 18"H

PLTLMP54	54" Wide	\$240.00
PLTLMP66	66" Wide	\$255.00

Available in CH Cherry, MH Mahogany, ES Espresso, MA Maple, MW Modern Walnut, CG Coastal Gray & WH White.

MINI PEDESTALS



Mini Pedestals

CMPBF (Box/File)	10"W x 20¼"D x 21"H	List: \$571.00
------------------	---------------------	----------------

Available In BK Black, SI Silver & WH White

Metal & Laminate Pedestals
See Pages 224-225

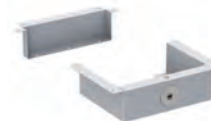

Hanging Bracket w/USB

CMPHBUSB (For CMPBF)	List: \$242.00
----------------------	----------------



Shown With Optional Top Cushion & Casters

Pedestal Top Cushion

CUSH1019 (For CMPBF)	List: \$216.00
----------------------	----------------

Available In BL Celestial Blue & GK Dark Gray

Optional Casters (Set of 4)

CPPCASTERS	List: \$54.00
------------	---------------



NEW! AE American Elm
(†Select SKUs)

CG Coastal Gray

ES Espresso

MW Modern Walnut

MH Mahogany
(Select SKUs)

CH Cherry
(Select SKUs)

WH White

MA Maple
(Select SKUs)

Note: American Elm only available for select SKUs. Select SKUs are notated by a † mark at the end of their SKU.



**Height Adjustable Typical
OS164†**
Total List: \$8,047.00
*Excludes Seating & Accessories
Pictured w/Sierra Seating*

STANDUP STANDING DESKS

FEATURES

- **Reduce the Risk of Obesity** - Standing from time-to-time introduces a variety of natural little movements to your day.
- **Reduce the Risk of Disease** - Sitting for extended periods contributes to metabolic problems including type 2 diabetes.
- **Less Cardiovascular Disease** - Simply put, sitting all day is bad for the heart.
- **Lowered Cancer Risk** - Recent studies potentially link prolonged sitting with increased breast and colon cancer risks.

OS174 | Components

SKU #	QTY	DESCRIPTION	W x D x H
PL143†	1	Credenza Shell	71 x 24 x 29½
PL114†	1	Combo Lateral File - B/B/F/Lat.	31 x 22 x 29½
PL144OH†	1	Open Hutch	72 x 15 x 36
PL44SGD	1	Silver Frame Glass Doors	17 x ¾ x 15¾
PL170†	1	Bridge	47 x 24 x 29½
PL142†	1	Credenza Half Leg	12¾ x 1 x 28
PLTHATS172†	1	Laminate Desk Casings	72 x 30 x 27¼-51
PLTAP1554S	1	Frosted Acrylic Shield	54 x ¼ x 15
OSTB400	2	Desk Mount Shield Bracket	

Height Adjustable Typical OS174†

Total List: \$7,761.00
72"W x 101"D x 65½"H
*Excludes Seating & Accessories
Pictured w/Provident Seating*

*Note: American Elm only available for select SKUs.
Select SKUs are notated by a † mark at the end of their SKU.*

OS164 | Components

SKU #	QTY	DESCRIPTION	W x D x H
PLTHATS172†	1	Laminate Desk Casing	72 x 30 x 27¼-51
PLTAP1554S	1	Frosted Acrylic Shield	54 x ¼ x 15
OSTB400	2	Desk Mount Shield Bracket	
PL112†	1	2 Drawer Lateral File	35½ x 22 x 29½
PL113†	1	Storage Cabinet	35½ x 22 x 29½
PL110†	1	File/Storage Top	71 x 22 x 1
PL1044OH†	1	Open Hutch	71 x 15 x 17
PL44SGD	1	Silver Frame Glass Doors	17 x ¾ x 15¾
PLTLPHS27	1	Hutch Supports (Set of 2)	27"H





STANDUP STANDING DESKS

**NEW! U Shape Typical
OSTYP319†**
Total List: \$5,759.00
72"W x 96"D
Excludes Seating & Accessories
Pictured w/Zella & Cade Seating



NEW! OSTYP319 | Components

SKU #	QTY	DESCRIPTION	W x D x H
PLTECAB6078ECOWF	1	3-Stage Electric Corner Base	54-69 ¹ / ₁₆ x 54-69 ¹ / ₁₆ x 24 ¹ / ₈ -50
PLT2472†	1	Rectangular Top	72 x 24 x 1
PLT2448†	1	Rectangular Top	48 x 24 x 1
PL143†	1	Credenza Shell	71 x 24 x 29 ¹ / ₂
PL114†	1	Combo Lateral File - B/B/F/Lat.	31 x 22 x 29 ¹ / ₂

Metal Base Finishes



BK Black
(Select SKUs)

SI Silver

Note: American Elm **only** available for select SKUs.
Select SKUs are notated by a † mark at the end of their SKU.

OS229 | Components

SKU #	QTY	DESCRIPTION	W x D x H
PL1012†	2	2 Drawer Personal Cabinet	35 ¹ / ₂ x 22 x 22
PL2013†	2	Open Shelf Cabinet	35 ¹ / ₂ x 22 x 22
PL110HAT	2	Optional Top	71 x 35 ¹ / ₂ x 1
PLT3072†	2	Rectangular Top	72 x 30 x 1
PLTEAB4872BUDECONF	2	3-Stage Electric Base	46 ¹ / ₈ -70 ¹ / ₄ x 23 ¹ / ₈ -29 ¹ / ₁₆ x 27 ³ / ₁₆ -44 ¹ / ₁₆
PLTADAPTHATFOOT30	2	Single Adapter Foot w/Spacer	29 ¹ / ₂ x 3 ³ / ₄ x 2 ¹ / ₁₆
CUSH2136	2	Top Cushion	35 ¹ / ₂ x 22 x 1 ¹ / ₂
OSF9500	2	Desk Mount Power Module	

Height Adjustable Typical OS229

Total List: \$11,394.00
145"W x 70³/₄"D x 25¹/₂-51"H
Excludes Accessories

OS229 available in CG Coastal Gray, ES Espresso & MW Modern Walnut Only.

Note: PL109HAT & PL110HAT is available in ES Espresso, MW Modern Walnut & CG Coastal Gray Only.



OS LAMINATE RECEPTION

Pictured w/Palma & Partridge Seating

**Reception Typical
OS153†**
Total List: \$2,919.00
71"W x 72"D x 41½"H
Excludes Seating & Accessories



NEW! AE American Elm
(†Select SKUs)

CG Coastal Gray

ES Espresso

MW Modern Walnut

MH Mahogany

CH Cherry

WH White

MA Maple

A Reception Desk Shell

PL169NTT†

71"W x 30"D x 40½"H

List: \$915.00

Note: Reception desk shells do not require transaction tops.

B Optional Reversible Return

PL180†

42"W x 24"D x 40½"H

List: \$571.00

C Optional Curved Glass Transaction Top

PL169TTGLASS

71"W x 17¾"D

List: \$737.00

*Available in FR Frosted Glass
w/Metal Risers Included*

D Optional Metal Risers

(Included w/PL169TTGLASS)

PL169RISER

List: \$119.00

*Available in BA
Brushed Aluminum*



Pictured w/OS232 Typical

E Optional Curved Laminate Transaction Top

PL169TT†

71"W x 17¾"D

List: \$198.00

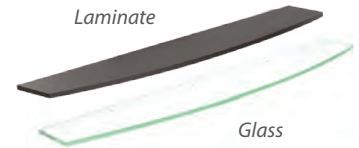

*Note: American Elm **only** available for select SKUs. Select SKUs are notated by a † mark at the end of their SKU.*

ADDITIONAL PRODUCTS



Reversible Reception Overlay

(For PL169NTT)

PL169DELTT

59"W x 11¼"D x 27¼"H

List: \$812.00



*Hangs Over
Existing Gables*



RISER FEATURES

Metal risers help to elevate laminate and glass transaction tops for a floating, sleek look



Note: When purchasing an optional transaction top, metal counter risers are not required.

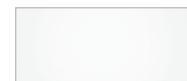

WH White

OS LAMINATE RECEPTION



Reception Typical OS36

Total List: \$3,795.00
72"W x 72"D x 42"H
Excludes Accessories
Transaction Top in CG & ES Only

OS36 | Components

SKU #	QTY	DESCRIPTION	W x D x H
PL181R†	1	Credenza w/Corner Ext. - Rt	66 x 24/36 x 29½
PL179†	1	Reversible Return	30 x 24 x 29½
PL166†	1	Deluxe Full Pedestal - B/B/F	15½ x 22 x 28½
PBTC66L	1	Corner Transaction Top - Left	66 x 12 x 1
PBTC66R	1	Corner Transaction Top - Right	66 x 12 x 1
PBP12	3	Posts	1¾ x 1¾ x 12
PB21266ACR	2	Acrylic Panel	66 x ¾ x 12

OS36 available in ES Espresso & CG Coastal Gray Only.



Reception Typical OS232†

Total List: \$2,380.00
71"W x 78"D x 41½"H
Excludes Seating & Accessories
Pictured w/Integrate Seating

OS232 | Components

SKU #	QTY	DESCRIPTION	W x D x H
PL169NTT†	1	Reception Desk Shell	71 x 30 x 40½
PL180†	1	Reception Return Shell	42 x 24 x 40½
PL169TT†	1	Transaction Top	71 x 17¾ x 1
PL166†	1	Deluxe Full Pedestal - B/B/F	15½ x 22 x 28½



Reception Typical OS77†

Total List: \$2,234.00
71"W x 35½"D x 42½"H
Excludes Seating & Accessories
Pictured w/CoolMesh Seating &
Optional Tempered Glass Chair Mat

OS77 | Components

SKU #	QTY	DESCRIPTION	W x D x H
PL169NTT†	1	Reception Desk Shell	71 x 30 x 40½
PL169TT†	1	Transaction Top	71 x 19¾ x 1
PL169RISER	1	Metal Counter Riser	¾ Dia x 1
PL107†	2	Hanging 3/4 Pedestal - B/F	15½ x 22 x 19

Note: American Elm **only** available for select SKUs. Select SKUs are notated by a † mark at the end of their SKU.



PALISADES - RECEPTION

A Reception Desk (Desk Only)
EVRC1L (Left)
EVRC1R (Right)
 87½"W x 37"D x 47½"H
 List: \$4,939.00

B Optional Reversible Return
EVRC2
 47¼"W x 23¾"D x 41¼"H
 List: \$950.00



EVRC1R - User Side

Tempered Glass
Transaction Top



EVRC1L - Profile Side



Optional Reversible Return

FEATURES

- Laminate is water, scratch, stain, fade & mildew resistant
- Sharp, contemporary design with a smoky Gauntlet Gray laminate finish for a sleek, modern look
- Base frame is made from durable metal with a graphite finish
- Boasts a ½" thick, tempered glass transaction top over graphite metal standoffs
- Pedestals house an optional power module that seamlessly integrates with two standard outlets and two USB outlets

PRODUCT FEATURES



Laminate tops have a 1.65" thick PVC edge and floating look

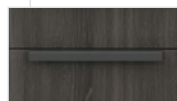

Modern graphite pulls complement the frame finish completely

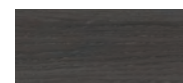

GG Gauntlet Gray w/Graphite Metal



**Reception Typical
COSMO1**
Total List: \$14,862.00
189"W x 63"D x 41"H
Includes: RCN3131C (2),
RCN6331 (2) & RCN32ADA (2)
Excludes Seating & Accessories

COSMO - RECEPTION

**A 63"W Reception Desk
w/Straight Glass Counter
RCN6331**
63"W x 31"D x 41"H
List: \$3,289.00

**B 47"W Reception Desk
w/Straight Glass Counter
RCN4731**
47"W x 31"D x 41"H
List: \$3,033.00

**C Curved Reception Corner
w/Curved Glass Counter
RCN3131C**
31½"W x 31½"D x 41"H
List: \$3,157.00

**D 32"W Reversible ADA Return
RCN32ADA**
31½"W x 31½"D x 29½"H
List: \$985.00

FEATURES

- Top panel is a 25mm thick MDF board with edge banding
- 8mm Tempered glass counter tops
- Laminate work surface resists scratches, stains & spills
- Two grommets per work station



CB Cordova Brown SG Steely Gray

Some items in this collection come ready-to-assemble.



**Reception Typical
COSMO2**
Total List: \$15,413.00
111"W x 79½"D x 41"H
Excludes Seating & Accessories

COSMO2 | Components

SKU #	QTY	DESCRIPTION	W x D x H
RCN4731	3	47" Reception Desk	47 x 31 x 41
RCN3131C	2	Curved Reception Corner	31½ x 31½ x 41

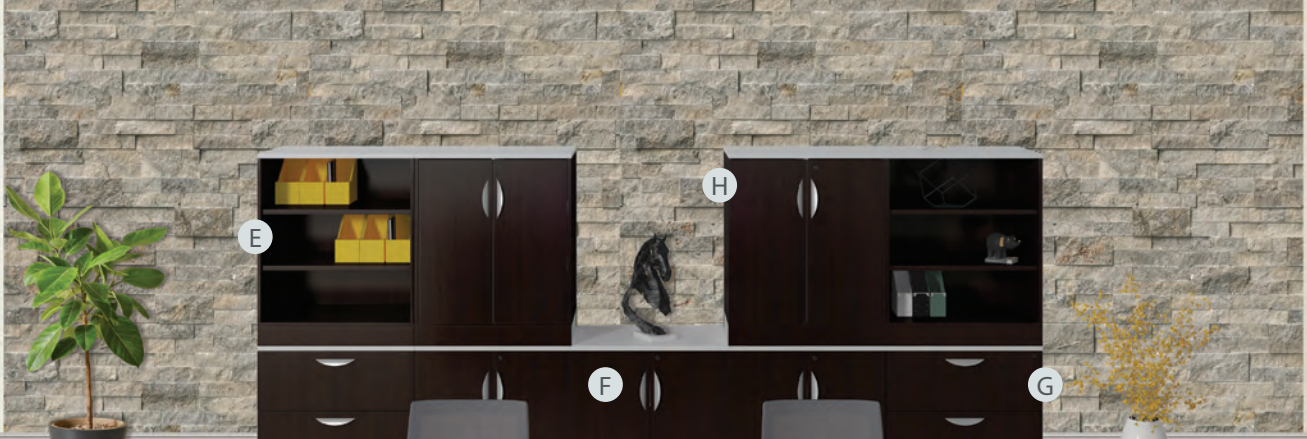

**Reception Typical
COSMO3**

Total List: \$23,359.00
 111"W x 31½"D x 41"H (Front Reception)
 157½"W x 22"D x 68½"H (Back Wall)
 Includes: RCN4731, RCN3131C (2), RCN3222BC (2), RCN3222STG (3), RCN3222LAT (2) & RCN3222WB (2)
 Excludes Seating & Accessories

COSMO

**E Bookcase Hutch
RCN3222BC**

31½"W x 22"D x 39"H
 List: \$1,546.00

**F Storage Cabinet
RCN3222STG**

31½"W x 22"D x 29½"H
 List: \$1,268.00

**G 2 Drawer Lateral File
RCN3222LAT**

31½"W x 22"D x 29½"H
 List: \$1,963.00

**H Wardrobe & Bookcase Hutch
RCN3222WB**

31½"W x 22"D x 39"H
 List: \$1,595.00

ADDITIONAL PRODUCTS



See Page 224 for full collection of laminate pedestals

Casters hidden behind laminate

**Mobile Pedestal
Box/Box/File
PL148†**

16"W x 22½"D x 28½"H
 List: \$946.00

Note: PL148 is only available in NEW! AE American Elm, CH Cherry, ES Espresso, MH Mahogany, MA Maple, MW Modern Walnut, CG Coastal Gray & WH White.

Espresso finish complements the Cordova Brown
 Coastal Gray finish complements the Steely Gray



CB Cordova Brown



SG Steely Gray

**Reception Typical
COSMO4**

Total List: \$7,431.00
 94½"W x 63"D x 41"H
 Includes: RCN6331, RCN3131C & RCN32ADA
 Excludes Accessories



Some items in this collection come ready-to-assemble.



**Reception Typical
COSMO5**

Total List: \$13,877.00
126"W x 94½"D x 41"H
Excludes Seating & Accessories

COSMO5 | Components

SKU #	QTY	DESCRIPTION	W x D x H
RCN6331	2	63" Reception Desk	63 x 31 x 41
RCN3131C	2	Curved Reception Corner	31½ x 31½ x 41
RCN32ADA	1	Reversible ADA Return	31½ x 31½ x 29½



**Reception Typical
COSMO6**

Total List: \$7,175.00
79½"W x 63"D x 41"H
Excludes Seating & Accessories

COSMO6 | Components

SKU #	QTY	DESCRIPTION	W x D x H
RCN4731	1	47" Reception Desk	47 x 31 x 41
RCN3131C	1	Curved Reception Corner	31½ x 31½ x 41
RCN32ADA	1	Reversible ADA Return	31½ x 31½ x 29½



**Reception Typical
COSMO7**

Total List: \$15,669.00
126"W x 79½"D x 41"H
Excludes Seating & Accessories

COSMO7 | Components

SKU #	QTY	DESCRIPTION	W x D x H
RCN4731	2	47" Reception Desk	47 x 31 x 41
RCN3131C	2	Curved Reception Corner	31½ x 31½ x 41
RCN6331	1	63" Reception Desk	63 x 31 x 41



*Design Your Own
with OfficeSource®*

BORDERS II

Configure *Your Way!*

Configurable – Keep it simple with an individual reception desk or combine components to create multi-user desks with panels.

- **Mix & Match** - 24"H Panels can be combined with 12"H panels to make 36"H panels; 12"H panels can be combined by 2's or 3's to create 24"H or 36"H panels
- **Clear Acrylic Panels** - 12"H, 24"H & 36"H; Also 24" & 36"H panels with transaction space.

Privacy Features – Upgrade to whiteboard or fabric tack board panels on divider walls to create more work space off the table top.

Additional Space Options – Add transaction tops to the privacy panel for additional functionality and workspace.

Storage – Customize filing options to maximize your space.

***Stylish** – Choose from 8 rich woodgrain laminate finishes in stock.

Quality Materials – GreenGuard certification means low-emission materials for a healthier office.

**Note: NEW! AE American Elm finish available only for Select SKUs marked with †.*



BORDERS II

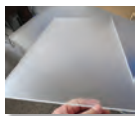

(Frosted)

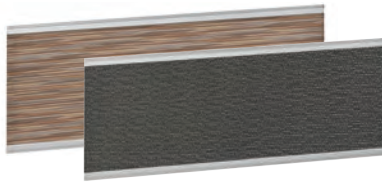

Frosted Acrylic Panels - 12"H

PB21224ACR	24"W x 12"H	\$148.00
PB21230ACR	30"W x 12"H	\$178.00
PB21236ACR	36"W x 12"H	\$221.00
PB21242ACR	42"W x 12"H	\$258.00
PB21248ACR	48"W x 12"H	\$297.00
PB21260ACR	60"W x 12"H	\$354.00
PB21266ACR	66"W x 12"H	\$377.00
PB21271ACR	71"W x 12"H	\$414.00

Fabric Panels - 12"H

PB21224	24"W x 12"H	\$148.00
PB21230	30"W x 12"H	\$162.00
PB21236	36"W x 12"H	\$191.00
PB21248	48"W x 12"H	\$264.00
PB21260	60"W x 12"H	\$324.00
PB21266	66"W x 12"H	\$354.00
PB21271	71"W x 12"H	\$398.00

Note: When ordering panels above, please indicate upholstery option.

White Board Panels - 12"H

PB21230MWB	30"W x 12"H	\$237.00
PB21236MWB	36"W x 12"H	\$251.00

Available In WH White

Optional Clear Acrylic Filler - ¼" Thick

QSACRFILLER24	For 24"H Posts	\$267.00
QSACRFILLER36	For 36"H Posts	\$267.00

Available In SI Silver



(Clear)



(Clear)



(Clear)

Clear Acrylic Panels - 12"H

QSCAB21224	24"W x 12"H	\$374.00
QSCAB21230	30"W x 12"H	\$453.00
QSCAB21236	36"W x 12"H	\$556.00
QSCAB21248	48"W x 12"H	\$688.00
QSCAB21260	60"W x 12"H	\$951.00
QSCAB21266	66"W x 12"H	\$1,013.00
QSCAB21272	71"W x 12"H	\$1,136.00

Clear Acrylic Panels - 24"H

QSCAB2424	24"W x 24"H	\$439.00
QSCAB2430	30"W x 24"H	\$526.00
QSCAB2436	36"W x 24"H	\$637.00
QSCAB2442	42"W x 24"H	\$718.00
QSCAB2448	48"W x 24"H	\$859.00
QSCAB2460	60"W x 24"H	\$1,097.00
QSCAB2466	66"W x 24"H	\$1,286.00
QSCAB2472	71"W x 24"H	\$1,449.00

Clear Acrylic Panels - 36"H

QSCAB3624	24"W x 36"H	\$439.00
QSCAB3630	30"W x 36"H	\$526.00
QSCAB3636	36"W x 36"H	\$637.00
QSCAB3642	42"W x 36"H	\$754.00
QSCAB3648	48"W x 36"H	\$887.00
QSCAB3660	60"W x 36"H	\$1,097.00



Rectangular Transaction Top

PBTR30	30"W x 12"D	\$201.00
PBTR36	36"W x 12"D	\$251.00
PBTR48	48"W x 12"D	\$265.00
PBTR60	60"W x 12"D	\$295.00
PBTR66	66"W x 12"D	\$311.00
PBTR71	71"W x 12"D	\$326.00

Available In CG Coastal Gray & ES Espresso

Corner Transaction Top

PBTC30L (Left)	30"W x 12"D	\$222.00
PBTC30R (Right)	30"W x 12"D	\$222.00
PBTC36L (Left)	36"W x 12"D	\$265.00
PBTC36R (Right)	36"W x 12"D	\$265.00
PBTC66L (Left)	66"W x 12"D	\$326.00
PBTC66R (Right)	66"W x 12"D	\$326.00
PBTC71L (Left)	71"W x 12"D	\$341.00
PBTC71R (Right)	71"W x 12"D	\$341.00

Available In CG Coastal Gray & ES Espresso

Transaction Top Finishes



CG Coastal Gray



ES Espresso

QS = QUICKSHIP

REQUIRED SUPPORTS

Panel Posts

PBP12	12" Post	\$163.00
PBP24	24" Post	\$251.00
PBP36	36" Post	\$417.00

Note: 24"H Panels can be stacked on top of 12" panels to create 36"H panels. 12"H panels can be stacked 2 or 3 inches high.

Available In SI Silver



OPTIONAL BRACKETS

Used for temporary mounting of panels on work surfaces. Also, works for non-OS Laminate application.

Offset Clamp Mount (Set of 2)
PBPOCLMPPR \$65.00 ea.

Post Plate Mount
PBPPATE \$28.00 ea.

Available In SI Silver



Frames & Posts



SI Silver

BORDERS II

Clear Acrylic Panels w/Transaction Spacing

(For Use With 24"H Posts - ¼" Thick)

QSCABTS2424	24"W x 24"H	\$439.00
QSCABTS2430	30"W x 24"H	\$526.00
QSCABTS2436	36"W x 24"H	\$637.00
QSCABTS2442	42"W x 24"H	\$718.00
QSCABTS2448	48"W x 24"H	\$858.00
QSCABTS2460	60"W x 24"H	\$1,097.00

Clear Acrylic Panels w/Transaction Spacing

(For Use With 36"H Posts - ¼" Thick)

QSCABTS3624	24"W x 36"H	\$439.00
QSCABTS3630	30"W x 36"H	\$525.00
QSCABTS3636	36"W x 36"H	\$638.00
QSCABTS3642	42"W x 36"H	\$718.00
QSCABTS3648	48"W x 36"H	\$859.00
QSCABTS3660	60"W x 36"H	\$1,189.00

Note: The transaction spacing is 3"H from the top of the table in order to be able to slide papers through underneath the bottom of the screen. Posts sold separately.



Clear Acrylic Panel w/Transaction Spacing



Optional Clear Acrylic Filler

Optional Clear Acrylic Filler - ¼" Thick

QSACRFILLER24	For 24"H Posts	\$267.00
QSACRFILLER36	For 36"H Posts	\$267.00

Available In SI Silver

REQUIRED SUPPORTS

Panel Posts

PBP12	12" Post	\$163.00
PBP24	24" Post	\$251.00
PBP36	36" Post	\$417.00

Note: 24"H Panels can be stacked on top of 12" panels to create 36"H panels. 12"H panels can be stacked 2 or 3 inches high.

Available In SI Silver



OPTIONAL BRACKETS

Used for temporary mounting of panels on work surfaces. Also, works for non-OS Laminate application.

Offset Clamp Mount (Set of 2)

PBPOCLMPPR	\$65.00 ea.
------------	-------------

Post Plate Mount

PBPPLATE	\$28.00 ea.
----------	-------------

Available In SI Silver



Mounting Brackets
Purchase these optional mounting brackets for temporary or mobile applications. Easily attach them to your work surface top



Typical Available In CH Cherry, MH Mahogany, ES Espresso, MA Maple, MW Modern Walnut, CG Coastal Gray, WH White & NEW! AE American Elm.

QSOSB27 | Components

SKU #	QTY	DESCRIPTION	W x D x H
PL103†	1	Desk Shell	60 x 30 x 29½
PL145†	1	Reversible Return	47 x 24 x 29½
PL107†	1	Hanging 3/4 Pedestal - B/F	15½ x 22 x 19
PBP24	6	Posts	1¾ x 1¾ x 24
QSCABTS2460	1	Clear Acrylic w/Transaction Space	60 x ¼ x 24
QSCABTS2430	2	Clear Acrylic w/Transaction Space	30 x ¼ x 24
QSCABTS2448	1	Clear Acrylic w/Transaction Space	48 x ¼ x 24
PBPOCLMPPR	1	Offset Clamp Mount (Set of 2)	
PBPPLATE	6	Post Plate Mount	
QSACRFILLER24	1	Clear Acrylic Filler	2½ x ¼ x 24

QS = QUICKSHIP

L Shape Typical

QSOSB27†

Total List: \$6,556.00

60"W x 77"D x 54"H

Solid Fabric Panels

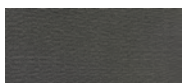

GR Cool Gray



VS Visconti

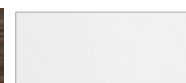

Acrylic or White Board

Transaction Top Finishes



CG Coastal Gray



ES Espresso

Frames & Posts



SI Silver

Note: American Elm only available for select SKUs. Select SKUs are notated by a † mark at the end of their SKU.



Multi-Person Typical
OSB22†
 Total List: \$17,659.00
 120"W x 60"D x 53½"H
 Excludes Seating & Accessories
 Pictured w/Tre Lite Seating

BORDERS II



OSB21 | Components

SKU #	QTY	DESCRIPTION	W x D x H
PL105†	1	Desk Shell	71 x 30 x 29½
PL145†	1	Reversible Return	47 x 24 x 29½
PL166†	1	Deluxe Full Pedestal - B/B/F	15½ x 22 x 28½
PBTR71	1	Rectangular Transaction Top	71 x 12 x 1
PBP12	8	Posts	1¾ x 1¾ x 12
PB21236ACR	2	Acrylic Panels	36 x ¾ x 12
PB21230ACR	2	Acrylic Panels	30 x ¾ x 12
PB21248ACR	1	Acrylic Panel	48 x ¾ x 12
PLTFB	2	Flat Bracket	

OSB21 available in ES Espresso & CG Coastal Gray Only.

Reception Typical OSB21

Total List: \$4,704.00
 71"W x 83"D x 42"H
 Excludes Seating & Accessories
 Pictured w/Crusader Seating
 Transaction Top Only In CG or ES

QSOSB22 | Components

SKU #	QTY	DESCRIPTION	W x D x H
CPSBF	4	Mobile Metal Pedestal	15 x 22 x 22¼
CUSH1522	4	Pedestal Top Cushion	15¼ x 22½ x 1¾
PLTULEG60	3	Unite Leg Base	For (2) 30"D Tops
PLTCBBSINGLE	8	Connector Beam Bracket	
PLT3060†	4	Rectangular Top	60 x 30 x 1
PLTADJMDB4872	4	Adjustable Beam	67¾ x 2 x 1
PBP24	13	Posts	1¾ x 1¾ x 24
QSCABTS2430	6	Clear Acrylic w/Transaction Space	30 x ¼ x 24
QSCABTS2460	2	Clear Acrylic w/Transaction Space	60 x ¼ x 24
QSACRFILLER24	4	Clear Acrylic Filler	2½ x ¼ x 24

QS = QUICKSHIP

Standard Pull Options

Customize Your Pull Options - See Page 35



NEW! AE American Elm w/Silver Pulls
 (†Select SKUs)

CG Coastal Gray w/Silver Pulls

ES Espresso w/Silver Pulls



MW Modern Walnut w/Silver Pulls

MH Mahogany w/Black Pulls

CH Cherry w/Black Pulls

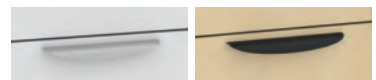

WH White w/Silver Pulls

MA Maple w/Black Pulls

Note: American Elm **only** available for select SKUs. Select SKUs are notated by a † mark at the end of their SKU.



Reception Typical OSB16
 Total List: \$6,296.00
 83"W x 89"D x 42"H
 Excludes Seating & Accessories
 Pictured w/CoolMesh Seating
 Transaction Top Only In CG or ES

BORDERS II



OSB16 | Components

SKU #	QTY	DESCRIPTION	W x D x H
PL145†	2	Reversible Return	47 x 24 x 29½
PL163	1	Corner Desk Shell	36 x 36 x 29½
PL166†	1	Deluxe Full Pedestal - B/B/F	15½ x 22 x 28½
PL175†	1	Deluxe Pedestal Full - F/F	15½ x 22 x 28½
PBP12	8	Posts	1¾ x 1¾ x 12
PB21224ACR	1	Acrylic Panel	24 x ¾ x 12
PB21236ACR	2	Acrylic Panels	36 x ¾ x 12
PB21248ACR	2	Acrylic Panels	48 x ¾ x 12
PBTR36	1	Rectangular Transaction Top	36 x 12 x 1
PBTR48	1	Rectangular Transaction Top	48 x 12 x 1

OSB16 available in ES Espresso & CG Coastal Gray Only.

Standard Pull Options
 Customize Your Pull Options - See Page 35



NEW! AE American Elm w/Silver Pulls
 (†Select SKUs)

CG Coastal Gray w/Silver Pulls

ES Espresso w/Silver Pulls



MW Modern Walnut w/Silver Pulls

MH Mahogany w/Black Pulls

CH Cherry w/Black Pulls



WH White w/Silver Pulls

MA Maple w/Black Pulls

Note: American Elm **only** available for select SKUs. Select SKUs are notated by a † mark at the end of their SKU.

OSB20 | Components

SKU #	QTY	DESCRIPTION	W x D x H
PL105†	1	Desk Shell	71 x 30 x 29½
PL145†	1	Reversible Return	47 x 24 x 29½
PL166†	1	Deluxe Full Pedestal - B/B/F	15½ x 22 x 28½
PBTC30R	1	Corner Transaction Top (Right)	30 x 12 x 1
PBTR48	1	Rectangular Transaction Top	48 x 12 x 1
PBTC71L	1	Corner Transaction Top (Left)	71 x 12 x 1
PBP12	6	Posts	1¾ x 1¾ x 12
PB21271	1	Fabric Panel	71 x ¾ x 12
PB21230	2	Fabric Panels	30 x ¾ x 12
PB21248	1	Fabric Panel	48 x ¾ x 12

OSB20 available in ES Espresso & CG Coastal Gray Only.

Reception Typical OSB20

Total List: \$4,715.00
 77"W x 83½"D x 42½"H
 Excludes Seating & Accessories
 Pictured w/CoolMesh Seating
 Transaction Top Only In CG or ES



BORDERS II

Reception Typical OSB25

Total List: \$9,714.00

114"W x 89"D x 42"H

Excludes Seating & Accessories
Pictured w/Tre Lite & Manhattan Seating
Transaction Top Only In CG or ES

OSB25 | Components

SKU #	QTY	DESCRIPTION	W x D x H
PL145†	2	Reversible Return	47 x 24 x 29½
PL163	2	Corner Desk Shell	36 x 36 x 29½
PL188	1	Bridge	30 x 24 x 29½
PL166†	1	Deluxe Full Pedestal - B/B/F	15½ x 22 x 28½
PL175†	1	Deluxe Pedestal Full - F/F	15½ x 22 x 28½
PBP12	12	Posts	1¾ x 1¾ x 12
PB21230	1	Fabric Panel	30 x ¾ x 12
PB21236	4	Fabric Panels	36 x ¾ x 12
PB21248	2	Fabric Panels	48 x ¾ x 12
PBTR48	2	Rectangular Transaction Top	48 x 12 x 1
PBTR30	1	Rectangular Transaction Top	30 x 12 x 1
PBTC36L	2	Corner Transaction Top - Left	36 x 12 x 1
PBTC36R	2	Corner Transaction Top - Right	36 x 12 x 1

OSB25 available in ES Espresso & CG Coastal Gray Only.

Solid Fabric Panels



GR Cool Gray



VS Visconti

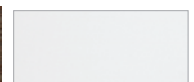

Acrylic or
White Board

Transaction Top Finishes



CG Coastal Gray



ES Espresso

Frames & Posts



SI Silver



OSB09 | Components

SKU #	QTY	DESCRIPTION	W x D x H
PB21236	3	Fabric Panels	36 x ¾ x 12
PB21236MWB	6	White Board Panels	36 x ¾ x 12
PBP12	6	Posts	1¾ x 1¾ x 12
PBP24	5	Posts	1¾ x 1¾ x 24
PL182R†	1	Credenza w/Corner Ext (Right)	71 x 24/36 x 29½
PL182L†	1	Credenza w/Corner Ext (Left)	71 x 24/36 x 29½
PL192†	2	Reversible Return	35 x 24 x 29½
PL166†	2	Deluxe Full Pedestal - B/B/F	15½ x 22 x 28½

Multi-Person Typical OSB09†

Total List: \$8,176.00

142"W x 71"D x 54"H

Excludes Accessories

Typical Available In CH Cherry, MH Mahogany, ES Espresso, MA Maple, MW Modern Walnut, CG Coastal Gray, WH White & NEW! AE American Elm.

Note: American Elm only available for select SKUs. Select SKUs are notated by a † mark at the end of their SKU.



BORDERS II

NEW! Reception Typical

QSOSTYP327†

Total List: \$12,621.00

142"W x 71"D x 53½"H

Excludes Seating, Reception

Tables & Accessories

Pictured w/CoolMesh & Dover Seating

NEW! QSOSTYP327 | Components

SKU #	QTY	DESCRIPTION	W x D x H
PL182R†	1	Credenza w/Corner Ext (Right)	71 x 24/36 x 29½
PL182L†	1	Credenza w/Corner Ext (Left)	71 x 24/36 x 29½
PL192†	2	Reversible Return	35 x 24 x 29½
PL166†	2	Deluxe Full Pedestal - B/B/F	15½ x 22 x 28½
PBP24	10	Posts	1¾ x 1¾ x 24
QSCABTS2436	4	Clear Acrylic w/Transaction Space	36 x ¼ x 24
QSCABTS2472	2	Clear Acrylic w/Transaction Space	71 x ¼ x 24
QSAACRILLER24	3	Clear Acrylic Filler	2½ x ¼ x 24

QS = QUICKSHIP

Standard Pull Options

Customize Your Pull Options - See Page 35



NEW! AE American Elm w/Silver Pulls
(†Select SKUs)



CG Coastal Gray w/Silver Pulls



ES Espresso w/Silver Pulls



MW Modern Walnut w/Silver Pulls



MH Mahogany w/Black Pulls



CH Cherry w/Black Pulls



WH White w/Silver Pulls



MA Maple w/Black Pulls

Note: American Elm **only** available for select SKUs. Select SKUs are notated by a † mark at the end of their SKU.



OSB10 | Components

SKU #	QTY	DESCRIPTION	W x D x H
PB21236	9	Fabric Panels	36 x ¾ x 12
PB21236ACR	6	Acrylic Panels	36 x ¾ x 12
PBP12	2	Posts	1¾ x 1¾ x 12
PBP24	1	Post	1¾ x 1¾ x 24
PBP36	8	Posts	1¾ x 1¾ x 36
PBTR36	1	Rectangular Transaction Top	36 x 12 x 1
PL182R†	1	Credenza w/Corner Ext (Right)	71 x 24/36 x 29½
PL182L†	1	Credenza w/Corner Ext (Left)	71 x 24/36 x 29½
PL192†	2	Reversible Return	35 x 24 x 29½
PL166†	2	Deluxe Full Pedestal - B/B/F	15½ x 22 x 28½
PL160	2	Corner Bookcase	24 x 24 x 30

Multi-Person Typical OSB10

Total List: \$12,505.00

142"W x 95"D x 66"H

Excludes Keyboard System & Accessories

Transaction Top Only In CG or ES

OSB10 available in ES Espresso & CG Coastal Gray Only.

SAFEGUARD BARRIER



Frosted Acrylic Shields

Pictured w/CoolMesh Seating & NEW! OSTYP302 Typical



Fabric Shields

Pictured w/Triumph Seating & NEW! OSTYP312 Typical

Note: OSTYP312 is based on a single desk workstation set-up. For multiple desk units, please double the amount as needed.



Clear Acrylic Shields

Pictured w/CoolMesh Pro Seating & NEW! QSOOSTYP301 Typical

SAFEGUARD BARRIER

STRAIGHT PRIVACY SHIELDS



15" Fabric Shields

- 1/2"D x 15"H (Desk Top Mountable)

PLTFP1524	24" Wide	\$183.00
PLTFP1530	30" Wide	\$183.00
PLTFP1536	36" Wide	\$196.00
PLTFP1548	48" Wide	\$255.00
PLTFP1554	54" Wide	\$285.00
PLTFP1566	66" Wide	\$323.00



BL Celestial Blue

GK Dark Gray



15" Frosted Acrylic Shields

- 1/4"D x 15"H (Desk Top & Under Desk Mountable)

PLTAP1524S	24" Wide	\$239.00
PLTAP1530S	30" Wide	\$239.00
PLTAP1536S	36" Wide	\$254.00
PLTAP1542S	42" Wide	\$290.00
PLTAP1548S	48" Wide	\$313.00
PLTAP1554S	54" Wide	\$341.00
PLTAP1566S	66" Wide	\$357.00

Available In FR Frosted Acrylic

Note: Frosted Acrylic Shields come with rounded corners & are 1/4" thick.



24" Frosted Acrylic Shields

- 1/4"D x 24"H (Desk Top Mountable)

PLTAP2424S	24" Wide	\$261.00
PLTAP2430S	30" Wide	\$288.00
PLTAP2436S	36" Wide	\$345.00
PLTAP2442S	42" Wide	\$408.00
PLTAP2448S	48" Wide	\$450.00
PLTAP2454S	54" Wide	\$470.00
PLTAP2466S	66" Wide	\$575.00

Available In FR Frosted Acrylic



Note: The transaction spacing for shields using the FLAT brackets is 3/8"H from the top of the table to be able to slide paper underneath.

Shield Brackets
See Page 97

CLEAR ACRYLIC SHIELDS

15" Clear Acrylic Shields

- 1/4"D x 15"H (Desk Top Mountable)

QSACRV1524C	24" Wide	\$196.00
QSACRV1530C	30" Wide	\$216.00
QSACRV1536C	36" Wide	\$259.00
QSACRV1542C	42" Wide	\$267.00
QSACRV1548C	48" Wide	\$299.00
QSACRV1554C	54" Wide	\$324.00
QSACRV1560C	60" Wide	\$345.00
QSACRV1566C	66" Wide	\$382.00
QSACRV1572C	72" Wide	\$397.00

Note: Clear Acrylic Shields come with square corners & are 1/4" thick.

24" Clear Acrylic Shields

- 1/4"D x 24"H (Desk Top Mountable)

QSACRV2424C	24" Wide	\$232.00
QSACRV2430C	30" Wide	\$267.00
QSACRV2436C	36" Wide	\$335.00
QSACRV2442C	42" Wide	\$359.00
QSACRV2448C	48" Wide	\$411.00
QSACRV2454C	54" Wide	\$472.00
QSACRV2460C	60" Wide	\$513.00
QSACRV2466C	66" Wide	\$564.00
QSACRV2472C	72" Wide	\$616.00

Available In CL Clear Acrylic

30" Clear Acrylic Shields

- 1/4"D x 30"H (Desk Top Mountable)

QSACRV3024C	24" Wide	\$282.00
QSACRV3030C	30" Wide	\$335.00
QSACRV3036C	36" Wide	\$411.00
QSACRV3042C	42" Wide	\$463.00
QSACRV3048C	48" Wide	\$513.00
QSACRV3054C	54" Wide	\$564.00
QSACRV3060C	60" Wide	\$642.00
QSACRV3066C	66" Wide	\$693.00
QSACRV3072C	72" Wide	\$745.00

Available In CL Clear Acrylic **QS = QUICKSHIP**

Cleaning Instructions:
Acrylic can be safely cleaned and disinfected with most non-abrasive cleaners such as:

- Disinfecting Wipes
- Disinfectant Sprays
- Some Multi-Surface Cleaners (Check Labels)
- Mild Soaps

CLEAR ACRYLIC SHIELDS W/CUT-OUT

24" Clear Acrylic Shields

w/Optional Cut-Out - 1/4"D x 24"H

QSACRV2424CCO	24" Wide	\$319.00
QSACRV2430CCO	30" Wide	\$356.00
QSACRV2436CCO	36" Wide	\$422.00
QSACRV2442CCO	42" Wide	\$448.00
QSACRV2448CCO	48" Wide	\$498.00
QSACRV2454CCO	54" Wide	\$560.00
QSACRV2460CCO	60" Wide	\$601.00
QSACRV2466CCO	66" Wide	\$653.00
QSACRV2472CCO	72" Wide	\$704.00

30" Clear Acrylic Shields

w/Optional Cut-Out - 1/4"D x 30"H

QSACRV3024CCO	24" Wide	\$371.00
QSACRV3030CCO	30" Wide	\$422.00
QSACRV3036CCO	36" Wide	\$498.00
QSACRV3042CCO	42" Wide	\$549.00
QSACRV3048CCO	48" Wide	\$601.00
QSACRV3054CCO	54" Wide	\$653.00
QSACRV3060CCO	60" Wide	\$729.00
QSACRV3066CCO	66" Wide	\$780.00
QSACRV3072CCO	72" Wide	\$832.00

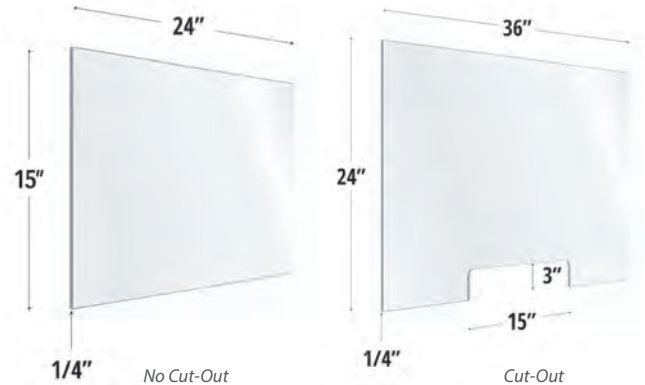

TWO TIER SHIELD W/FOOT

Clear Acrylic/Laminate

Two Tier Shield

LHI6153L

23 3/8"W x 60 1/4"D x 51 5/8"H

List: \$942.00



DB Distressed Brown



Pictured w/Tre Seating

SAFEGUARD BARRIER

SHIELD BRACKETS - FOR FABRIC & ACRYLIC PANELS

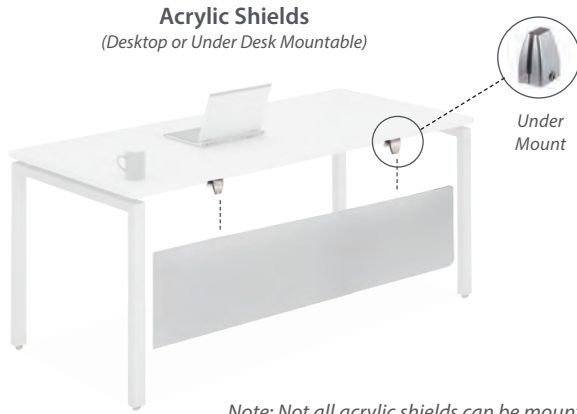

Note: Not all acrylic shields can be mounted under desk tops.

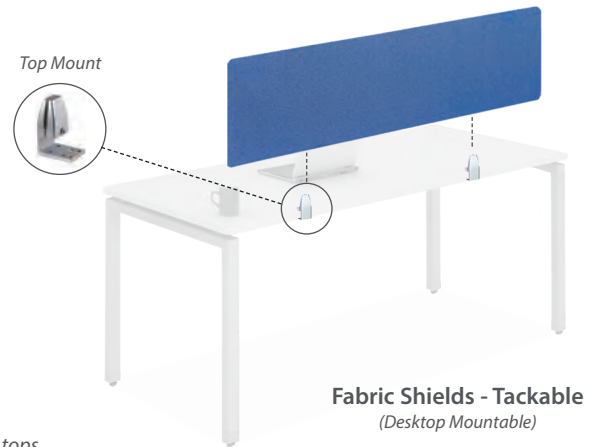

FABRIC & ACRYLIC SHIELD BRACKETS



Desk Mount Bracket
(Mounts to Desk Top)
OSTB400 (Silver Only)
List: \$37.00 ea.



Under Desk Mount Bracket
(Set of 2 - Mounts to 1" Work Surface)
PLTSBUDMSGL
List: \$94.00
Note: Requires work surface overhang.



Dual Under Desk Mount Bracket
(Set of 2 - Mounts Between Work Surfaces)
PLTSBUDMDUAL
List: \$128.00
Note: Requires work surface overhang.



Note: Fabric & Acrylic Brackets can be shipped by a small package carrier.

TEMPORARY SHIELD BRACKETS



Work Surface Clamp Bracket
(For 1-1½" Thick Tops)
OSCLMB
List: \$102.00 ea.

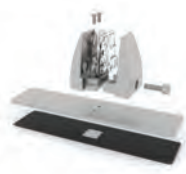

Free-Standing Panel Foot
OSFSPB
List: \$89.00 ea.

Note: These brackets include an anti-slip, textured bottom to prevent movement when mounted to desk top surface.

Note: Temporary Brackets can be shipped by a small package carrier.



SHIELD STABILIZER BRACKETS

Acrylic Stabilizer Brackets can be used on the top or bottom of acrylic shields to connect multiple shields together for added stability.



Corner Bracket
OSSSL
List: \$56.00 ea.



Straight Bracket
OSSS
List: \$51.00 ea.



X-Shaped Bracket
OSSSX
List: \$70.00 ea.



T-Shaped Bracket
OSSST
List: \$66.00 ea.



Note: Stabilizer Brackets can be shipped by a small package carrier.



OS PANELS

OS Panel Systems

Panel Systems Detail

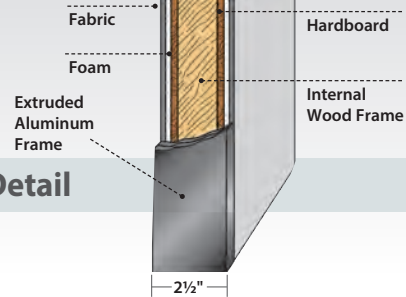

Explore the endless possibilities of configuring your office space through the use of office partitions, office dividers and panel systems. We do not align ourselves with one exclusive panel manufacturer, but distribute the products of several manufacturers, allowing our sales professionals to offer our customers more options at better pricing. View our gallery of office partitions to see how partitions and panels can transform your office into a functional, practical and stylish environment.



PANELS

A Upholstered Panels

SP4224	24"W x 42"H	\$407.00
SP4230	30"W x 42"H	\$436.00
SP4236	36"W x 42"H	\$491.00
SP6624	24"W x 66"H	\$492.00
SP6630	30"W x 66"H	\$549.00
SP6636	36"W x 66"H	\$593.00
SP6648	48"W x 66"H	\$725.00
SP6660	60"W x 66"H	\$844.00
SP6672	72"W x 66"H	\$999.00

B Opaque View-Through Panels

SPG6624	24"W x 66"H	\$584.00
SPG6630	30"W x 66"H	\$640.00
SPG6636	36"W x 66"H	\$725.00

Note: Freestanding panels require end caps.

FEATURES

- Easily create a functional & productive workspace with the use of office partitions
- Durable, pewter fabric upholstery with a 2 1/2" extruded aluminum external frame in a charcoal finish
- Panel systems include cubicle panels
- Ready-to-assemble

ADDITIONAL ACCESSORIES

SP242	2 Way Corner connector 42"	\$107.00
SP266	2 Way Corner connector 66"	\$149.00
SP342	3 Way T connector 42"	\$137.00
SP366	3 Way T connector 66"	\$190.00
SP442	4 Way + connector 42"	\$142.00
SP466	4 Way + connector 66"	\$198.00
SPPG24	24" Filler For 42" to 66"	\$52.00
SPCAP24	End Cap 24"	\$38.00
SPCAP42	End Cap 42"	\$52.00
SPCAP66	End Cap 66"	\$65.00

Note: SPPG24 is a filler piece when using a 3-way connector & dropping from 66" to 42" panels.

SPBASE1	Support Foot	\$79.00
SPWM42	Wall Mount Kit 42"	\$101.00
SPWM66	Wall Mount Kit 66"	\$136.00
SPTB	Tie Bracket for Stabilizing Straight Run of Panels	\$14.00



Tie Bracket



Support Foot



Wall Mount Kit



End Cap 24"

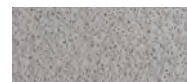

PW Pewter Fabric w/CR Charcoal Frame

Note: All accessories on this page can be shipped by a small package carrier. 📦



Panel System 8 (Panels Only)
 Total List: \$16,062.00
Complete Package 8† (w/Desks)
 Total List: \$33,720.00
 Excludes Seating & Accessories
 Pictured w/Triumph & Cade Seating

OS PANELS

COMPLETE PACKAGE 8 | Components

SKU #	QTY	DESCRIPTION	W x D x H
PL178L†	3	Desk w/Corner Extension - Lt	71 x 23½/42x 29½
PL178R†	3	Desk w/Corner Extension - Rt	71 x 23½/42x 29½
PL179†	6	Reversible Return	30 x 24 x 29½
PL166†	6	Deluxe Full Pedestal - B/B/F	15½ x 22 x 28½
PL175†	6	Deluxe Full Pedestal - F/F	15½ x 22 x 28½
SP366	3	3 Way T Connector	
SP6672	6	Upholstered Panels	72 x 2½ x 66
SPWM66	3	Wall Mount	
SPCAP66	6	End Cap 66"	
SPG6636	12	Opaque View-Through Panels	36 x 2½ x 66

Note: Panel System 8 lists left hand/top side of image only - double for complete room.

Note: American Elm only available for select SKUs.
 Select SKUs are notated by a † mark at the end of their SKU.

COMPLETE PACKAGE 1 | Components

SKU #	QTY	DESCRIPTION	W x D x H
PL1012†	1	2 Drawer Personal Cabinet	35½ x 22 x 22
PL2013†	1	Open Shelf Cabinet	35½ x 22 x 22
PL110†	1	Credenza Top	71 x 22 x 1
PL1044OH†	1	Open Hutch	71 x 15 x 17
PL44LD†	1	Laminate Doors (Sets of 2)	17 x ¾ x 15¾
PLTLPHS20	1	Hutch Supports (Pair)	14 x 2 x 20
PLT2472†	2	Rectangular Top	72 x 24 x 1
PLTDR2430	1	Desk Riser	23¾ x 6½ x 2
PLTULEG24	3	Unite Leg	23¾ x 2 x 28½
PLTADJMDB4872	2	Adjustable Beam	67¾ x 2 x 1
PLTCBBSINGLE	3	Connector Beam Bracket	
PL207†	1	Wardrobe Storage Unit	24¼ x 23¾ x 65½
SP6624	3	Upholstered Panels	24 x 2½ x 66
SP6672	1	Upholstered Panels	72 x 2½ x 66
SPG6636	4	Opaque View-Through Panels	36 x 2½ x 66
SP266	3	2 Way Corner Connector	
SPCAP66	2	End Cap 66"	



Panel System 1 (Panels Only)
 Total List: \$5,952.00
Complete Package 1† (w/Desks)
 Total List: \$14,942.00
 Excludes Accessories



PW Pewter Fabric
 w/CR Charcoal Frame



Panel System 6 (Panels Only)
 Total List: \$10,868.00
Complete Package 6† (w/Desks)
 Total List: \$41,668.00
 Excludes Accessories

OS PANELS



COMPLETE PACKAGE 6 | Components

SKU #	QTY	DESCRIPTION	W x D x H
PLT3072†	4	Rectangular Top	72 x 30 x 1
PL1012†	4	2 Drawer Personal Cabinet	35½ x 22 x 22
PL2013†	4	Open Shelf Cabinet	35½ x 22 x 22
PL110†	4	Credenza Top	71 x 22 x 1
PL207†	4	Wardrobe Storage Unit	24¼ x 23¾ x 65½
SP6648	2	Upholstered Panels	48 x 2½ x 66
SP6636	2	Upholstered Panels	36 x 2½ x 66
SP4236	12	Upholstered Panels	36 x 2½ x 42
SPG6636	2	Opaque View-Through Panels	36 x 2½ x 66
SP366	2	3 Way T Connector	
SP466	1	4 Way T Connector	
SPCAP42	6	End Cap 42"	
PLTHATFEET30	4	Standard Feet (Set of 2)	23¾ x 3¾ x 1½
PLTEAB4872ECONF	4	3-Stage Electric Base	46%-70¼ x 23¾-29½ x 24¾-50

Note: American Elm **only** available for select SKUs.
 Select SKUs are notated by a † mark at the end of their SKU.

COMPLETE PACKAGE 7 | Components

SKU #	QTY	DESCRIPTION	W x D x H
PL183†	7	Three Drawer Lateral File	35½ x 22 x 42
PL109†	7	File/Credenza Top	35½ x 22 x 1
PL166†	4	Deluxe Full Pedestal - B/B/F	15½ x 22 x 28½
PLTULEG24	4	Unite Leg	23¾ x 2 x 28½
PLT2472†	4	Rectangular Top	72 x 24 x 1
PLTRETSSUPPORT	4	Return Bracket	
SP4224	4	Upholstered Panels	24 x 2½ x 42
SP4236	5	Upholstered Panels	36 x 2½ x 42
SP342	2	3 Way T Connector 42"	
SPCAP42	4	End Cap 42"	
PLTCBBSINGLE	4	Connector Beam Bracket	

Panel System 7 (Panels Only)
 Total List: \$4,565.00
Complete Package 7† (w/Desks)
 Total List: \$33,306.00
 Excludes Accessories



PW Pewter Fabric
 w/CR Charcoal Frame

Note: PL109 is available in **NEW!** AE American Elm, ES Espresso, MW Modern Walnut, CG Coastal Gray & WH White Only.



OS PANELS

Panel System 9 (Panels Only)
 Total List: \$7,034.00
Complete Package 9† (w/Desks)
 Total List: \$10,898.00
 Excludes Accessories



COMPLETE PACKAGE 9 | Components

SKU #	QTY	DESCRIPTION	W x D x H
PL182R†	1	Credenza w/Corner Ext (Rt)	71 x 24/36 x 29½
PL182L†	1	Credenza w/Corner Ext (Lt)	71 x 24/36 x 29½
PL192†	2	Reversible Return	35 x 24 x 29½
PL166†	2	Deluxe Full Pedestal - B/B/F	15½ x 22 x 28½
SPG6636	6	Opaque View-Through Panels	36 x 2½ x 66
SP4236	4	Upholstered Panels	36 x 2½ x 42
SP266	2	2 Way Corner Connector 66"	
SP366	1	3 Way T Connector 66"	
SPCAP42	3	End Cap 42"	
SPCAP24	2	End Cap 24"	

Note: Panel System 9 is based on a 1 x 2 person pod.

Note: American Elm **only** available for select SKUs.
 Select SKUs are notated by a † mark at the end of their SKU.

COMPLETE PACKAGE 10 | Components

SKU #	QTY	DESCRIPTION	W x D x H
PL182R†	2	Credenza w/Corner Ext (Rt)	71 x 24/36 x 29½
PL182L†	2	Credenza w/Corner Ext (Lt)	71 x 24/36 x 29½
PL192†	4	Reversible Return	35 x 24 x 29½
PL166†	4	Deluxe Full Pedestal - B/B/F	15½ x 22 x 28½
SPG6636	8	Opaque View-Through Panels	36 x 2½ x 66
SP4236	8	Upholstered Panels	36 x 2½ x 42
SP366	2	3 Way T Connector 66"	
SP466	1	4 Way T Connector 66"	
SPCAP42	6	End Cap 42"	
SPCAP24	4	End Cap 24"	

Panel System 10 (Panels Only)
 Total List: \$10,770.00
Complete Package 10† (w/Desks)
 Total List: \$18,498.00
 Excludes Accessories

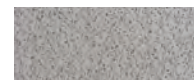

PW Pewter Fabric
 w/CR Charcoal Frame



A Magnetic Steel Dry-Erase Board with Aluminum Frame
 – Magnetic, steel surface dry-erase boards with a professional aluminum frame that comes with a 4-Corner mounting system. These can be mounted vertically or horizontally. These boards feature a 10-Year Surface Warranty.



B Magnetic Glass Dry-Erase Board
 – High-quality, magnetic glass dry-erase board surface made with tempered glass for safer use with a 4mm thickness and water resistant. These boards feature a Lifetime Limited Warranty.

A. Magnetic Steel Dry-Erase Board with Aluminum Frame				
OS05071MS	WH White	36"W x 48"H	7 lbs	\$405.00
OS21071MS	WH White	48"W x 96"H	19 lbs	\$1,057.00
OS27071MS	WH White	48"W x 72"H	14 lbs	\$795.00
B. Magnetic Glass Dry-Erase Board				
QSOSL0701MG	WH White	24"W x 36"H	14 lbs	\$414.00
OS0801MG	WH White	36"W x 48"H	29 lbs	\$767.00
OS1201MG	WH White	48"W x 72"H	57 lbs	\$1,603.00
OS2501MG	WH White	48"W x 96"H	93 lbs	\$2,233.00
C. Double-Sided Dry-Erase Mobile Revolving Easel with Silver Frame				
OSR5507MD	WH White	48"W x 72"H	86 lbs	\$3,989.00



C Double-Sided Dry-Erase Mobile Revolving Easel
 – Magnetic, steel surface on both sides of the easel with a steel, tubular frame and support bars that makes it one of the most stable mobile easels in the marketplace. These boards feature a 10-Year Surface Warranty. Ready to Assemble.

DRY-ERASE BOARD FEATURES



Porcelain boards come with a snap-on aluminum pen tray for easy accessory storage



Glass boards come with square corners with a pass-through mounting hardware

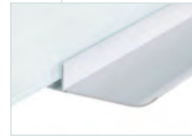

Magnets, pen tray and wall mounting hardware is all included with glass boards

MOBILE EASEL FEATURES



Pen and accessory tray can be repositioned easily for whatever is more comfortable and efficient for you



Adjustable, easel pad clips will virtually hold any size easel in place easily & an easel pad that stands at 80" x 24"D.

Note: OSL0701MG, OS05071MS & OS0801MG on this page can be shipped by a small package carrier. 📦

QS = QUICKSHIP

NEW! VIZUAL



Magnetic Glass Revolver & Mobile Easel

– Magnetic, high-quality glass surface that never ghosts, cleans easily, and is perfect for extensive use over time. The opaque white magnetic surface allows you to use the boards for posting or writing with a heavy-duty chrome stand and locking casters. Polished stainless steel pen tray is included. These boards feature a Lifetime Surface Warranty.

D. NEW! Magnetic Glass Mobile Easel with Chrome Frame				
QSOS4850MG	WH White	30"W x 42"H	79 lbs	\$5,000.00
E. NEW! Magnetic Glass Revolver with Chrome Frame				
QSOS0450MG	WH White	48"W x 60"H	133 lbs	\$6,700.00

Note: OS4850MG on this page can be shipped by a small package carrier. 📦 **QS = QUICKSHIP**

FEATURES

- Surfaces are suitable for frequent and extensive use
- Ghost and scratch-resistant
- Porcelain and glass clean easily with very little maintenance involved with mild soap and warm water
- High-quality, durable surfaces and frames
- Lifetime Limited Warranty available on all boards



MOBILE GLASS EASEL FEATURES



Magnetic surface doesn't stain or ghost with a tempered glass that is 4mm thick



Includes (2) extension arms for displaying easel pads that tuck away when not in use



Heavy-duty, 5-Star chrome base with locking casters & adjusts from 67"-75" tall

GLASS REVOLVER FEATURES



Double-sided magnetic surface allows you to post notes or charts with a polished stainless steel pen tray included



Rounded corners with beveled edges and an opaque white glass that prevents show-through



Stunning, polished chrome frame with (4) locking casters that are suitable for extensive use all day



Pictured w/NEW! Oslo Armless Guest Seating & NEW! OSTYP320 Typical

OS TRAINING TABLES

Your Table, Your Way!

Build Your Custom Table...

Training Tables by OfficeSource® provide convenience and flexibility to any workstation, whether it be in a work environment or a classroom. These Training Tables by OfficeSource® feature 7 base options, several top sizes, and 8 finishes giving you the ability to configure them your way! Not only are these tables super customizable, but they also have such a simple yet sophisticated style to them that they can match any space.

Configure *Your Way!*



Improved Folding Lever



Flip Top, Nesting



Pictured w/Fabric Panels & Triumph Seating & multiples of NEW! OSTYP312 Typical



Pictured w/Julop Seating & OST08 Typical

Eight Top Finishes | Several Top Sizes | Seven Base Options

OS TRAINING TABLES

Custom Build Your Training Or Multi-Purpose Table By Combining Table Tops & Bases

TRAINING TABLE BASES

Seven different options to choose from. See Page 106 for details.



Flip Top Nesting
Base - Style 1
(Modesty Panel Included)
(Locking Casters Included)



Flip Top Nesting
Base - Style 2
(Locking Casters Included)



Flip Top Nesting Adjustable Width
Base - Style 3
(Locking & Leveling Capable Casters Included)

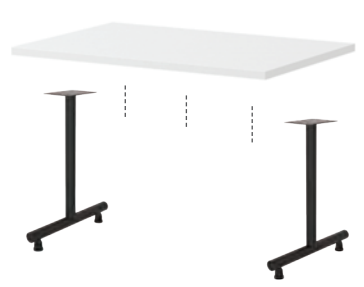

"T" Leg Base w/Standard Glides
Base - Style 4



Nesting



Nesting



Nesting

OPTIONAL CASTERS

(For T, Post & Unite Height Adj. Leg Bases)
(See Page 106)



(Set of 2)



Offset Square Leg Base
Base - Style 5



Post Leg Base
Base - Style 6



Unite Height Adjustable Leg Base
Base - Style 7

RECTANGULAR TOP & SEVERAL SIZES

Rectangular top shape, several different sizes & eight top finishes to choose from. See Page 107 for details.



Rectangular Top
(Compatible w/All Bases)



NEW! American Elm Finish
(Shown in PLT2448)



Accessories
(See Pages 106-107)



Ganging Hardware

Laminate Top Finishes

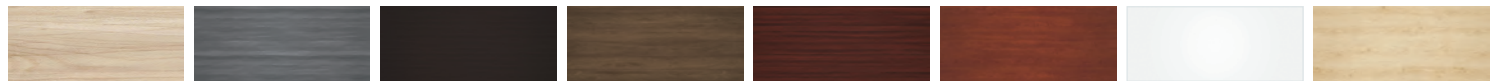

NEW! AE American Elm
(†Select SKUs)

CG Coastal Gray

ES Espresso

MW Modern Walnut

MH Mahogany

CH Cherry

WH White

MA Maple

Note: American Elm **only** available for select SKUs. Select SKUs are notated by a † mark at the end of their SKU.

Metal Base Finishes



BK Black

SI Silver

WH White
(Select SKUs)

OS TRAINING TABLES



Available In BK Black & SI Silver



Available In BK Black, SI Silver & WH White



Available In BK Black & SI Silver



Available In BK Black & SI Silver

Optional Locking Casters Available for "T" Leg

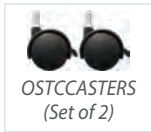

OSTCCASTERS (Set of 2)



Available In BK Black & SI Silver



Available In BK Black & SI Silver

Posts Legs Available With Glides or Casters Included

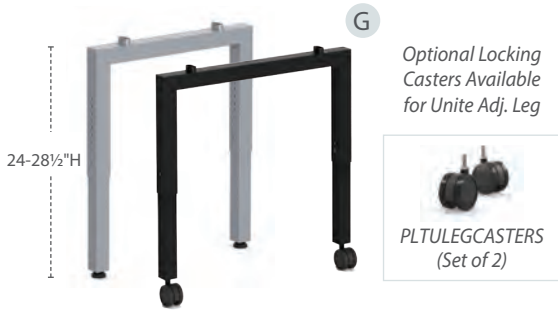

Available In BK Black & SI Silver

Optional Locking Casters Available for Unite Adj. Leg



PLTULEGCASTERS (Set of 2)



Flip Top Nesting Base - Style 1 Includes Modesty Panel for Wire Management & Privacy

- A Flip Top, Nesting Base - Style 1**
PBF48 (For PLT2448 Tops) \$543.00 ea.
PBF60 (For PLT2460 Tops) \$614.00 ea.
PBF72 (For PLT2472 Tops) \$662.00 ea.

- B Flip Top, Nesting Base - Style 2**
PTLF60* (For 60"W Tops) \$821.00 ea.
PTLF72* (For 72"W Tops) \$869.00 ea.

- C Flip Top, Adj. Width Base - Style 3**
FTHAB4872 (48"-72"W - Adj.) \$796.00 ea.

- D "T" Leg Base - Style 4**
OSTLEG24 (For 24"D Tops) \$458.00 ctn.
OSTLEG30 (For 30"D Tops) \$492.00 ctn.
 Note: "T" Leg Base Priced (2) Per Carton.

- E Offset Square Leg Base - Style 5**
PLTSQPOSTLEG (For All Tops) \$253.00 ctn.
 Note: Priced and sold as (2) per carton.

- F Post Leg Base - Style 6**
OSPOST28C (With Casters) \$144.00 ctn.
OSPOST28G (With Glides) \$142.00 ctn.
 Note: Post Leg Base Priced (2) Per Carton.

- G Unite Adj. Height Leg Base - Style 7**
PLTULEG2485H (For 24"D Tops) \$362.00 ea.
 Note: Adj. Height Legs Require Brackets & Beams (See Page 119)

Metal Base Finishes



OPTIONAL HARDWARE & ACCESSORIES

- 60" Stiffener Support** (For Tops 60" or larger)
PLT60MSBK* List: \$112.00 ctn.
- 72" Stiffener Support** (For Tops 72" or larger)
PLT72MSBK* List: \$140.00 ctn.

*Note: Tops 60" Or Larger Require the Purchase of Stiffener Bars when using Base Styles 4, 5 & 6. (PLT60MS or PLT72MS - Stiffeners Come In Set of 2).

Note: PLT60MS & PLT72MS Priced (2) Per Carton.

- Flat Bracket**
PLTFBBK List: \$28.00 ea.



- Ganging Hardware**
PLTGCBK List: \$70.00 ea.



- Optional Casters** (For "T" Leg Bases - Set of 2)
OSTCCASTERSBK List: \$40.00 ea.

Note: Must order (1) Set Per Leg.

- Optional Casters** (For Unite Adj. Leg Base - Set of 2)
PLTULEGCASTERSBK List: \$65.00 ea.

Note: FTHAB4872, OSPOST28C, OSPOST28G, PLTFB, PLTGC, PLTULEGCASTERS & OSTCCASTERS can be shipped by a small package carrier.



**Training Typical - Style 7
OST22†**
 Total List: \$6,360.00
 72"W x 24"D x 25-29½"H
 Excludes Seating & Accessories
 Pictured w/Triumph Seating

OS TRAINING TABLES

OST22 | Components

SKU #	QTY	DESCRIPTION	W x D x H
PLT2472†	4	Rectangular Top	72 x 24 x 1
PLTULEG2485H	8	Unite Adj. Height Leg Base	63¼ x 20½ x 24-28½
PLTADJMDB4872	4	Adjustable Beam	67¾ x 2 x 1
PLTCBBSINGLE	8	Connector Beam Bracket	
PLTULEGCASTERS	8	Set of Casters - (Set of 2)	

Adjustable Legs

Adjustable
24-28½"H

w/Optional
Casters

Note: Adj. Height Legs Require Brackets & Beams. (See Page 119)



Rectangular Tops

PLT2448†	48"W x 24"D	\$360.00
PLT2460†	60"W x 24"D	\$405.00
PLT2466†	66"W x 24"D	\$443.00
PLT2472†	72"W x 24"D	\$443.00
PLT3048†	48"W x 30"D	\$393.00
PLT3060†	60"W x 30"D	\$487.00
PLT3066†	66"W x 30"D	\$519.00
PLT3072†	72"W x 30"D	\$519.00
PLT3672†	72"W x 36"D	\$628.00



PTLFMOD72 Shown w/PTLF72

OPTIONAL MODESTY PANELS



(Includes Brackets)

Metal Perforated Modesty Panels - 15"H

(18"H w/Included Brackets)

MMP1853 (For 60"W Tops) \$183.00

MMP1865 (For 72"W Tops) \$213.00

Available In SI Silver, BK Matte Black

Note: Metal Modesty Panels are for "T", Post, Unite Height Adjustable & Square Leg Bases.



(Includes Integral Cable Trough)

Modesty Panel w/Trough - 10¼"H

PTLFMOD60 (For 60"W Tops) \$149.00

PTLFMOD72 (For 72"W Tops) \$162.00

Available In SI Silver, BK Matte Black

Note: For Flip Top nesting table bases (Style 2 & 3).



NEW! AE American Elm
(†Select SKUs)



CG Coastal Gray



ES Espresso

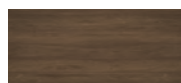

MW Modern Walnut



MH Mahogany



CH Cherry



WH White



MA Maple

Note: American Elm only available for select SKUs. Select SKUs are notated by a † mark at the end of their SKU.



OS TRAINING TABLES

Training Typical - Style 1
OST13†
 Total List: \$6,630.00
 144"W x 168"D x 29½"H
Excludes Seating & Accessories
Pictured w/Triumph Seating



Pictured w/CoolMesh Pro Seating

OST13 | Components

SKU #	QTY	DESCRIPTION	W x D x H
PLT2472†	6	Rectangular Top	72 x 24 x 1
PBF72	6	Flip Top, Nesting Base	63¼ x 20½ x 28½

Training Typical - Style 1

OST14†
 Total List: \$6,114.00
 60"W x 24"D x 29½"H
Excludes Seating & Accessories

OST14 | Components

SKU #	QTY	DESCRIPTION	W x D x H
PLT2460†	6	Rectangular Top	60 x 24 x 1
PBF60	6	Flip Top, Nesting Base	51¼ x 20½ x 28½

Training Typical - Style 1

OST03†
 Total List: \$3,612.00
 48"W x 24"D x 29½"H
Excludes Seating & Accessories

OST03 | Components

SKU #	QTY	DESCRIPTION	W x D x H
PLT2448†	4	Rectangular Top	48 x 24 x 1
PBF48	4	Flip Top, Nesting Base	37½ x 20½ x 28½



Pictured w/Franklin Seating

Note: American Elm only available for select SKUs. Select SKUs are notated by a † mark at the end of their SKU.



**NEW! Training Typical - Style 2
OSTYP326†**
Total List: \$6,540.00
60"W x 30"D x 29½"H
Excludes Seating & Accessories
Pictured w/CoolMesh Pro Seating

OS TRAINING TABLES



Pictured w/CoolMesh Pro Seating



Pictured w/NEW! Armless Oslo Guest Seating

NEW! OSTYP326 | Components

SKU #	QTY	DESCRIPTION	W x D x H
PLT3060†	5	Rectangular Top	60 x 30 x 1
PTLF60	5	Flip Top, Nesting Base	45¾ x 23 x 28½

Training Typical - Style 2 OST27†

Total List: \$13,750.00
Single Unit: 60"W x 24"D x 29½"H
Excludes Seating & Accessories

OST27 | Components

SKU #	QTY	DESCRIPTION	W x D x H
PLT2460†	10	Rectangular Top	60 x 24 x 1
PTLF60	10	Flip Top, Nesting Base	45¾ x 23 x 28½
PTLFMOD60	10	Modesty Panel	44¾ x 2¼ x 10¼

NEW! Training Typical - Style 2 OSTYP320†

Total List: \$9,184.00
216"W x 168"D x 29½"H
Excludes Seating & Accessories

NEW! OSTYP320 | Components

SKU #	QTY	DESCRIPTION	W x D x H
PLT2472†	7	Rectangular Top	72 x 24 x 1
PTLF72	7	Flip Top, Nesting Base	58 x 23 x 28½

Note: American Elm only available for select SKUs. Select SKUs are notated by a † mark at the end of their SKU.



OS TRAINING TABLES

Training Typical - Style 3
OST26†
 Total List: \$11,560.00
 48"W x 24"D x 31"H
 Excludes Accessories



Pictured w/Franklin Seating

OST26 | Components

SKU #	QTY	DESCRIPTION	W x D x H
PLT2448†	10	Rectangular Top	48 x 24 x 1
FTHAB4872	10	Flip Top, Nesting Adj. Width Base	45-68½ x 24-30 x 30

Training Typical - Style 4

OST20†
 Total List: \$11,318.00
 48"W x 30"D x 29½"H
 Excludes Seating & Accessories

OST20 | Components

SKU #	QTY	DESCRIPTION	W x D x H
PLT3060†	10	Rectangular Table Top	60 x 30 x 1
OSTLEG30	6	"T" Leg Base (Set of 2)	30 x 6 x 28½
PLTAP1530S	8	Frosted Acrylic Shield	30 x ¼ x 15
PLT60MS	5	Stiffener Support (Set of 2)	48 x 2¼ x 1
PLTSBUDMDUAL	8	Dual Mount Shield Bracket	(Set of 2)



Pictured w/Triumph Seating

NEW! Training Typical - Style 4

OSTYP312†
 Total List: \$1,922.00
 60"W x 24"D x 44½"H
 Excludes Seating & Accessories

NEW! OSTYP312 | Components

SKU #	QTY	DESCRIPTION	W x D x H
OSTLEG24	2	"T" Leg Base (Set of 2)	24 x 6 x 28½
PLT2460†	1	Rectangular Table Top	48 x 30 x 1
OSCLMBSI	2	Work Surface Clamp Bracket	
PLTFP1554	1	Fabric Shield	54 x ½ x 15
PLT60MS	1	Stiffener Support (Set of 2)	48 x 2¼ x 1

Note: **OSTYP312** is based on a single desk workstation set-up. For multiple desk units, please double the amount as needed.

Note: American Elm **only** available for select SKUs. Select SKUs are notated by a † mark at the end of their SKU.



OS TRAINING TABLES

Training Typical - Style 4
OST19†
 Total List: \$8,752.00
 48"W x 30"D x 29½"H
 Excludes Seating & Accessories
 Pictured w/Triumph Seating



Pictured w/Julep Seating

OST19 | Components

SKU #	QTY	DESCRIPTION	W x D x H
PLT3048†	8	Rectangular Table Top	48 x 30 x 1
OSTLEG30	8	"T" Leg Base (Set of 2)	30 x 6 x 28½
PLTAP1542S	4	Frosted Acrylic Shield	42 x ¼ x 15
PLTSBUDMDUAL	4	Desk Mount Shield Brackets	(Set of 2)

Training Typical - Style 5

OST08†

Total List: \$4,196.00
 60"W x 30"D x 29½"H
 Excludes Seating & Accessories

OST08 | Components

SKU #	QTY	DESCRIPTION	W x D x H
PLT3060†	4	Rectangular Top	60 x 30 x 1
PLTSQPOSTLEG	8	Offset Square Legs Base	2 x 2 x 28½
PLT60MS	2	Stiffener Support (Set of 2)	48 x 2¼ x 1

Training Typical - Style 6

OST07†

Total List: \$3,492.00
 72"W x 30"D x 29½"H
 Excludes Seating & Accessories

OST07 | Components

SKU #	QTY	DESCRIPTION	W x D x H
PLT3072†	4	Rectangular Top	72 x 30 x 1
OSPOST28G	8	Post Table Leg Base (Set of 2)	4-6" Dia x 28½
PLT72MS	2	Stiffener Support (Set of 2)	60¼ x 2¼ x 1



Pictured w/CoolMesh Seating

Note: American Elm only available for select SKUs. Select SKUs are notated by a † mark at the end of their SKU.



OS CONFERENCE TABLES "Boat Shaped Tops"

Conference Typical
PLELP236†
 Total List: \$2,418.00
 95"W x 28/44"D x 29½"H
 Excludes Seating & Power Insert
 Pictured w/Bradley Seating

Boat Shaped Conference Table w/Slab Base

(*Two Piece Tops w/Two Grommets)

PL235†	6' Table Length	72"W x 20/35"D x 29½"H	\$822.00
PL236†	8' Table Length	95"W x 28/44"D x 29½"H	\$1,456.00
PL237†*	10' Table Length	120"W x 32/47¼"D x 29½"H	\$2,309.00
PL238†*	12' Table Length	144"W x 32/47¼"D x 29½"H	\$3,151.00

Boat Shaped Conference Table w/Elliptical Base

(*Two Piece Tops w/Two Grommets)

PLELP236†	8' Table Length	95"W x 28/44"D x 29½"H	\$2,418.00
PLELP237†*	10' Table Length	120"W x 32/47¼"D x 29½"H	\$3,271.00
PLELP238†*	12' Table Length	144"W x 32/47¼"D x 29½"H	\$4,621.00

Note: Grommets standard on all conference tops. Espresso, Modern Walnut & Coastal Gray come standard with Silver Grommets. **NEW!** American Elm, Cherry, Mahogany & Maple come standard with Black Grommets.

Note: Elliptical Bases Only Available in **NEW!** American Elm, Espresso, Modern Walnut, & Coastal Gray and come standard with Silver Trim Legs.

Pictured (1) PLELP236 - 8'
Boat Shaped Table w/Elliptical Base



Mobile Lectern

PL216
 23⅝"W x 23⅝"D x 46"H
 List: \$946.00

Note: Available in CG Coastal Gray, ES Espresso & MH Mahogany Only.

OPTIONAL POWER



Open

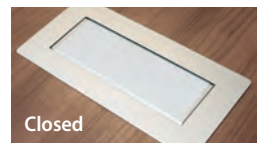

Closed

Power Insert

PLTBPOWER

Cutout: 9⅝"W x 4½"D
 Overall: 10⅝"W x 4⅞"D
 List: \$874.00

Available In SI Silver & BK Black

Note: This product can be shipped by a small package carrier. 📦

(See page 231 for details)

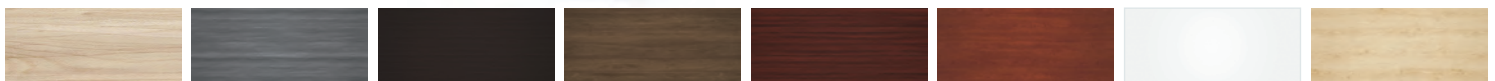

NEW! AE American Elm
(†Select SKUs)

CG Coastal Gray

ES Espresso

MW Modern Walnut

MH Mahogany
(Select SKUs)

CH Cherry
(Select SKUs)

WH White
(Select SKUs)

MA Maple
(Select SKUs)

Note: American Elm only available for select SKUs. Select SKUs are notated by a † mark at the end of their SKU.



OS CONFERENCE TABLES "Boat Shaped Expandable Tops"

Pictured w/Franklin, Integrate & Willow Seating

Boat Shaped Conference Table w/Slab Base - 47¼"D x 29½"H

(*Two Piece Tops w/Two Grommets)

PL237†*	10' Length	\$2,309.00
PL238†*	12' Length	\$3,151.00
PLCB14†	14' Length	\$3,920.00
PLCB16†	16' Length	\$4,494.00
PLCB18†	18' Length	\$5,263.00
PLCB20†	20' Length	\$5,837.00
PLCB22†	22' Length	\$6,606.00
PLCB24†	24' Length	\$7,180.00
PLCB26†	26' Length	\$7,949.00
PLCB28†	28' Length	\$8,523.00
PLCB30†	30' Length	\$9,292.00

Boat Shaped Conference Table w/Elliptical Base - 47¼"D x 29½"H

(*Two Piece Tops w/Two Grommets)

PLELP237†*	10' Length	\$3,271.00
PLELP238†*	12' Length	\$4,621.00
PLCBELP14†	14' Length	\$6,149.00
PLCBELP16†	16' Length	\$6,723.00
PLCBELP18†	18' Length	\$8,251.00
PLCBELP20†	20' Length	\$8,825.00
PLCBELP22†	22' Length	\$10,353.00
PLCBELP24†	24' Length	\$10,927.00
PLCBELP26†	26' Length	\$12,455.00
PLCBELP28†	28' Length	\$13,029.00
PLCBELP30†	30' Length	\$14,557.00

Note: Grommets standard on all conference tops. Espresso, Modern Walnut & Coastal Gray come standard with Silver Grommets. NEW! American Elm, Cherry, Mahogany & Maple come standard with Black Grommets.

Note: Elliptical Bases Only Available in NEW! American Elm, Espresso, Modern Walnut, & Coastal Gray and come standard with Silver Trim Legs.



Pictured (1) PLCB14 - 14'
Boat Shaped Table w/Slab Base

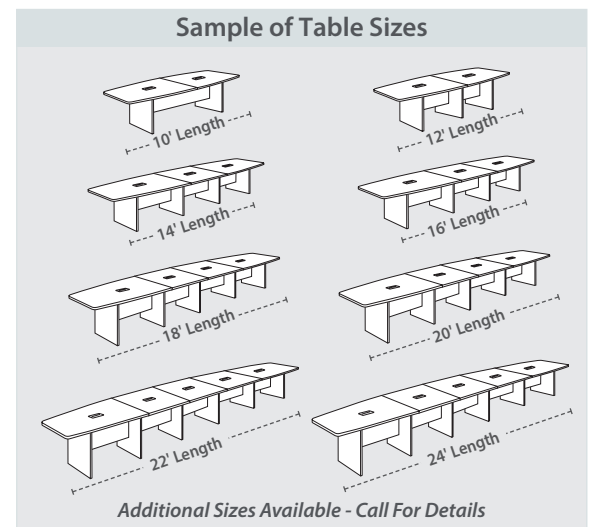

OPTIONAL POWER

Power Insert PLTBPOWER

Cutout: 9½"W x 4½"D
Overall: 10¾"W x 4⅞"D
List: \$874.00



Available In SI Silver & BK Black (See page 231 for details)

Note: This product can be shipped by a small package carrier.



NEW! AE American Elm
(†Select SKUs)

CG Coastal Gray

ES Espresso

MW Modern Walnut

MH Mahogany
(Select SKUs)

CH Cherry
(Select SKUs)

WH White
(Select SKUs)

MA Maple
(Select SKUs)

Note: American Elm **only** available for select SKUs. Select SKUs are notated by a † mark at the end of their SKU.



PALISADES

Pictured w/Palma Seating & Palisades Bookcases

A 96"W Standing Height Table (Not Pictured)
(6 Cutouts for EVT900BK)

EVST8
95¼"W x 47¼"D x 42"H
List: \$5,346.00

B 72"W Sitting Height Conference Table
(Pre-cut Grommet Insert + Cover)

EVT6
72"W x 47¼"D x 29¾"H
List: \$2,814.00



C 96"W Sitting Height Conference Table
(2 Pre-cut Grommet Inserts + Covers)

EVT8
95¼"W x 47¼"D x 29¾"H
List: \$2,943.00

D 120"W Sitting Height Conference Table
(2 Pre-cut Grommet Inserts + Covers)

EVT10
120"W x 47¼"D x 29¾"H
List: \$5,080.00



E 42"W Round Conference Table
EV42R
42"W x 42"D x 29¾"H
List: \$1,215.00

OPTIONAL POWER
Daisy Chain Power Module
(For EVST8 Only)
EVT900BK (Black Only)
List: \$660.00

Note: Daisy chained up to (3) power modules only. Power modules are sold separately as a set of (3).

GG Gauntlet Gray w/Graphite Metal

Note: **PLTBPOWER** is an optional power insert option that fits **EVT6, EVT8 & EVT10**.
This product is part of a complete collection. See Pages 20-23

ROWLAND

A 48"W Conference Table
CM2048
48"W x 48"D x 30"H
List: \$3,075.00

Multiple tables can be put together to create your desired length.



MH Mahogany



This product is part of a complete collection. See Pages 4-5



Pictured w/(2) CM2048 - ROWLAND4



**NEW! Conference Typical
OSTYP305†**
Total List: \$2,796.00
95"W x 72"D x 72"H
Includes: (1) PL236 & (2) PL156
Excludes Seating & Accessories
Pictured w/Oslo Seating

OS CONFERENCE / MULTI-PURPOSE

Design Your Own With OfficeSource®

A well designed meeting room can facilitate great discussions, idea generation, productive meetings, and even just a place to relax. The perfect conference table can help create a professional environment when interacting with clients or customers. The perfect multi-purpose table can create an atmosphere for collaboration and to enjoy a break or a meal.

TABLE LEG BASE OPTIONS

Several different table bases to choose from with varying finish options.

1. Flat "T" Metal Leg Base - (Silver & Matte Black)
2. Cube Laminate Base - (8 Finishes - Select SKUs)
3. "X" Laminate Base - (6 Finishes - Select SKUs)
4. Oblique Style Wood Base - (Modern Walnut & Coastal Gray)
5. Oblique Style Metal Base - (Silver & Matte Black)
6. 41" Oblique Style Metal Base - (Silver & Matte Black)
7. Unite Style Base - 28½" - (Silver & Matte Black)
8. Unite Style Base - 41" - (Silver Only)
9. Beveled Leg Base - (Silver & Matte Black)
10. Board Style Base - (Brushed Aluminum & Matte Black)
11. Tri-Leg Base - (Silver Only)
12. Cross Base - (Matte Silver & Matte Black)
13. 4 Prong Base - (Brushed Aluminum)
14. Round Base - (Brushed Aluminum & Matte Black)
15. Square Base - (Brushed Aluminum)
16. Slab End Panel Laminate Base - (8 Finishes)
17. 18" Or 28" Hairpin Leg Base - (Silver & Matte Black)

SEVERAL TOP SHAPES & SIZES

Choose from Rectangular, Boat Shaped, Half Boat Shaped, Round, Square & Clear Glass



Pictured w/NEW! American Elm Finish

Configure Your Way!

OS CONFERENCE/MULTI-PURPOSE TABLES

Custom Build Your Training Or Multi-Purpose Table By Combining Table Tops & Bases

Pictured w/PL235T Top



Slab Style Bases
PL35EMODSB (1)

Available in 8 Finishes
Shown in NEW! American Elm

Pictured w/PLT Top



41" Oblique Style Bases
PLTVAMETLEG41A1 (2) &
PLTVALEGM243041CB (2)

Available in Matte Black or Silver Metal

Note: 41" Oblique Legs Require Beams. (See Page 119)



Cube Bases Provide
Easy Access To Cords

Cube Style Bases
PLCUBED20 (2)

Available in Standard Height 28"H
or Café Height 41"H



Board Style Bases
PLTBTB32 (2)

Available in Matte Black or Brushed Aluminum



Oblique Style Bases
PLTVAWLEG (3) & PLTVALEGM3642 (3)

Available in Wood or Metal Finishes

Note: Oblique Legs Require Beams. (See Page 119)



Note: Oblique Legs & Unite
Inset Legs Require Beams.
(See Page 119)

Oblique Style Bases w/Unite Inset Base
PLTVAMETLEG (2), PLTVALEGM3642 (2)
& PLTULEG4860ILCMB (2)

Can be combined with Unite Inset Legs



AE American Elm
NEW! (†Select SKUs)

CG Coastal Gray

ES Espresso

MW Modern Walnut



MH Mahogany



CH Cherry

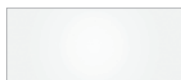

WH White
(Select SKUs)



MA Maple
(Select SKUs)

Note: American Elm only available for select SKUs. Select SKUs are notated by a † mark at the end of their SKU.

Some items in this collection come ready-to-assemble.

Round Multi-Purpose Top



X Style Base
PLWXB3642

Available in
Standard or Café Height

Square Conference Top
(Pictured w/PL139T Top)



Cube Style Base
PLCUBED2040

Available in
Standard or Café Height



OS CONFERENCE/MULTI-PURPOSE TABLES

Pictured w/NEW! Jola Seating & NEW! OSTYP331 Typical

OfficeSource® Tables are put to use in many different ways.

Great Options for Both Style and Versatility.

Breakroom • Classroom • Office • Training • Lobby

RECTANGULAR GLASS TOP

Rectangular "Tempered" Black Glass Top (Thickness 12MM)

PGT2460 Rectangular Glass Top 60"W x 24"D x 1/2"H \$1,050.00

Rectangular Glass Top only works well with 24"D Beveled Leg Bases & Unite Leg Bases.

Note: Beveled & Unite leg bases require beams & brackets. (See Page 119)



Glass Top
w/Beveled Base
PGT2460BK x1
PLTLEGBV24SI x2
PLTCBBEV x2
PLTADJMDB4872 x1



BK Black



Laminate Conference Tops
Include PVC Tough Edge
Ensures Long-Lasting Durability

CONFERENCE TOPS

Boat Shaped Conference Tops

PL235T†	6' Boat Shape Top	71"W x 36"D x 1 1/2"H	\$487.00
PL236T†	8' Boat Shape Top	95"W x 44"D x 1 1/2"H	\$805.00
PL237THALF+*	5' Boat Shape Top	60"W x 47 1/4"D x 1 1/2"H	\$776.00
PL238THALF+*	6' Boat Shape Top	71"W x 47 1/4"D x 1 1/2"H	\$1,063.00

*Note: Two half tops needed to make a 10' or 12' table.

Square & Rectangular Conference Tops

PL139T†	4' Square Top	47 1/4"W x 47 1/4"D x 1 1/2"H	\$791.00
PL437THALF+*	Half Rectangular Top	60"W x 47"D x 1 1/2"H	\$735.00
PL438THALF+*	Half Rectangular Top	71"W x 47"D x 1 1/2"H	\$1,031.00

Note: Grommets standard on all conference tops, including half tops.



AE American Elm
NEW! (†Select SKUs)

CG Coastal Gray

ES Espresso

MW Modern Walnut

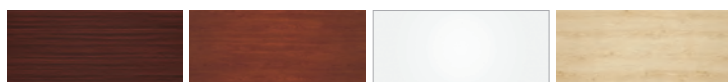

MH Mahogany

CH Cherry

WH White

MA Maple

MULTI-PURPOSE TOPS

Rectangular Tops

PLT2460†	Rectangular Top	60"W x 24"D x 1"H	\$405.00
PLT2466†	Rectangular Top	66"W x 24"D x 1"H	\$443.00
PLT2472†	Rectangular Top	72"W x 24"D x 1"H	\$443.00
PLT3060†	Rectangular Top	60"W x 30"D x 1"H	\$487.00
PLT3066†	Rectangular Top	66"W x 30"D x 1"H	\$519.00
PLT3072†	Rectangular Top	72"W x 30"D x 1"H	\$519.00

Round & Square Tops

PLT30R	30" Round Top	30" Dia x 1"H	\$282.00
PLT36R†	36" Round Top	36" Dia x 1"H	\$315.00
PLT42R†	42" Round Top	42" Dia x 1"H	\$360.00
PLT48R†	48" Round Top	48" Dia x 1"H	\$443.00
PGT24RCLEAR	24" Round Glass	24" Dia x 1/2"H	\$543.00
PGT36RCLEAR	36" Round Glass	36" Dia x 1/2"H	\$708.00
PLT30S	30" Square Top	30"W x 30"D x 1"H	\$282.00
PLT36S†	36" Square Top	36"W x 36"D x 1"H	\$315.00
PLT42S	42" Square Top	42"W x 42"D x 1"H	\$360.00
PLT48S	48" Square Top	48"W x 48"D x 1"H	\$443.00

Note: Round glass tops compatible with PLTRB2319, PLTSQ2319, PLTHDXB2319 & PLTHDXB3019 bases only. Multi-purpose tops do not come with grommets.

Note: American Elm only available for select SKUs. Select SKUs are notated by a † mark at the end of their SKU.

OS CONFERENCE/MULTI-PURPOSE TABLES



*Note: Certain Bases Require Beams & Brackets. See Page 119 for more details.

Note: Hairpin Legs & Flat Metal "T" Leg bases can be shipped by a small package carrier. 📦

A Cube Laminated Table Base - 28½" & 41"H

PLCUBED20† 19½"W x 19½"D x 28½"H \$635.00
 PLCUBDED2040 19½"W x 19½"D x 41"H \$709.00

Note: Café Height Base can be used with rectangular tops, but require two bases. Table base heights do not include top, add top thickness of 1" for complete table height. **Two bases are required** for PLCUBED20 & PLCUBED2040 to be used with 6' conference table tops.

PLCUBED2040 available in CG Coastal Gray, ES Espresso, MW Modern Walnut & WH White only

B Slab End Panel Laminated Base - 28"H

PL35EMODSB† 38¼"W x 23⅝"D x 28½"H \$335.00

Note: Slab End Panel Base used with PL235T only. Available in CH Cherry, MH Mahogany, ES Espresso, MA Maple, MW Modern Walnut, CG Coastal Gray, WH White & NEW! AE American Elm

C Oblique Legs - 28½"H

PLTVAMETLEG* (Metal Legs) \$140.00
 PLTVAWLEG* (Wood Legs) \$154.00

Available in SI Silver, BK Matte Black, MW Modern Walnut & CG Coastal Gray

Note: Oblique Legs require PLTVALEGM leg mounts.

D Oblique Legs - 41"H

PLTVAMETLEG41A1* (Metal Legs) \$191.00

Note: 41" Metal Oblique Legs require Support Leg Kit. Legs require at least (2) Adjustable Beams when used. Support Leg Kit contains cross beam & leg mount.

Available in SI Silver & BK Matte Black

E Unite Leg Bases - 41"H

PLTULEG2441A1* (For 24"D Tops) \$375.00
 PLTULEG3041* (For 30"D Tops) \$384.00
 PLTULEG3641* (For 36"D Tops) \$506.00

Available in SI Silver Only

Unite Leg Bases - 28½"H

PLTULEG24* (For 24"D Tops) \$326.00
 PLTULEG30* (For 30"D Tops) \$341.00
 PLTULEG36* (For 36"D Tops) \$464.00
 PLTULEG48* (For (2) 24"D Tops) \$492.00
 PLTULEG60* (For (2) 30"D Tops) \$522.00

Available in SI Silver & BK Matte Black

F Beveled Leg Base

PLTLEGBV24* (For 24"D Tops) \$448.00
 PLTLEGBV30* (For 30"D Tops) \$501.00
 PLTLEGBV36* (For 36"D Tops) \$626.00
 PLTLEGBV48* (For (2) 24"D Tops) \$750.00
 PLTLEGBV60* (For (2) 30"D Tops) \$827.00

Available in SI Silver & BK Matte Black

G Board Table Base

PLTBTB32 1"W x 5"D x 28½"H \$937.00

Available in BA Brushed Aluminum & BK Matte Black

H Tri-Leg - Single Leg

PLTVLEG128* 32"W x 16"D x 28½"H \$136.00

Available in SI Silver Only

Laminate Base Finishes

I Hairpin Leg (Set of 4)

HP18LEG 18"H \$352.00
 HP28LEG 28"H \$448.00

Available in SI Silver & BK Matte Black

J Inset Leg - 28½"H

PLTULEG4860ILCMB* \$737.00

(Includes Removable Wire Management Cover & PLTMBMBC Brackets)
 Available in SI Silver Only

K Flat Metal "T" Leg Base

(For 24"D & 30"D Tops)
 OSFTLEG24 \$528.00 ctn.
 23⅝"W x 6"D x 28½"H
 OSFTLEG30 \$658.00 ctn.
 28"W x 6"D x 28½"H

Note: Flat Metal "T" Leg Base Priced (2) Per Carton. Tops 60" or larger require the purchase of stiffener bars.

Available in SI Silver & BK Matte Black



AE American Elm
 NEW! (†Select SKUs)

CG Coastal Gray

ES Espresso

MW Modern Walnut

MH Mahogany
 (Select SKUs)

CH Cherry
 (Select SKUs)

WH White

MA Maple
 (Select SKUs)

Metal Leg Base Finishes

Oblique Wood Leg Base Only Finishes

BK Black

SI Silver

CG Coastal Gray

MW Modern Walnut

Note: American Elm **only** available for select SKUs. Select SKUs are notated by a † mark at the end of their SKU.

OS CONFERENCE/MULTI-PURPOSE TABLES



Pictured w/PL438 Conference Table & Veneto Seating - Page 197



Pictured w/PL437 Conference Table & Boxero Seating - Page 204



Pictured w/PL437 Conference Table & Oslo Seating - Page 177



Pictured w/PL437 Conference Table & Merak Seating - Page 201

Table Hardware - Beams & Supports for Oblique, Beveled & Unite Leg Bases



Adjustable Beam
PLTADJMDB4872*
 (Extends For Desks 48-72"W)
 List: \$181.00 ea.

PLTADJMDB7896*
 (Extends For Returns 78-96"W
 & 48" Bridge Tops)
 List: \$224.00 ea.

Beam Cover
 (Cover To Conceal Adj. Beam
 & Hardware For 72"W Tops Only)
PLTMDB72C* (Not Pictured)
 List: \$154.00 ea.



Return Bracket
PLTRBB* (For Adjustable Beams)
 List: \$64.00 ea.
 Note: Includes (2) PLTFB.



Includes (2)
 Flat Plates

Return Support
PLTRETSUPPORTSI (Silver Only)
 10 1/8"W x 7"D x 2 1/8"H
 List: \$87.00 ea.



Connector Beam Bracket
PLTCBBEVS1 (Silver Only)
 (Required For Beveled Leg Base)
 List: \$83.00 ea.

Note: 1 or 2 Required
 Depending On Usage.



Connector Beam Bracket
PLTMBMBCSI (Pair - Silver Only)
 (For Oblique & Inset Legs)
 List: \$70.00 ea.



Connector Beam Bracket
PLTCBBSINGLE*
 (For Unite Leg Base)
 List: \$56.00 ea.

Note: 1 or 2 Required
 Depending On Usage.

Support Leg Kit
 (For 41"H Oblique Legs Only)
PLTVALEGM243041CB*
 (For 24-30"D Tops)
 List: \$245.00 ea.
PLTVALEGM364241CB*
 (For 36-42"D Tops)
 List: \$332.00 ea.
PLTVALEGM486041CB*
 (For 48-60"D Tops)
 List: \$451.00 ea.



Oblique Leg Mounts
PLTVALEGM2430*
 (For 24-30"D Tops)
 List: \$140.00 ea.

PLTVALEGM3642*
 (For 36-42"D Tops)
 List: \$169.00 ea.

PLTVALEGM4860*
 (For 48-60"D Tops)
 List: \$253.00 ea.

Note: Required for
 both Metal & Wood
 Oblique Legs.

Hardware Finishes



BK Black
 (*Select SKUs)

SI Silver

OS CONFERENCE/MULTI-PURPOSE TABLES

Standard Height Bases All metal bases available in Standard or Café height; Round, Square & 4 Prong also available in occasional height.



CROSS BASES

PLTXBM24	Standard Base - Black (Fits up to 36" Tops)	\$326.00
PLTXBM24	Standard Base - Silver (Fits up to 36" Tops)	\$326.00
PLTXBM33	Standard Base - Black (Fits up to 48" Tops)	\$357.00
PLTXBM33	Standard Base - Silver (Fits up to 48" Tops)	\$357.00
PLTXBM3341	Café Height Base - Black (Fits up to 36" Tops)	\$448.00
PLTXBM3341	Café Height Base - Silver (Fits up to 36" Tops)	\$448.00

Available In SI Matte Silver & BK Matte Black

ROUND & SQUARE BASES

PLTRB2319	Occasional Height Round Base (Fits up to 36" Tops)	\$684.00
PLTRB2328	Standard Round Base (Fits up to 42" Tops)	\$704.00
PLTRB2341	Café Height Round Base (Fits up to 30" Tops)	\$752.00
PLTSQ2319	Occasional Height Square Base (Fits up to 36" Tops)	\$742.00
PLTSQ2328	Standard Square Base (Fits up to 42" Tops)	\$744.00
PLTSQ2341	Café Height Square Base (Fits up to 30" Tops)	\$823.00

Round Bases Available In BA Brushed Aluminum & BK Matte Black

Square Bases Available in BA Brushed Aluminum Only

4 PRONG BASES

PLTHDXB2319	Occasional Height Base (Fits up to 36" Tops)	\$739.00
PLTHDXB2328	Standard Base (Fits up to 36" Tops)	\$771.00
PLTHDXB2341	Café Height Base (Fits up to 30" Tops)	\$880.00
PLTHDXB3019	Occasional Height Base (Fits up to 48" Tops)	\$925.00
PLTHDXB3028	Standard Base (Fits up to 48" Tops)	\$957.00
PLTHDXB3041	Café Height Base (Fits up to 36" Tops)	\$1,066.00

Note: Café Height Base Can Be Used With Rectangular Tops, But Require Two Bases.

Available In BA Brushed Aluminum

X TABLE BASES

PLWXB3642†	X Base (For 36" & 42" Tops)	\$285.00
PLWXB48	X Base (For 48" Top)	\$357.00

Available In CH Cherry, MH Mahogany, ES Espresso, MW Modern Walnut, CG Coastal Gray & NEW! AE American Elm (PLWXB3642 Only).

Note: American Elm only available for select SKUs. Select SKUs are notated by a † mark at the end of their SKU.

Note: PLTRB2328 & PLTRB2341 table bases can be shipped by a small package carrier. 📦

OS CONFERENCE/MULTI-PURPOSE TABLES

Base Styles (17 Base Options)

Work Surfaces (Variety of Shapes & Sizes, 8 Finishes)



Oblique Leg Base

Pictured w/Tre Lite Seating & NEW! OSTYP313 Typical



Unite Leg Base

Pictured w/Willow & Tribeca Seating & NEW! OSTYP330 Typical



Standard Square Table Base

Pictured w/Slash Seating OSC16 Typical



OS CONFERENCE/MULTI-PURPOSE TABLES

**NEW! Multi-Purpose Typical
OSTYP331†**
Total List: \$14,511.00
72"W x 24"D x 42"H
Excludes Seating & Accessories
Pictured w/NEW! Jola Seating



Pictured w/CoolMesh Seating

NEW! OSTYP331 | Components

SKU #	QTY	DESCRIPTION	W x D x H
PLT2472†	5	Rectangular Top	72 x 24 x 1
PLT36R†	4	36" Round Top	36 x 42 x 1
PLT72MSBK	5	Stiffener Support (Set of 2)	60¼ x 2¼ x 1
PLTRB2328	4	Standard Round Base	22¾ x 22¾ x 19
PLTRB2341	10	Café Height Round Base	22¾ x 22¾ x 41

Conference Typical OSC25†

Total List: \$822.00
71"W x 36"D x 29½"H
Excludes Seating & Accessories

OSC25 | Components

SKU #	QTY	DESCRIPTION	W x D x H
PL235T†	1	6' Boat Shaped Top	71 x 36 x 1½
PL35EMODSB†	1	Slab Laminate Base	38¼ x 23¾ x 28½

Multi-Purpose Typical OSC12†

Total List: \$3,698.00
72"W x 36"D x 29½"H
Excludes Seating & Accessories

OSC12 | Components

SKU #	QTY	DESCRIPTION	W x D x H
PLT3672†	2	Rectangular Top	72 x 36 x 1½
PLTULEG36	4	Unite Leg Base (For 36"D Tops)	28½"H
PLTADJMDB4872	2	Adjustable Beam	67¾ x 2 x 1
PLTCBBSINGLE	4	Connector Beam Bracket	



Pictured w/Perch Seating

Note: American Elm only available for select SKUs. Select SKUs are notated by a † mark at the end of their SKU.



OS CONFERENCE/MULTI-PURPOSE TABLES

**Conference Typical
OSC18†**
Total List: \$2,679.00
95"W x 44"D x 29½"H
Excludes Seating & Accessories
Pictured w/Cade Seating



OSC18 | Components

SKU #	QTY	DESCRIPTION	W x D x H
PLTBTB32	2	Board Table Base	32 x 16 x 28½
PL236†	1	Boat Shaped Conference Top	95 x 44 x 1½

Conference Typical OSC30†

Total List: \$2,046.00
132"W x 30"D x 29"H
Excludes Accessories

*Note: Only (6) out of the (8) HP28LEG are needed to be used in this typical. You will have (2) extra left.

OSC30 | Components

SKU #	QTY	DESCRIPTION	W x D x H
PLT3066†	2	Rectangular Top	66 x 30 x 1
HP28LEG	2	Hairpin Legs (Set of 4)	6 x 6 x 28"H
PLT60MS	1	Stiffener Support (Set of 2)	48 x 2¼ x 1



Pictured w/Parson Seating

Conference Typical OSC31†

Total List: \$5,379.00
189"W x 47¼"D x 29½"H
Excludes Seating & Accessories

OSC31 | Components

SKU #	QTY	DESCRIPTION	W x D x H
PLTVAMETLEG	4	Oblique Metal Legs	1 x 3 x 29¾
PLTVALEGM3642	4	Oblique Leg Mounts	
PLTMBMBC	2	Connector Beam Bracket (Set of 2)	
PL238THALF†	2	6' Boat Shape Top	71 x 47¼ x 1½
PL139†	1	4' Square Top Section	47¼ x 47¼ x 1½
PLTADJMDB4872	6	Adjustable Beam	67½ x 2 x 1

Note: American Elm only available for select SKUs. Select SKUs are notated by a † mark at the end of their SKU.



OS CONFERENCE/MULTI-PURPOSE TABLES

**Conference Typical
OSC04†**
Total List: \$6,248.00
236¼"W x 47¼"D x 29½"H
Excludes Seating & Accessories
Pictured w/Cade Seating



Pictured w/CoolMesh Seating

OSC04 | Components

SKU #	QTY	DESCRIPTION	W x D x H
PL238THALF†	2	6' Boat Shape Top	71 x 47¼ x 1½
PLCUBED20†	4	Cube Table Base w/Access Door	19½ x 19½ x 28
PL139T†	2	4' Square Top Section	47¼ x 47¼ x 1½

**Conference Typical
OSC27†**
Total List: \$1,426.00
47"W x 47"D x 30"H
Excludes Seating & Accessories

OSC27 | Components

SKU #	QTY	DESCRIPTION	W x D x H
PL139T†	1	4' Square Top Section	47¼ x 47¼ x 1½
PLCUBED20†	1	Cube Table Base w/Access Door	19½ x 19½ x 28



Pictured w/Stacked Seating & Rise Seating

**NEW! Multi-Purpose Typical
OSTYP314†**
Total List: \$9,456.00
216"W x 41"H
Individual Table - Occasional: 36"W x 42"D x 19"H
Individual Table - Café: 36"W x 42"D x 41"H
Excludes Seating & Accessories

NEW! OSTYP314 | Components

SKU #	QTY	DESCRIPTION	W x D x H
PLT36R†	3	36" Round Top	36 x 42 x 1
PLT3060†	3	Rectangular Top	60 x 30 x 1½
PLTRB2328	3	Standard Round Base	22¾ x 22¾ x 19
PLTSQ2341	6	Café Height Square Base	22¾ x 22¾ x 41

Note: American Elm only available for select SKUs. Select SKUs are notated by a † mark at the end of their SKU.



OS CONFERENCE/MULTI-PURPOSE TABLES

**NEW! Multi-Purpose Typical
OSTYP315†**

Total List: \$8,532.00
144"W x 41"H
Excludes Seating & Accessories
Pictured w/Willow Seating



Pictured w/Tre Lite Seating

Note: American Elm only available for select SKUs. Select SKUs are notated by a † mark at the end of their SKU.

NEW! OSTYP315 | Components

SKU #	QTY	DESCRIPTION	W x D x H
PLT3060†	4	Rectangular Top	60 x 30 x 1½
PLTSQ2341	8	Café Height Square Base	22¾ x 22¾ x 41

**NEW! Conference Typical
OSTYP313†**

Total List: \$8,123.00
142"W x 29½"H
Excludes Seating & Accessories

NEW! OSTYP313 | Components

SKU #	QTY	DESCRIPTION	W x D x H
PL237THALF†	2	5' Boat Shape Top	60 x 47¼ x 1½
PLTVALEGM3642	3	Oblique Leg Mounts	
PLTVAMETLEG	3	Oblique Metal Leg Base (Set of 2)	1 x 3 x 28½
PLTMBMBC	1	Connector Beam Bracket (Pair)	
PLTADJMDB4872	4	Adjustable Beam	67⅞ x 2 x 1
PL152†	4	Storage Cabinet	35½ x 22 x 37¼
PL110†	2	File/Storage Top	71 x 22 x 1



Pictured w/Willow Seating & Tribeca Seating

OSTYP330 is not available in AE American Elm.

**NEW! Multi-Purpose Typical
OSTYP330**

Total List: \$16,893.00
216"W x 96"D x 42"H
Excludes Seating & Accessories

NEW! OSTYP330 | Components

SKU #	QTY	DESCRIPTION	W x D x H
PLTULEG60	2	Unite Leg Base (For (2) 30"D Tops)	60 x 1½ x 28½
PLTULEG4860ILCMB	2	Inset Leg Base	35 x 5 x 28½
PLTCBBSINGLE	22	Connector Beam Bracket	
PLTADJMDB4872	15	Adjustable Beam	67⅞ x 2 x 1
PLT3072†	6	Rectangular Top	72 x 30 x 1
PLTRB2319	2	Occasional Round Base	22⅞ x 22⅞ x 19
PLT30S	2	30" Square Top	30 x 42 x 1
PLTMDB72C	3	Beam Cover	67⅞ x 1¼ x 23⅞
PLT3672†	3	Rectangular Top	72 x 36 x 1
PLTULEG3641	6	Unite Leg Base (For 36"D Tops)	36 x 1½ x 41

OS CONFERENCE/MULTI-PURPOSE TABLES



Pictured w/Slash Seating

Multi-Purpose Typical OSC16†

Total List: \$12,042.00

72"W x 30"D x 29½"H

Excludes Seating & Accessories

OSC16 | Components

SKU #	QTY	DESCRIPTION	W x D x H
PLT3072†	6	Rectangular Top	72 x 30 x 1
PLTSQ2328	12	Standard Square Base	22¾ x 22¾ x 28½



Pictured w/Stacked Seating & Rise Seating

Multi-Purpose Typical OSC33†

Total List: \$2,808.00

Individual Table - Regular: 36"W x 42"D x 28½"H

Individual Table - Café: 36"W x 42"D x 41"H

Excludes Seating & Accessories

OSC33 | Components

SKU #	QTY	DESCRIPTION	W x D x H
PLT36R†	4	36" Round Top	36 x 42 x 1
PLTXBM3341	2	Café Height Cross Base	33 x 33 x 41
PLTXBM24	2	Cross Base	24 x 24 x 28½



Pictured w/Zella & Integrate Seating

Multi-Purpose Typical OSC29

Total List: \$8,325.00

36"W x 36"D x 29½"H

Excludes Seating & Accessories

OSC29 | Components

SKU #	QTY	DESCRIPTION	W x D x H
PLTHDXB3028	5	Standard 4 Prong Base	29¾ x 11¾ x 28
PGT36RCLEAR	5	36" Round Glass Top	36 x 36 x 1

Note: American Elm **only** available for select SKUs. Select SKUs are notated by a † mark at the end of their SKU.



NEW! SOFIA

Pictured w/NEW! Jola, NEW! Matching Ottoman & Partridge Seating
Shown w/Optional PLT3060 & PLT3072 tops in NEW! American Elm Finish

**A 60"W Conference Table
OSXC2007**
(Adjustable Foot Levelers Included)
60"W x 30"D x 30¹⁵/₁₆"H
List: \$925.00

**B 60"W Low Mobile
Collaboration Table
OSXC2008**
(Locking Nylon Casters Included)
60"W x 30"D x 22¹/₁₆"H
List: \$850.00

**C 72"W Low Mobile
Collaboration Table
OSXC2009**
(Locking Nylon Casters Included)
72"W x 30"D x 22¹/₁₆"H
List: \$925.00

**D 42"H Standing Height
Collaboration Table
OSXC2010**
(Adjustable Foot Levelers Included)
72"W x 35⁷/₁₆"D x 42"H
List: \$1,050.00

**E Mobile Ottoman
OSRL3003**
Overall: 20"W x 20"D x 17³/₄"H
List: \$385.00
Available in CR Charcoal Only

FEATURES

- Contemporary design with 1.8" thick tops and sides
- Full-length center support provides strength and durability
- Constructed with durable, melamine laminate
- Some assembly required

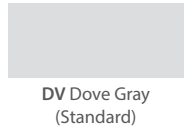

Shown w/Standard Dove Gray Finish

Give a **Dramatic Look** to Your Space!
Add an OS Laminate Top to any Sofia table
- tops are available in any finish option below



PLT3060 - Rectangular Top
60"W x 30"D
(Compatible w/OSXC2007
& OSXC2008)



PLT3072 - Rectangular Top
72"W x 30"D
(Compatible w/OSXC2009 Only)



PLT3672 - Rectangular Top
72"W x 36"D
(Compatible w/OSXC2010 Only)

Optional Laminate Top Finishes



NEW! AE
American Elm



CG Coastal Gray



ES Espresso

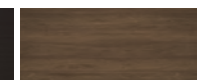

MW Modern Walnut



MH Mahogany



CH Cherry

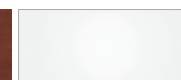

WH White



MA Maple



Shown w/NEW! American Elm Laminate Top Finish



OS PEDESTAL TABLES

Pictured w/Dover Seating



Requires Base

Laminate Table - Top
PL9997†
 29"W x 29"D x 12½"H
 List: \$501.00

Note: Must choose one of the three base options: Metal, Caster or Angled Base.



A

A Metal Pedestal - Table Base
PL9998
 29"W x 29"D x 18¼"H
 List: \$290.00



B

B Caster Pedestal - Table Base
PLPECASTERS
 List: \$67.00



C

C Angled Wood Mini Legs - Table Base
PLTAWRLEG (Set of 4)
 List: \$120.00

Available In **NO** Natural Oak, **MW** Modern Walnut & **CG** Coastal Gray



AE American Elm
 NEW! (†Select SKUs)



CG Coastal Gray



ES Espresso

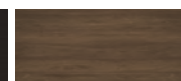

MW Modern Walnut



MH Mahogany



CH Cherry

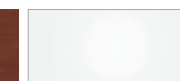

WH White



MA Maple

Note: Casters & Mini Wood Legs can be shipped by a small package carrier.

Some items in this collection come ready-to-assemble.

C-TABLE



Laminate Side C-Table
w/Silver Base
PLTC66T†
 22¼"W x 15¾"D x 25½"H
 List: \$375.00



Pictured w/Manhattan Seating & OS Pedestal Table



AE American Elm
 NEW! (†Select SKUs)



CG Coastal Gray



ES Espresso

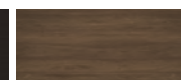

MW Modern Walnut



MH Mahogany



CH Cherry

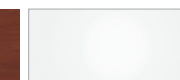

WH White



MA Maple

Note: American Elm only available for select SKUs. Select SKUs are notated by a † mark at the end of their SKU.



OS RECEPTION TABLES

Pictured w/Round Clear Glass Top w/Round Base & Madison Seating

LAMINATE & GLASS TABLE TOPS

Round & Square Tops

PLT30R	30" Round Top	30" Dia x 1"H	\$282.00
PLT36R†	36" Round Top	36" Dia x 1"H	\$315.00
PGT24RCLEAR	24" Round Glass	24" Dia x ½"H	\$543.00
PGT36RCLEAR	36" Round Glass	36" Dia x ½"H	\$708.00
PLT30S	30" Square Top	30"W x 30"D x 1"H	\$282.00
PLT36S†	36" Square Top	36"W x 36"D x 1"H	\$315.00

Note: Round glass tops come with metal center adapter.

*Note: Round glass tops compatible with **PLTRB2319**, **PLTSQ2319**, **PLTHDXB2319** & **PLTHDXB3019** bases only.*

*Laminate Finishes are **CH** Cherry, **MH** Mahogany, **ES** Espresso, **MA** Maple, **MW** Modern Walnut, **CG** Coastal Gray, **WH** White & **NEW!** **AE** American Elm*

ROUND & SQUARE BASES

PLTRB2319	Occasional Height Round Base (Fits up to 36" Tops)	\$684.00
PLTSQ2319	Occasional Height Square Base (Fits up to 36" Tops)	\$742.00

*Round Bases Available In **BA** Brushed Aluminum & **BK** Matte Black
Square Bases Available in **BA** Brushed Aluminum Only*

4 PRONG BASES

PLTHDXB2319	Occasional Height Base (Fits up to 36" Tops)	\$739.00
PLTHDXB3019	Occasional Height Base (Fits up to 48" Tops)	\$925.00

Note: Café Height Base Can Be Used With Rectangular Tops, But Require Two Bases.

*Available In **BA** Brushed Aluminum*

*Note: American Elm **only** available for select SKUs. Select SKUs are notated by a † mark at the end of their SKU.*



Pictured w/Sterling Seating

A 18"H Hairpin Leg Base (Set of 4) (For Laminate Tops Only)

HP18LEG

List: \$352.00 ctn.

*Note: Hairpin Leg Bases Priced (4)
Per Carton. Hardware Included.*

*Available In **SI** Silver & **BK** Matte Black*

*HP18LEG is not fully compatible
with 36" table tops.
Additional wood screws would
be needed.*



PALISADES

Pictured w/Partridge Seating

A Coffee Table
EVS550
 47¼"W x 23⅝"D x 17"H
 List: \$1,148.00

B End Table
EVS500
 20½"W x 20½"D x 26"H
 List: \$826.00



GG Gauntlet Gray
w/Graphite Metal

This product is part of a complete collection.
See Page 20-23



PARALLEL

A Coffee Table
PL219
 47¼"W x 23¾"D x 16"H
 List: \$628.00

B End Table
PL220†
 23¾"W x 23¾"D x 20"H
 List: \$443.00



AE American Elm
NEW! (†Select SKUs)

CG Coastal Gray

ES Espresso



MW Modern Walnut

MH Mahogany

CH Cherry

*Note: American Elm **only** available for select SKUs. Select SKUs are notated by a † mark at the end of their SKU.*



Pictured w/Tribeca Seating

ROBUST



INDOOR TABLE BASES

Standard Height - 29"H or Café Height - 41"H

QS2113030BW	Table Height - X	\$469.00
QS2113042BW	Café Height - X	\$511.00
QS2142230BW	Table Height - Round	\$555.00
QS2142242BW	Café Height - Round	\$597.00

Note: Both X and Round bases support up to 50" table tops.

OUTDOOR TABLE BASES

Standard Height - 29"H or Café Height - 41"H

QSOD2113030BW	Table Height - X	\$781.00
QSOD2113042BW	Café Height - X	\$839.00
QSOD2142230BW	Table Height - Round	\$993.00
QSOD2142242BW	Café Height - Round	\$1,050.00

Note: Both X and Round bases support up to 50" table tops.

CAFÉ HEIGHT X BASE

Indoor/Outdoor Café Height X Table Base w/Footing

QSOD2162042BW	24"W x 24"D x 42"H	List: \$1,012.00
----------------------	--------------------	------------------

INDOOR/OUTDOOR TABLE TOPS

Square - 30" & 36" Wide, Rectangular - 48" Wide; Circle 30" & 36" Diameter

QSOD30SQ	30"W x 30"D x 2"H (Square)	\$648.00
QSOD36SQ	36"W x 36"D x 2"H (Square)	\$731.00
QSOD3048	48"W x 30"D x 2"H (Rectangular)	\$827.00
QSOD30R	30"D x 2"H (Round)	\$593.00
QSOD36R	36"D x 2"H (Round)	\$690.00

INDOOR/OUTDOOR CHAIRS

A 30" Outdoor Backless Bar Stool

QSOD40530

Overall: 17¼"W x 17¼"D x 30"H
Seat: 14"W x 14"D x 30"H
List: \$839.00

B 30" Outdoor Bar Stool

QSOD40030

Overall: 16"W x 18"D x 44"H
Seat: 16¼"W x 16¼"D x 30"H
List: \$991.00

C 18" Outdoor Chair

QSOD40018

Overall: 16"W x 18"D x 32"H
Seat: 16¼"W x 16¼"D x 18"H
List: \$856.00

Note: All items on this page can be shipped by a small package carrier.

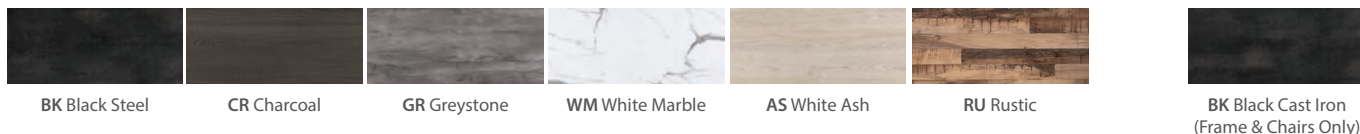

QS = QUICKSHIP Most items in this collection come fully assembled.



BLOW MOLDED FOLDING TABLES

Pictured w/Matching Blow Molded Folding Chairs - See Page 155

A Plastic Blow Molded Folding Tables (Rectangular)

FBM3060	60"W x 30"D x 29"H	30 lbs.	\$314.00
FBM3072	72"W x 30"D x 29"H	36 lbs.	\$362.00
FBM3096	96"W x 30"D x 29"H	49 lbs.	\$529.00

B Plastic Blow Molded Folding Tables (Round)

FBM60R	60"Dia x 29"H	49 lbs.	\$609.00
FBM71R	71"Dia x 29"H	75 lbs.	\$906.00

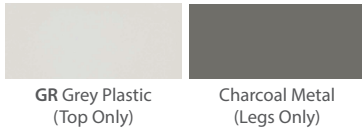

TABLE CARTS



Rectangular Table Cart
FTD3502
76"W x 31"D x 45¼"H
Weight: 74 lbs.
List: \$928.00
Available in GR Gray Only



Round Table Cart
RA106A
52"W x 32¾"D x 40½"H
Weight: 84 lbs.
List: \$943.00
Available in GR Gray Only

COLORFUL BLOW MOLDED FOLDING TABLES

A R-Series Blow Molded Folding Tables (Fixed Height)

QSR2448	48"W x 24"D x 29"H	\$698.00
QSR3060	60"W x 30"D x 29"H	\$869.00
QSR3072	72"W x 30"D x 29"H	\$925.00

B RA-Series Blow Molded Folding Tables (Adjustable Height)

QSRA2448	48"W x 24"D x 22-32"H	\$904.00
QSRA3060	60"W x 30"D x 22-32"H	\$1,084.00
QSRA3072	72"W x 30"D x 22-32"H	\$1,138.00

FEATURES



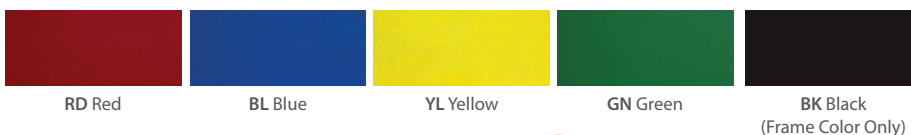







- Integrated full-length steel frame
- J-Channel apron provides superior inner support for a solid top
- Maximum support from integrated steel ladder frame underneath the top
- Constructed with heavy-duty materials
- Made in the U.S.A.



QS = QUICKSHIP

Note: R2448, R3060, RA2448 & RA3060 can be shipped by a small package carrier.

MELAMINE FOLDING TABLES

QSCF1860M	60"W x 18"D x 29"H	40 lbs.	\$636.00	
QSCF1872M	72"W x 18"D x 29"H	44 lbs.	\$663.00	
QSCF1896M	96"W x 18"D x 29"H	49 lbs.	\$752.00	
QSCF2448M	48"W x 24"D x 29"H	42 lbs.	\$586.00	
QSCF2460M	60"W x 24"D x 29"H	48 lbs.	\$663.00	
QSCF2472M	72"W x 24"D x 29"H	52 lbs.	\$698.00	
QSCF2496M	96"W x 24"D x 29"H	65 lbs.	\$760.00	
QSCF3060M	60"W x 30"D x 29"H	53 lbs.	\$650.00	
QSCF3072M	72"W x 30"D x 29"H	61 lbs.	\$684.00	
QSCF3096M	96"W x 30"D x 29"H	80 lbs.	\$787.00	
QSCF60MR	60"W x 60"D x 29"H	86 lbs.	\$1,234.00	

FEATURES

- Melamine top on 5/8" high density particle board core
- 1", 18 ga. steel pedestal legs on rectangular table tops
- 1 1/8", 14 ga. steel wishbone legs on round table bases
- Automatic lock-open mechanism
- Economical choice for light-duty home, office or retail use
- Made in the U.S.A.

Note: CF1860M, CF1872M, CF2448M, CF2460M & T6060 can be shipped by a small package carrier. 

TABLE CARTS



Flat Stacking Rectangular Table Cart

QST3072
72"W x 30"D x 37 1/4"H
List: \$1,262.00

QST3096
90"W x 30"D x 37 1/4"H
List: \$1,323.00
Available in BR Brown Only



Edge Stacking Round Table Cart

QST6060
48"W x 28"D x 31"H
List: \$1,387.00

Available in BR Brown Only



CF2448M - 48"W
Shown in Medium Oak



CF1860M - 60"W
Shown in Walnut



CF3096M - 96"W
Shown in Gray Granite



CF60MR - 60"W
Shown in Black Granite

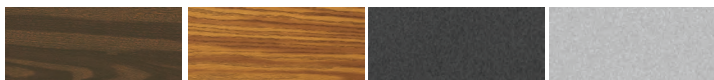

WB Walnut
w/Brown Frame
(Black T-Mold)

OB Medium Oak
w/Brown Frame
(Brown T-Mold)

BM Black Granite
w/Black Frame
(Black T-Mold)

GA Gray Granite
w/Gray Frame
(Gray T-Mold)

QS = QUICKSHIP



INTEGRATE

Pictured w/OS Pedestal Tables & OS Reception Glass Tables

A Armless Chair 9780A

Overall: 24"W x 29½"D x 32"H
Seat: 24"W x 20"D x 20"H
List: \$1,335.00

Note: All chairs come standard with silver post legs & ganging hardware is included.

B Chair Arm 972ARMA

Overall: 5½"W x 29½"D x 26"H
List: \$430.00

C Armless Wedge Chair w/Back on Large Side 9785A

Overall: 30¼"W x 29½"D x 32"H
Seat: 24"W x 21½"D x 20"H
List: \$1,353.00



BK Black
Antimicrobial
PU Leather

Some items in this collection come ready-to-assemble.



Pictured w/OS Pedestal Tables, OS Laminate Reception & Crusader Seating



DRAPER

Pictured w/OS Reception Glass Table

A Sofa w/Silver Metal Legs 9074F

Overall: 66"W x 30¾"D x 32¼"H
 Seat: 56¾"W x 20½"D x 19"H
 List: \$2,685.00

B Club Chair w/Silver Metal Legs 9071F

Overall: 30¾"W x 30¾"D x 32¼"H
 Seat: 21¼"W x 20½"D x 19"H
 List: \$1,433.00



TP Taupe Fabric



BK Black Fabric



GN Kashmir Green Fabric



Pictured w/OS Reception Laminate Table



Pictured w/Parallel Tables



MILLENNIAL

Pictured w/OS Pedestal Tables

**A Armless Chair w/Silver Metal Legs
10511V**

Overall: 26³/₈"W x 26³/₈"D x 30¹/₂"H
List: \$1,005.00

**B Corner Chair w/Silver Metal Legs
10519V**

Overall: 26³/₈"W x 26³/₈"D x 30¹/₂"H
List: \$1,101.00

**C Guest Chair w/Silver Metal Legs
10520V**

Overall: 29¹/₈"W x 27¹/₂"D x 30¹/₂"H
List: \$1,218.00

**D Ottoman w/Silver Metal Legs
10515V**

Overall: 26³/₈"W x 24¹/₂"D x 17¹/₂"H
List: \$681.00

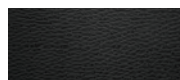

BK Black PU Leather

Note: All chairs include ganging brackets.

Note: All items on this page can be shipped by a small package carrier.





TRIBECA

Pictured w/OS Reception Laminate Table & Tre Seating

A Sofa w/Silver Metal Legs

9683A

Overall: 71¼"W x 29"D x 32"H

Seat: 61¾"W x 20"D x 17½"H

List: \$3,415.00

B Loveseat w/Silver Metal Legs

9682A

Overall: 51½"W x 29"D x 32"H

Seat: 42"W x 20"D x 17½"H

List: \$2,595.00

C Club Chair w/Silver Metal Legs

9681A

Overall: 31½"W x 29"D x 32"H

Seat: 21"W x 20"D x 17½"H

List: \$1,844.00



BK Black Finish
(Tablet Arm Only)



BK Black
Antimicrobial
PU Leather



GT Light Gray
Antimicrobial
PU Leather

ADDITIONAL PRODUCTS



D

*Tablet Rotates
A Complete 360
Degree Swivel*

D Club Chair w/Black Finished Tablet Arm & Silver Metal Legs

9681TAA

Overall: 31½"W x 29"D x 32"H

Seat: 21"W x 20"D x 17½"H

Tablet Arm: 15¾"W x 11¾"D x 26½"H

List: \$2,204.00



A

C

B

Pictured w/Parallel Tables

MANHATTAN

Pictured w/OS Pedestal Table & C-Table

A Sofa w/Black Wood Legs

9883L

Overall: 75"W x 32½"D x 31"H

Seat: 62"W x 20½"D x 19½"H

List: \$3,423.00

B Loveseat w/Black Wood Legs

9882L

Overall: 55"W x 32½"D x 31"H

Seat: 42"W x 20½"D x 19½"H

List: \$2,719.00

C Club Chair w/Black Wood Legs

9881L

Overall: 34"W x 32½"D x 31"H

Seat: 20½"W x 20½"D x 19½"H

List: \$1,872.00

FEATURES

- Cushioned top grain leather upholstery
- Heavy-duty pocket spring coil construction
- Webbed seat & back
- Black wood finished legs



LT Latte
Top Grain Leather

BK Black
Top Grain Leather

ADDITIONAL PRODUCTS

Laminate Side C-Table w/Silver Base

PLTC66T†

22¼"W x 15¾"D x 25½"H

List: \$375.00



For more details on this product, See Page 128

Note: American Elm only available for select SKUs. Select SKUs are notated by a † mark at the end of their SKU.



Pictured w/OS Pedestal Table & C-Table



MADISON

Pictured w/OS Reception Glass Table

**A Sofa w/Chrome Frame
9283A**

Overall: 76"W x 32"D x 27"H
Seat: 63"W x 22"D x 17¾"H
List: \$4,225.00

**B Loveseat w/Chrome Frame
9282A**

Overall: 55"W x 32"D x 27"H
Seat: 41¾"W x 22"D x 17¾"H
List: \$3,229.00

**C Club Chair w/Chrome Frame
9281A**

Overall: 34½"W x 32"D x 27"H
Seat: 21"W x 22"D x 17¾"H
List: \$2,256.00



BK Black
Antimicrobial
PU Leather



GT Light Gray
Antimicrobial
PU Leather



Pictured w/OS Reception Laminate Table & OS Laminate Storage



STERLING

Pictured w/OS Reception Glass Tables

A Sofa w/Brushed Chrome Legs
62621L

Overall: 79½"W x 33⅞"D x 32⅛"H

Seat: 66⅞"W x 20½"D x 17⅞"H

List: \$3,486.00

B Loveseat w/Brushed Chrome Legs
62611L

Overall: 58⅛"W x 33⅞"D x 32⅛"H

Seat: 44⅞"W x 20½"D x 17⅞"H

List: \$2,489.00

C Club Chair w/Brushed Chrome Legs
62601L

Overall: 35⅛"W x 33⅞"D x 32⅛"H

Seat: 23¼"W x 20½"D x 17⅞"H

List: \$1,680.00



BK Black PU Leather

Note: 62601L can be shipped by a small package carrier. 📦

FRAMED

A Club Chair w/Matte Black Metal Frame
9285F

Overall: 34¼"W x 32"D x 27"H

Seat: 20⅞"W x 22½"D x 17¾"H

List: \$1,887.00



GT Light Gray Fabric





DEFINE

**A Sofa w/Silver Metal Legs
9703V**
Overall: 73"W x 32"D x 31"H
Seat: 64½"W x 20½"D x 18½"H
List: \$2,615.00

**B Loveseat w/Silver Metal Legs
9702V**
Overall: 50"W x 32"D x 31"H
Seat: 43"W x 20½"D x 18½"H
List: \$2,028.00

**C Club Chair w/Silver Metal Legs
9701V**
Overall: 31¼"W x 32"D x 31"H
Seat: 23"W x 20½"D x 18½"H
List: \$1,371.00



BK Black PU Leather



GR Gray PU Leather



PARTRIDGE

A Sofa w/Light Wood Legs

50621F

Overall: 79¹/₁₆"W x 30³/₈"D x 32¹/₁₆"H

Seat: 70⁷/₈"W x 18¹/₁₆"D x 17¹/₁₆"H

List: \$3,059.00

B Loveseat w/Light Wood Legs

50611F

Overall: 58¹/₁₆"W x 30³/₈"D x 32¹/₁₆"H

Seat: 47¹/₄"W x 18¹/₁₆"D x 17¹/₁₆"H

List: \$2,391.00

C Club Chair w/Light Wood Legs

50601F

Overall: 35⁷/₈"W x 30³/₈"D x 32¹/₁₆"H

Seat: 23³/₈"W x 18¹/₁₆"D x 17¹/₁₆"H

List: \$1,590.00

Note: 50601F can be shipped by a small package carrier. 📦



GR Gray Linen Fabric



LT Latte Fabric



PARTRIDGE



Pictured w/Palissades Tables



GR Gray Linen Fabric



LT Latte Fabric



NEW! MIRA

Pictured w/Parallel Table

**Wood Arm Upholstered
Lounge Chair
OSRL3001**

Overall: 29 1/8"W x 32 5/16"D x 35"H

Seat: 29 1/8"W x 20 1/2"D x 18 1/2"H

List: \$1,980.00



PB Pebble Fabric



CR Charcoal Fabric



CHAIR FEATURES

Bottom and back cushions are attached for a seamless design



Beautifully crafted, solid hardwood frame, legs and arms creates a contemporary and timeless style



Sinuous spring and web suspension with premium, high-density foam and fiber cushions

Textured weave fabric available in two fashionable colors

Fully Upholstered & Seamless Back

Ships Fully Assembled

Tapered Legs & Sloped Arms Offers A Contemporary Appeal





NEW! REMINGTON

Pictured w/OS Reception Laminated Table & Hairpin Legs

Wingback Upholstered Lounge Chair OSRL3002

Overall: 28⁵/₁₆"W x 33"D x 39"H
 Seat: 28⁵/₁₆"W x 33⁹/₁₆"D x 39⁷/₁₆"H
 List: \$1,196.00



TF Toffee PU Leather



CR Charcoal PU Leather



CHAIR FEATURES



Sleek and detailed back tufting with precision stitching



Durable and expertly crafted legs made from solid hardwood construction for long-lasting use



Sinuous spring and web suspension with premium, high-density foam and fiber cushions

Upholstered in a soft PU leather for a luxurious seating experience



*Low-Rise Arms
With A Round Wingback Design*



Fully Upholstered Backside



Some Assembly Required



DOVER

Pictured w/OS Pedestal Tables

A Designer Guest Chair w/Wood Frame

1700F (Fabric)

1700V (Vinyl)

Overall: 22"W x 25"D x 31¼"H

Seat: 19½"W x 19½"D x 19"H

List: \$574.00

Note: Must order Frame & Upholstery Choice.

B Designer Half Arm 1700SHA*

Overall: 20½"W x 1¾"D x 24½"H

List: \$211.00



DESIGNER ARM FEATURES

*Half arms are used with two chairs or more to create a multi-seat unit with no visible arm obstruction

**Full arms are used with two chairs or more to create a multi-seat unit with visible arm obstruction

ADDITIONAL PRODUCTS

Designer Full Arm

1700FA**

Overall: 20½"W x 1¾"D x 25½"H

List: \$245.00



Frame Finishes



CG Coastal Gray



ES Espresso

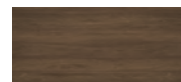

MW Modern Walnut



MH Mahogany



CH Cherry

Upholstery Colors



BK Black Fabric



BK Black Bonded Leather



CHELSEA

Pictured w/Parallel Tables

A Designer Guest Chair w/Wood Frame

1600F (Fabric)

1600V (Vinyl)

Overall: 23½"W x 23½"D x 34"H

Seat: 20"W x 19½"D x 18½"H

List: \$600.00

Note: Must order Frame & Upholstery Choice.

B Designer Full Arm 1600FA**

Overall: 22"W x 2"D x 26½"H

List: \$259.00

ADDITIONAL PRODUCTS

Designer Half Arm 1600SHA*

Overall: 22"W x 1½"D x 24½"H

List: \$222.00



DESIGNER ARM FEATURES

*Half arms are used with two chairs or more to create a multi-seat unit with no visible arm obstruction



**Full arms are used with two chairs or more to create a multi-seat unit with visible arm obstruction

Frame Finishes



CG Coastal Gray



ES Espresso

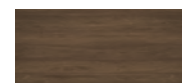

MW Modern Walnut



MH Mahogany



CH Cherry

Upholstery Colors



BK Black Fabric



BK Black Bonded Leather

BOWERY

From boardrooms and office rooms to dining rooms and healthcare, the Bowery is designed for comfort and durability. Crafted using solid exposed wood and full suspension, our guest seating can provide comfort and style.



A Retro Style Guest Chair w/Wood Legs
6909F (Fabric w/Black Wood Legs)
6909V (Vinyl w/Mahogany Wood Legs)
 Overall: 24½"W x 25½"D x 35½"H
 Seat: 19½"W x 20"D x 19"H
 List: \$669.00



B Barrel Back Guest Chair w/Black Wood Legs
5209F (Fabric)
5209V (Vinyl)
 Overall: 25½"W x 29"D x 28"H
 Seat: 25½"W x 21"D x 19"H
 List: \$884.00



Beautifully Rounded & Fully Upholstered Backside



GR Gray Linen
Fabric

BK Black
PU Leather

Note: Bowery chairs on this page can be shipped by a small package carrier. 📦

SPENCER



**Guest Chair w/Mahogany Frame
1240V**
Overall: 26"W x 28"D x 36"H
Seat: 21"W x 20½"D x 19"H
List: \$669.00



BK Black
Leather Soft Vinyl

This product is part of a complete collection.
See Page 207



Note: Spencer chair on this page can be shipped by a small package carrier. 📦

ADLEY



**Guest Chair w/Light Wood Legs
05AD2JMGV**
Overall: 26¼"W x 26⅝"D x 31¼"H
Seat: 20½"W x 19¾"D x 18½"H
List: \$721.00

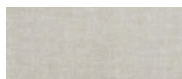

CE Cream Vinyl



Exposed Back Cushion To Help Prevent Heat & Moisture Build Up With Padded Armrests



CHAIR FEATURES

Textured feel that looks like linen despite being vinyl upholstery



Boxed arm design with attractive light wood legs creates a contemporary feel perfect for your office or home

Note: Adley on this page can be shipped by a small package carrier. 📦

BOLSTER



**Mid Back Swivel Chair
w/5 Star Chrome Base
12887F**

Overall: 29³/₁₆"W x 28³/₄"D x 33⁷/₁₆-37¹/₁₆"H
Seat: 17³/₄"W x 18¹/₁₆"D x 18¹/₈-21¹/₁₆"H
List: \$960.00

*Functions: Adjustable Seat Height,
360 Degree Swivel, Tilt Tension, Tilt-Lock*



**Mid Back Guest Chair
w/Light Wood Leg Base
12881F**

Overall: 29³/₁₆"W x 26¹/₁₆"D x 35¹/₁₆"H
Seat: 18¹/₂"W x 18¹/₁₆"D x 19⁵/₁₆"H
List: \$907.00

Note: Bolster can be shipped by a small package carrier. 📦



**Mid Back Guest Chair
w/Black Metal Sled Base
12885F**

Overall: 29³/₁₆"W x 26⁵/₁₆"D x 35¹/₁₆"H
Seat: 17³/₄"W x 18¹/₁₆"D x 19⁵/₁₆"H
List: \$810.00



GR Gray Linen Fabric

KINSLEY



**Modern Guest Chair
w/Black Metal Legs
05KI25MGF**

Overall: 23¹/₄"W x 24³/₈"D x 31⁵/₈"H
Seat: 20¹/₂"W x 18¹/₈"D x 18⁷/₈"H
List: \$715.00



GR Gray Linen Fabric

Note: Kinsley can be shipped by a small package carrier. 📦

ROUND



**Swivel Club Chair
3385V**

Overall: 31"W x 28¹/₂"D x 29³/₄"H
Seat: 21¹/₄"W x 21¹/₄"D x 18³/₄"H
List: \$1,380.00



BK Black PU Leather



UNIQUE FEATURES

Sturdy, durable black metal base with a complete 360 Degree Swivel complements the contemporary, timeless look

TATE



Guest Chair w/Arms & Black Frame 18925V

Overall: 25 $\frac{1}{8}$ "W x 23 $\frac{7}{8}$ "D x 35 $\frac{1}{2}$ "H
 Seat: 20"W x 20 $\frac{7}{8}$ "D x 18 $\frac{1}{8}$ "H
 List: \$588.00



BK Black PU Leather

Note: Tate can be shipped by a small package carrier. 📦

EBONY



Guest Chair w/Black Frame 769A

Overall: 22 $\frac{7}{16}$ "W x 25 $\frac{3}{16}$ "D x 34 $\frac{7}{16}$ "H
 Seat: 20 $\frac{1}{2}$ "W x 19"D x 18 $\frac{1}{16}$ "H
 List: \$469.00



BK Black Vinyl

Note: Ebony can be shipped by a small package carrier. 📦



Pictured w/OS Laminate - OS263 Typical



Wall Saver
Back Leg Design

NEW! INTERCHANGEABLE



Black Mesh Back
(Shown Without Arms)



Gray Mesh Back
w/Optional "Z" Armrests
(Shown Using Included Arms)



Sled base with black floor glides to prevent scratching or marring of floor surfaces

This product is part of a complete collection.
See Pages 178-179

Gray or Black Mesh Back, Armless Guest Chair w/Sled Base

6569MGF (Gray Mesh Back)
 6569MBF (Black Mesh Back)
 Overall: 25 $\frac{1}{16}$ "W x 19 $\frac{1}{2}$ "D x 39 $\frac{5}{8}$ "H
 Seat: 19 $\frac{5}{16}$ "W x 19 $\frac{1}{16}$ "D x 18 $\frac{3}{4}$ "H
 List: \$610.00



BK Black Fabric Seat



CHAIR FEATURES

Optional "Z" padded armrests are included with both colors - create a guest chair with or without arms

Guest chair provides back lumbar support to give your guest the comfort they deserve while sitting



NEW! JOLA

Pictured w/NEW! OSTYP331 Typical

Fabric Guest Chair w/Black Metal Base OSGS4001

Overall: 22 $\frac{1}{6}$ "W x 19 $\frac{3}{4}$ "D x 30 $\frac{3}{4}$ "H

Seat: 19 $\frac{3}{4}$ "W x 17 $\frac{3}{4}$ "D x 30 $\frac{1}{6}$ "H

List: \$1,560.00 ctn.

Note: Priced and sold as (2) per carton.



UNIQUE FEATURES

Unique, cross-stitching detail adds high-end appeal for your gathering or collaboration areas



CN Crimson Fabric



AP Asphalt Fabric

Guest chairs include black floor glides to prevent scratching or marring of floor surfaces



MATCHING STOOL

Bar Height - See Page 166





A

WILLOW

Pictured w/NEW! OSTYP330 Typical & Tribeca Seating

A Mid Back Guest Chair w/Black Metal Sled Base 06WI2WMGSBF

Overall: 19¾"W x 22"D x 31¾"H

Seat: 19¾"W x 16½"D x 18½"H

List: \$585.00 ea.

Note: Priced as each & sold in increments of (2).

B Mid Back Guest Chair w/Black Metal Leg Base 06WI2WMGPLF

Overall: 19¾"W x 22"D x 31¾"H

Seat: 19¾"W x 16½"D x 18½"H

List: \$585.00 ea.

Note: Priced as each & sold in increments of (2).



BL Blue Fabric



GR Gray Fabric

Note: Willow on this page can be shipped by a small package carrier. 📦



MATCHING STOOL

Café Height - See Page 167





Pictured w/OS Pedestal Tables

VALUE

A Sled Base Fabric Guest Chair w/Black Frame

2708F

Overall: 24"W x 25"D x 34½"H
 Seat: 20"W x 19"D x 18"H
 List: \$368.00

Armless, Sled Base Fabric Guest Chair w/Black Frame

2709F

Overall: 24"W x 25"D x 34½"H
 Seat: 20"W x 19"D x 18"H
 List: \$339.00

B Sled Base Vinyl Guest Chair w/Black Frame

2748A

Overall: 24"W x 25"D x 34½"H
 Seat: 20"W x 19"D x 18"H
 List: \$399.00



BK Black Fabric
(2708F & 2709F Only)



NV Navy Fabric
(2708F Only)



BK Black Antimicrobial PU leather
(2748A Only)

Note: Value chairs on this page can be shipped by a small package carrier. 📦

MERIT

A Sled Base Guest Chair w/Arms & Black Frame

315V

Overall: 23"W x 24½"D x 34"H
 Seat: 20"W x 20"D x 18½"H
 List: \$359.00

B Armless, Sled Base Guest Chair w/Black Frame

314V

Overall: 23"W x 24½"D x 34"H
 Seat: 20"W x 20"D x 18½"H
 List: \$343.00



BK Black Leather Soft Vinyl

Note: Merit chairs on this page can be shipped by a small package carrier. 📦



Pictured w/Matching Blow Mold Folding Tables - See Page 132

BLOW MOLD FOLDING CHAIR



Plastic Folding Chair w/Gray Frame FBM03*

List: \$596.00 ctn.
Note: FBM03 Priced (4) Per Carton.



GR Gray Plastic



Black Folding Chair Cart FCDRA51

(Holds up to (30) FBM03
or (72) 1601 & 1631)
67"W x 31"D x 70"H
List: \$1,138.00

CHAIR FEATURES

Hand indentation for easy portability on the back of the chair

Strong, durable frame can hold up to 275 lbs. of weight and folds for easy storage

STEEL FOLDING CHAIRS



A All Steel Folding Chair 1601*

List: \$365.00 ctn.
Note: 1601 & 1631 Priced (4) Per Carton.

B Steel Folding Chair w/Padded Seat & Back 1631V*

List: \$467.00 ctn.



BK Black Steel



GR Gray Steel



BK Black Vinyl
(1631 Only)

Note: FBM03, 1601 & 1631 can be shipped by a small package carrier. 📦

*Note: Chairs cannot be sold in singles.



STACKS
16
↑

Weight Capacity
300 LBS



STACKS
16
↑

Weight Capacity
300 LBS



STACKS
12
↑
ON DOLLY

A Square Back Stacker w/Black Stipple Steel Frame 10RE1SWMSV
Weight Capacity: 300 LBS
Overall: 17"W x 21"D x 37"H
Seat: 16"W x 16"D x 18"H
List: \$221.00

B High Back Stacker Banquet Chair w/Black Stipple Steel Frame 10BA1WMSF
Weight Capacity: 300 LBS
Overall: 17"W x 21"D x 37"H
Seat: 16"W x 16"D x 18"H
List: \$228.00

C Black Chair Dolly 10STKDOLLY
(Holds up (12) Chairs Only)
Overall: 20"W x 32½"D x 48"H
List: \$493.00

Note: 10STKDOLLY can be shipped by a small package carrier.

FEATURES

- High density, 2" thick seat cushion
- Nylon rocker glides and stack bumpers
- 16-Gauge steel tubing frame
- Baked powder epoxy finish



BK Black Vinyl
(10RE1SWMSV)
(Chair A Only)

BK Black Fabric
(10BA1WMSF)
(Chair B Only)



Black Stipple Frame

Items in this collection come fully assembled.





AERO

Pictured w/Optional Casters & OS Training Tables



A Armless Guest Chair w/Black Seat & Titanium Frame

3220TGF

Overall: 20½"W x 23¼"D x 33½"H

Seat: 18"W x 19¼"D x 18½"H

List: \$347.00

**STACKS
4
HIGH**



B Guest Chair w/Arms, Black Seat & Titanium Frame

3204TGF

Overall: 23¾"W x 23¼"D x 33½"H

Seat: 18"W x 19¼"D x 18½"H

List: \$374.00

OPTIONAL CASTERS

(For 3220TG & 3204TG)

Casters (Set of 4)
2700CASTERS

List: \$58.00
(BK Black)



BK Black Fabric

Note: 2700CASTERS can be shipped by a small package carrier. 📦



MARIO

A All Charcoal Stackable Student Desk w/Chrome Frame 6080
 26¹³/₁₆"W x 22¹/₁₆"D x 28¹/₄"H
 List: \$417.00

B All Charcoal Armless Stackable Student Chair w/Chrome Frame 6070
 Overall: 20⁵/₁₆"W x 20¹/₂"D x 31¹/₁₆"H
 Seat: 17¹/₁₆"W x 16³/₁₆"D x 17⁷/₁₆"H
 List: \$278.00



UNIQUE FEATURES

Student desks come with a pencil holder, modesty panel and slide-out hook on both sides for your personal bags

Note: Chairs & desks include ganging brackets.

STACKS
 H
 G
 H
 6 ↑



CR Charcoal Plastic Back & Seat

Most Items in this collection come fully assembled.

Note: Products A, B & C on this page can be shipped by a small package carrier. 📦

ADDITIONAL PRODUCTS



STACKS
 H
 G
 H
 12 ↑
 ON DOLLY

C Silver Desk Dolly 6080DOLLYSI
 (For 6080 Desks)
 32¹/₁₆"W x 27¹/₁₆"D x 22¹/₁₆"H
 List: \$417.00

D Silver Chair Dolly 6070DOLLYSI
 (For 6070 Chairs)
 17"W x 30"D x 24¹/₄"H
 List: \$290.00



ZELLA

Pictured w/OS Multi-Purpose Laminate Tables

A Stackable Chair w/Chrome Frame 6054

Overall: 23¾"W x 22¼"D x 31¼"H

Seat: 16"W x 16½"D x 17½"H

List: \$404.00



BK Black Plastic

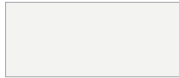

WH White Plastic

Note: Zella on this page can be shipped by a small package carrier. 📦

B Optional Top Cushion 6054CUSHF

Overall: 15¾"W x 16½"D x 1½"H

List: \$106.00



UNIQUE FEATURES

No tools are necessary for the optional seat cushion, attaches with double-faced tape

Top Cushion Upholstery



BK Black Fabric



CR Charcoal Fabric

STACKS
5 HIGH ↑

Shown w/Black Optional Seat Cushion





SLASH

Pictured w/OS Multi-Purpose Tables & OSC16 Typical

A Armless Stacking Guest Chair w/Chrome Sled Base

3040SB

Overall: 21"W x 21¾"D x 32¼"H

Seat: 18"W x 16"D x 16¾"H

List: \$233.00

B Armless Stacking Guest Chair w/Chrome Frame

3040PL

Overall: 21"W x 21¾"D x 32¾"H

Seat: 18"W x 16"D x 17"H

List: \$233.00



BK Black Plastic

NV Navy Plastic



TOWER

A Stackable Guest Chair w/Chrome Frame

SC1400

Overall: 18½"W x 18"D x 32½"H

Seat: 18½"W x 18"D x 18"H

List: \$236.00

B Black Chair Dolly

D100

(For SC1400)

22"W x 23"D x 19"H

List: \$270.00



BK Black Plastic

Most items in this collection come fully assembled.



Note: SC1400 on this page can be shipped by a small package carrier. 📦



STACKED SEATING

Pictured w/OS Multi-Purpose Tables & Rise Seating - NEW! OSTYP314 Typical

A Stackable Guest Chair w/Arms & Chrome Frame (Black Only)

3081

Overall: 24½"W x 22¾"D x 31"H

Seat: 18"W x 16¾"D x 17¾"H

List: \$238.00

Note: 3081 does not gang together.

B Armless Stackable Guest Chair w/Chrome Frame

3080

Overall: 20¾"W x 22¾"D x 32¼"H

Seat: 18"W x 16¾"D x 17¾"H

List: \$188.00

C Black Chair Dolly 3080DOLLYBK

(For 3080 & 3081)

22¾"W x 25"D x 14"H

List: \$178.00



STACKS
12
HIGH
BOTH CHAIRS



STACKS
16
HIGH
ON DOLLY



NV Navy Plastic

BL Light Blue Plastic

BK Black Plastic
(3081 Only)

WH White Plastic

Most Items in this collection come fully assembled.

Note: 3080DOLLY on this page can be shipped by a small package carrier. 📦

PARSON

A Micro Mesh Back Guest Chair w/Arms & Black Frame

Overall: 22½"W x 23¼"D x 33½"H
 Seat: 18½"W x 18½"D x 18¼"H
3128GNSF (Fabric) List: \$435.00
3128GNSA (Vinyl) List: \$487.00

B Armless Micro Mesh Back Guest Chair w/Black Frame

Overall: 22½"W x 23¼"D x 33½"H
 Seat: 18½"W x 18½"D x 18¼"H
3129GNSF (Fabric) List: \$427.00
3129GNSA (Vinyl) List: \$479.00



Pictured w/Optional Casters - OSC31 Typical



FEATURES

- Ergonomic design with an eye catching look
- Optimal comfort through ideal seating dimensions
- Optional casters provides mobility when you need it



BK Black
Antimicrobial
PU Leather

OPTIONAL CASTERS

(For 3128GNS & 3129GNS)

Casters (Set of 4)
2700CASTERS

List: \$58.00
(BK Black)



Note: Parson on this page can be shipped by a small package carrier. 📦

CROSSWAY

A Mesh Back Guest Chair w/Arms & Black Frame

Overall: 24"W x 24"D x 33"H
 Seat: 18"W x 18"D x 19½"H
2029F (Fabric Seat) List: \$285.00
2029V (Vinyl Seat) List: \$290.00

B Mesh Back Armless Guest Chair w/Black Frame

Overall: 24"W x 24"D x 33"H
 Seat: 18"W x 18"D x 19½"H
2028F (Fabric Seat) List: \$270.00
2028V (Vinyl Seat) List: \$275.00



BK Black Fabric

BK Black
Leather Soft Vinyl



Shown w/Black Fabric



Shown w/Black Leather Soft Vinyl

Note: Crossway on this page can be shipped by a small package carrier. 📦

This product is part of a complete collection.
See Page 191

CARSON

STACKS
4 HIGH



**Mesh Back Guest Chair w/Black Frame
18929F**
Overall: 25"W x 23¼"D x 33¼"H
Seat: 20"W x 20½"D x 19¾"H
List: \$559.00

**OPTIONAL
CASTERS**

(For 18929 Only)

**Casters (Set of 4)
18929CASTERS**

List: \$64.00
(BK Black)



BK Black Fabric



Shown w/Optional Casters

Note: Carson chair can be shipped by a small package carrier. 📦

LEVY



**Stacking Guest Chair
w/Arms & Black Frame
1022V**

Overall: 23½"W x 23"D x 30½"H
Seat: 18"W x 18"D x 18"H
List: \$236.00



BK Black
Leather Soft Vinyl



STACKS
4 HIGH



UNIQUE FEATURES

Designed with a unique waterfall front seat cushion that helps to prevent leg fatigue for your guests while sitting



Note: Levy chair on this page can be shipped by a small package carrier. 📦



PERCH

Pictured w/OS Multi-Purpose Tables & OSC12 Typical

A Armless Nesting Chair w/Casters & Titanium Frame
 Overall: 22½"W x 21½"D x 34½"H
 Seat: 18½"W x 19"D x 19"H
3274TNSF (Fabric) List: \$483.00
3274TNSA (Vinyl) List: \$522.00

B Nesting Chair w/Arms, Casters & Titanium Frame
 Overall: 24"W x 21½"D x 34½"H
 Seat: 18½"W x 19"D x 19"H
3294TNSF (Fabric) List: \$524.00
3294TNSA (Vinyl) List: \$563.00

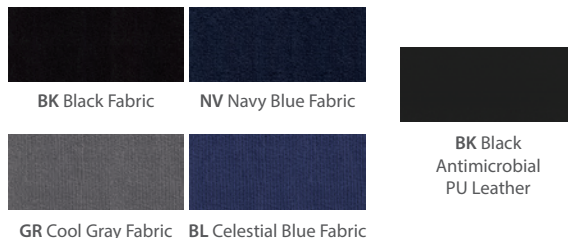

Nesting

Note: Perch can be shipped by a small package carrier. 📦



JULEP

Pictured w/OS Training Tables

A Nesting Chair w/Arms, Casters & Black Frame

5494NSF

Overall: 24½"W x 23¼"D x 36"H

Seat: 17¾"W x 18¼"D x 19"H

List: \$505.00

B Armless Nesting Chair w/Casters & Black Frame

5474NSF

Overall: 22½"W x 23¼"D x 36"H

Seat: 17¾"W x 18¼"D x 19"H

List: \$461.00



BK Black Fabric

GR Cool Gray Fabric

BL Celestial Blue Fabric



CHAIR DESIGN

Flex back design allows user to lean back in this chair



Note: Julep can be shipped by a small package carrier. 📦

TRIUMPH

Armless Nesting Flex Back Chair w/Casters & Black Frame

90094NSF

Overall: 23⅞"W x 21⅝"D x 33⅙"H

Seat: 17"W x 17"D x 19"H

List: \$858.00



Pictured w/OS Multi-Purpose Glass Table & Optional Armrests



Nesting



BK Black Fabric

OPTIONAL ARM RESTS

(For 90094NS Only)

Plastic Arm Rest

(Set of 2)

90094A

List: \$87.00

(BK Black)



Note: 90094NSF on this page can be shipped by a small package carrier. 📦



NEW! JOLA

Pictured w/NEW! Sofia Collaboration Table w/NEW! American Elm Top

Bar Height Fabric Stool w/Black Metal Base OSST7001

Overall: 22 $\frac{1}{16}$ "W x 20 $\frac{1}{2}$ "D x 42 $\frac{1}{16}$ "H

Seat: 19 $\frac{3}{4}$ "W x 17 $\frac{3}{4}$ "D x 18 $\frac{3}{16}$ "H

List: \$1,720.00 ctn.

Note: Priced and sold as (2) per carton.



CN Crimson Fabric



AP Asphalt Fabric



CHAIR FEATURES

Black metal base offers stability and durability with a built-in footrest



Contemporary design with a unique pass-through seat that provides easy cleaning



MATCHING GUEST CHAIR

This product is part of a complete collection.
See Page 152



WILLOW

Pictured w/OS Multi-Purpose Tables - NEW! OSTYP315 Typical

**Café Height Bistro Stool
w/Black Steel Base**
06W12JLSF

Overall: 21¹¹/₁₆"W x 22¹¹/₁₆"D x 38"H
Seat: 19¹/₈"W x 16³/₁₆"D x 30³/₈"H
List: \$597.00

Note: Priced as each & sold in increments of (2).



BL Blue Fabric



GR Gray Fabric

Note: Willow can be shipped by a small package carrier.



**MATCHING
GUEST CHAIR**

This product is part of a complete collection.
See Page 153



Pictured w/OS Multi-Purpose Tables - NEW! OSTYP330 Typical



COLOR STACK

Pictured w/OS Multi-Purpose Tables

A Mesh Stool w/Painted Frame 629M

Overall: 22³/₁₆"W x 23³/₁₆"D x 44¹/₁₆"H
 Seat: 17¹/₁₆"W x 19³/₁₆"D x 30⁷/₁₆"H
 List: \$557.00

B Mesh Stack Chair w/Painted Frame 628M

Overall: 20⁷/₁₆"W x 21⁵/₁₆"D x 32¹/₂"H
 Seat: 17¹/₁₆"W x 19³/₁₆"D x 18¹/₁₆"H
 List: \$417.00

Note: 628M on this page can be shipped by a small package carrier. 📦



UNIQUE FEATURES

Soft mesh backrest and seat provides tension, balance, flexibility & air permeability with a painted matching metal frame for durability



Both chairs include clear floor glides on the bottom to protect your floors from surface scratches

STACKS
4 HIGH



BK Black Mesh



RD Red Mesh

Stacks to 4 High - 628M Only



RISE STOOL

Pictured w/OS Standing Tables - See Page 35

Polyurethane Stool w/Footrest & Chrome Base 3085STOOL

Overall: 20"W x 23"D x 43¾"H

Seat: 18"W x 17"D x 29"H

List: \$357.00

Note: 3085STOOL does not stack.

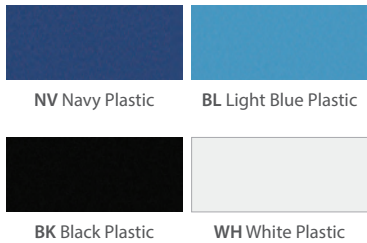

NEW! OSLO

Mesh Back Stool w/Arms & Black Frame

607MMF

Overall: 24⁵/₁₆"W x 24¹/₁₆"D x 44¹⁵/₁₆"H

Seat: 19¹/₄"W x 17³/₈"D x 29"H

List: \$520.00

Note: 607MMF does not stack.



Sturdy Metal Frame with Foot Support



Powder-Coated Aluminum Frame

Waterfall Front Edge Fabric Seating

MATCHING CHAIR FAMILY

Guest Chair - See Pages 176-177



BK Black Fabric w/Black Frame

CHAIR DESIGN

Durable, mesh back promotes airflow while providing optimal lumbar support



SPICE

Armless Mesh Back Task Stool w/Matte Black Footring & Titanium Steel Base

Overall: 25¹/₂"W x 25¹/₂"D x 42-51¹/₄"H

Seat: 20¹/₂"W x 19¹/₂"D x 24-33¹/₄"H

7851NSF (Fabric Seats) List: \$691.00

7851NSA (AM Vinyl & Fabric Seats) List: \$691.00

7851NSM (Mesh Seat) List: \$768.00

7851NSL (Leather Seat) List: \$790.00

Functions: Adjustable Seat Height, 360 Degree Swivel, Tilt-Tension, Tilt-Lock, Height & Width Adjustable Arms (Optional)



Seat Height: 24-33¹/₄"H

OPTIONAL ARMS

(For 7851NS)

Adjustable Arm Kit 311AK

List: \$157.00

(BK Black)



This product is part of a complete collection. See Page 189



Shown w/Optional Arm Kit

Note: Spice can be shipped by a small package carrier. 📦

OfficeSource® Spice Seat Type Options - Build Your Custom Chair



BK Black Fabric

NV Navy Blue Fabric

BL Celestial Blue Fabric

GR Cool Gray Fabric

AS Ash Gray Antimicrobial Fabric

BK Black Antimicrobial PU Leather

BK Top Grain Leather

RD Red Fabric

OR Orange Fabric

CO Cobalt Blue Antimicrobial Fabric

OL Olive Green Antimicrobial Fabric

BK Mesh

NP Neptune Antimicrobial PU Leather

Note: When selecting chair, please choose seat cushion.

COOLMESH PRO



Seat Height:
25 - 33½"H

Mesh Back Task Stool w/Adjustable Arms, Footring & Titanium Steel Base

Overall: 25½"W x 25¾"D x 41-49¾"H

Seat: 20½"W x 19½"D x 25-33½"H

8051ANSF (Fabric Seats) List: \$934.00

8051ANSA (AM Vinyl & Fabric Seats) List: \$934.00

8051ANSM (Mesh Seat) List: \$1,011.00

8051ANSL (Leather Seat) List: \$1,033.00

Functions: Adjustable Seat Height, 360 Degree Swivel, Ratchet Back, Height Adjustable Arms

This product is part of a complete collection. See Pages 182-183

Note: CoolMesh Pro can be shipped by a small package carrier. 📦

CHAIR DESIGN

Ratchet back with hard, durable frame provides long-lasting support

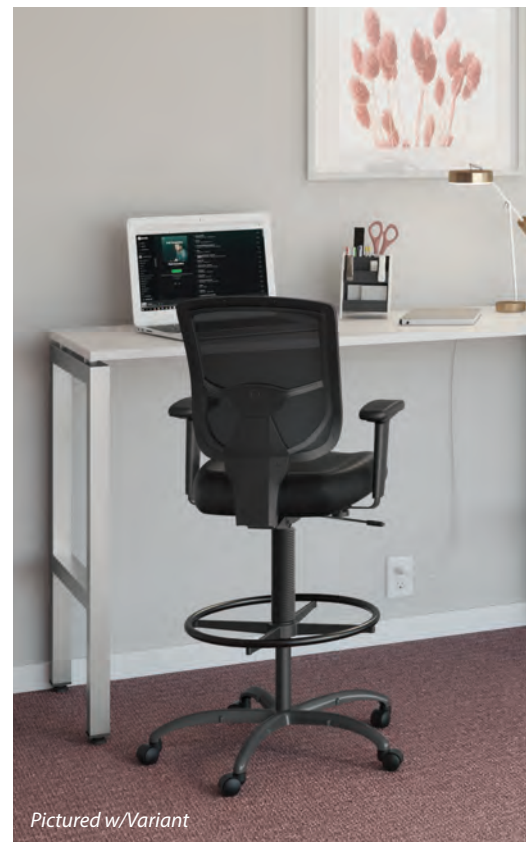

Pictured w/Variant



Shown w/Olive Green Antimicrobial Fabric Seat









Shown w/Black Leather Seat - Profile View



Shown w/Black Mesh Seat

OfficeSource® CoolMesh Pro Seat Type Options - Build Your Custom Chair

						
BK Black Fabric	NV Navy Blue Fabric	BL Celestial Blue Fabric	GR Cool Gray Fabric	AS Ash Gray Antimicrobial Fabric	BK Black Antimicrobial PU Leather	BK Top Grain Leather
						
RD Red Fabric	OR Orange Fabric	CO Cobalt Blue Antimicrobial Fabric	OL Olive Green Antimicrobial Fabric	BK Mesh	NP Neptune Antimicrobial PU Leather	

Note: When selecting chair, please choose seat cushion.

TASK FORCE



A Task Stool w/Footing & Chrome Base

6801FPFRA

Overall: 24¾"W x 27"D x 43"-46½"H

Seat: 19¾"W x 19"D x 26½"-30"H

List: \$852.00

Functions: Adjustable Seat Height, 360 Degree Swivel, Height Adjustable Arms



BK Black
Antimicrobial Vinyl

B Mid Back Task Chair w/Chrome Base

6801FPA

Overall: 24¾"W x 27"D x 36¾"-40¼"H

Seat: 19¾"W x 19"D x 18½"-22"H

List: \$733.00

Functions: Adjustable Seat Height, 360 Degree Swivel, Height Adjustable Arms



BK Black
Antimicrobial Vinyl



Note: All items for Task & Effort can be shipped by a small package carrier. 📦

TASK FORCE / EFFORT OPTIONS

OPTIONAL GLIDES

(For 316FR & 6801FPFR)

Glides (Set of 5) NORGLIDES

List: \$49.00

(BK Black)



OPTIONAL CASTERS

(For 316FR & 6801FPFR)

Soft Caster Kit (Set of 5) NORCASTER

List: \$62.00

(BK Black)



OPTIONAL ARMS

(For 316FR Only)

Adjustable Arm Kit B909JARM

List: \$148.00

(BK Black)



EFFORT

A Black Leather Armless Deluxe Posture Chair w/Footing & Black Base

316FRL

Overall: 25"W x 25"D x 44½"-49½"H

Seat: 20"W x 18"D x 26½"-31½"H

List: \$461.00

Functions: Adjustable Seat Height, Seat Depth Adjustment, 360 Degree Swivel



BK Black
Bonded Leather

B Black Leather Armless Deluxe Posture Chair w/Black Frame

316L

Overall: 25"W x 25"D x 35"-40"H

Seat: 17½"W x 16½"D x 18½"-23½"H

List: \$342.00

Functions: Adjustable Seat Height, Seat Depth Adjustment, 360 Degree Swivel



BK Black
Bonded Leather



MEDICAL STOOLS



Seat Height
w/Footing:
28 -34"H

Shown w/Optional Footring

**A Medical Stool w/Backrest & Polished Chrome Base
345FPA**

Overall: 25"Dia x 33½-39½"H
Seat: 16"Dia x 20½-26½"H
List: \$443.00

Functions: Adjustable Seat Height, 360 Degree Swivel



Seat Height:
20½ -26½"H

**B Medical Stool w/Polished Chrome Base
343FPA**

Overall: 25"Dia x 20½-26½"H
Seat: 16"Dia x 20½-26½"H
List: \$371.00

Functions: Adjustable Seat Height, 360 Degree Swivel



Seat Height:
20½ -26½"H



Seat Height
w/Footing:
28 -34"H

Shown w/Optional Footring

OPTIONAL FOOTRING
(For 343FPA & 345FPA)
Chrome Footring Kit FRKIT
List: \$119.00



BK Black
Antimicrobial Vinyl

Note: 345FP & 343FP can be shipped by a small package carrier.

BELL

**A 29½"H Stool w/Silver Metal Footring Base
398S**

Overall: 24½"W x 24½"D x 29½"H
Seat: 14¼"W x 14¼"D x 29½"H
List: \$223.00

**B 25¼"H Stool w/Silver Metal Footring Base
396S**

Overall: 24"W x 24"D x 25¼"H
Seat: 14¼"W x 14¼"D x 25¼"H
List: \$209.00

Note: 398S, 396S & 2700CASTERS can be shipped by a small package carrier.



OPTIONAL CASTERS
(For 398S & 396S)
Casters (Set of 4) 2700CASTERS
List: \$58.00
(BK Black)



BK Black Plastic Seat



NEW! ORION

Pictured w/NEW! American Elm Finish & NEW! OSTYP321 Typical

A Mesh Back Task Chair

w/Black Frame
OSTW8001

Overall: 23 $\frac{1}{16}$ "W x 26"D x 37 $\frac{13}{16}$ "H
Seat: 20 $\frac{1}{16}$ "W x 17 $\frac{1}{2}$ "D x 16 $\frac{1}{16}$ -23 $\frac{11}{16}$ "H
List: \$516.00

Functions: Adjustable Seat Height,
360 Degree Swivel, Tilt-Tension, Height
Adjustable Arms

B Mesh Back Managers Chair

w/Black Frame
OSTW8002

Overall: 23 $\frac{1}{16}$ "W x 26"D x 37 $\frac{13}{16}$ "H
Seat: 20 $\frac{1}{16}$ "W x 18 $\frac{1}{8}$ -19 $\frac{3}{4}$ "D x 16 $\frac{1}{16}$ -23 $\frac{11}{16}$ "H
List: \$680.00

Functions: Adjustable Seat Height, Seat Slider,
360 Degree Swivel, Synchro-Tilt, Self-Adjusting
Tilt, Tilt-Lock, Multi-Position Back Lock, Height
Adjustable Arms

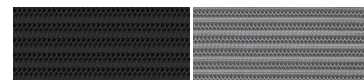

BK Black Mesh
w/Mesh
(OSTW8001
& OSTW8002)

PW Pewter Mesh
w/Mesh
(OSTW8002 Only)



A



B

CHAIR FEATURES



Managers chair has a synchro-tilt mechanism and seat slider



Both chairs have lumbar support and premium nylon mesh back and seat



NEW! ORION

Pictured w/PL236 Conference Table & OS Laminate Storage (2) PL113, PL110 & PL207

C Mesh Conference Chair w/Black Frame

OSTW8003

Overall: 22¹/₁₆"W x 22¹/₂"D x 34¹/₂"H

Seat: 22³/₄"W x 17¹/₂"D x 17⁵/₁₆-27¹/₂"H

List: \$476.00

Functions: Adjustable Seat Height, 360 Degree Swivel, Tilt-Tension

FEATURES

- Premium mesh back promotes air circulation
- Unique chair shape is designed for support and optimal comfort during long meeting hours
- Complements well with Orion task and manager chairs
- Perfect for your meeting or training rooms

Matching Orion Conference Chair



CHAIR FEATURES



Fixed loop arms with a modern design



Spring tilt mechanism with tilt tension control for optimal productivity during long hours



BK Black Mesh w/Mesh (OSTW8003 Only)



OSLO

Pictured w/PL437 Conference Table

A Mid Back Mesh Task Chair w/Adj. Arms & Black Frame 600MMFBK

Overall: 25"W x 22-24"D x 37-40¾"H
Seat: 18½"W x 19"D x 18-21¾"H
List: \$770.00

Functions: Adjustable Seat Height, Seat Slider, 360 Degree Swivel, Adjustable Lumbar Support, Tilt-Tension, Synchro-Tilt, Tilt-Lock, Multi-Position Back Lock, Height Adjustable Arms

B Mid Back Mesh Task Chair w/Adj. Arms & Light Gray Frame 601MMFGT

Overall: 25"W x 22-24"D x 37-40¾"H
Seat: 18½"W x 19"D x 18-21¾"H
List: \$770.00

Functions: Adjustable Seat Height, Seat Slider, 360 Degree Swivel, Adjustable Lumbar Support, Tilt-Tension, Synchro-Tilt, Tilt-Lock, Multi-Position Back Lock, Height Adjustable Arms

600MMFBK Only

601MMFGT Only

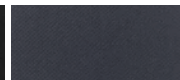

Black Fabric
w/Black Mesh Back

Dark Gray Fabric
w/Light Gray Mesh Back



CHAIR FEATURES



Nylon mesh backrest
promotes air circulation



Synchro-tilt mechanism
and seat slider with height
adjustable armrests

Note: Oslo task chairs can be shipped by a small package carrier. 📦

OSLO



C Mid Back Mesh Conference Chair w/Black Frame & Fixed Arms 602MMFBK

Overall: 23½"W x 22-24"D x 37-40¾"H
 Seat: 18½"W x 19"D x 18-21¾"H
 List: \$770.00

Functions: Adjustable Seat Height, Seat Slider, 360 Degree Swivel, Adjustable Lumbar Support, Tilt-Tension, Synchro-Tilt, Tilt-Lock, Multi-Position Back Lock



D Mid Back Mesh Conference Chair w/Light Gray Frame & Fixed Arms 603MMFGT

Overall: 23½"W x 22-24"D x 37-40¾"H
 Seat: 18½"W x 19"D x 18-21¾"H
 List: \$770.00

Functions: Adjustable Seat Height, Seat Slider, 360 Degree Swivel, Adjustable Lumbar Support, Tilt-Tension, Synchro-Tilt, Tilt-Lock, Multi-Position Back Lock



Lumbar Support for All Day Comfort

602MMFBK, 604MMFBK & 606MMFBK Only

603MMFGT & 605MMFGT Only



Black Fabric w/Black Mesh Back



Dark Gray Fabric w/Light Gray Mesh Back

Note: Oslo chairs can be shipped by a small package carrier. 📦



E Mesh Back Stacking Guest Chair w/Black Frame 604MMFBK

Overall: 24"W x 22¼"D x 33½"H
 Seat: 19¾"W x 17¾"D x 18¾"H
 List: \$530.00



F Mesh Back Stacking Guest Chair w/Light Gray Frame 605MMFGT

Overall: 24"W x 22¼"D x 33½"H
 Seat: 19¾"W x 17¾"D x 18¾"H
 List: \$530.00



G NEW! Mesh Back Armless, Stacking Guest Chair w/Black Frame 606MMFBK

Overall: 22½"W x 19½"D x 33½"H
 Seat: 19¾"W x 17¾"D x 18¾"H
 List: \$380.00

Waterfall Front Edge Seat

STACKS HIGH
 4
 With Casters



Stacks 4 High (With or Without Casters)

Casters Included With Chair For Both Black & Gray Options - Stacking & Armless Stacking



INTERCHANGEABLE

Pictured w/NEW! American Elm Finish & NEW! Interchangeable Guest Chairs

A Gray Or Black Mesh Back, Task Chair w/Black Seat & Black Base

656MGF (w/Gray Mesh Back)

656MBF (w/Black Mesh Back)

Overall: 26½"W x 25½"D x 39-42"H

Seat: 19"W x 19"D x 18½-21½"H

List: \$602.00

Functions: Adjustable Seat Height, 360 Degree Swivel, Adjustable Lumbar Support, Tilt-Tension, Synchro-Tilt, Tilt-Lock, Height Adjustable Arms

B Optional Interchangeable Seat Cover

656COVERF (Fabric)

656COVERA (Antimicrobial Vinyl)

Fabric Cover List: \$30.00

Antimicrobial Vinyl Cover List: \$30.00

Gray Mesh Back Option
w/Optional Interchangeable Seat Cover in Steel Blue



Optional Fabric Seat Cover Options



Black Mesh Back Option
w/Black Fabric Seat

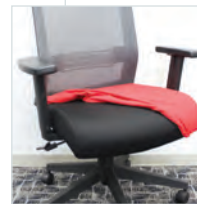

UNIQUE FEATURES

Change the seat color easily or remove it for cleaning. This chair allows you to do both or either

Note: This collection can be shipped by a small package carrier. 📦

Optional Vinyl Seat Cover Options

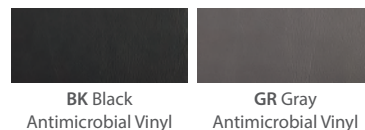



NEW! INTERCHANGEABLE

Pictured w/NEW! Interchangeable Task Chair & PL437 Conference Table

C Black Mesh, High Back Task Chair w/Aluminum Arms & Base 6566AL

Overall: 26⁷/₈"W x 24¹³/₁₆"D x 42³/₄"H
 Seat: 19"W x 19"D x 19-22"H
 List: \$940.00

Functions: Adjustable Seat Height, 360 Degree Swivel, Adjustable Lumbar Support, Tilt-Tension, Synchro-Tilt, Tilt-Lock

D Gray or Black Mesh Back, Armless Guest Chair w/Sled Base

6569MGF (Gray Mesh Back)
6569MBF (Black Mesh Back)
 Overall: 25¹/₆"W x 19¹/₂"D x 39⁵/₈"H
 Seat: 19⁷/₁₆"W x 19⁷/₁₆"D x 18³/₄"H
 List: \$610.00

CHAIR FEATURES



Adjustable lumbar support for optimal comfort all day long



Synchro-tilt with tension and lock mechanisms

MATCHING GUEST CHAIR

See Page 151



Padded Armrests



Fixed Aluminum Arms For A Sleek Look

Optional Fabric Seat Cover Options



Optional Vinyl Seat Cover Options

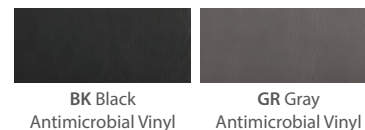



PALMA

A High Back, Ribbed Mesh Task Chair & Headrest w/Black Frame 200HMFBK

Overall: 25 $\frac{5}{8}$ "W x 22 $\frac{1}{5}$ "D x 46 $\frac{5}{16}$ "-49 $\frac{3}{16}$ "H

Seat: 19 $\frac{5}{16}$ "W x 17 $\frac{3}{8}$ "-19 $\frac{5}{16}$ "D x 17 $\frac{1}{8}$ "-20 $\frac{1}{16}$ "H

List: \$1,116.00

Functions: Adjustable Seat Height, Seat Slider, 360 Degree Swivel, Adjustable Lumbar Support, Tilt-Tension, Synchro-Tilt, Tilt Lock, Height & Width Adjustable Arms

B High Back, Ribbed Mesh Task Chair & Headrest w/Light Gray Frame 201HMFGT

Overall: 25 $\frac{5}{8}$ "W x 22 $\frac{1}{5}$ "D x 46 $\frac{5}{16}$ "-49 $\frac{3}{16}$ "H

Seat: 19 $\frac{5}{16}$ "W x 17 $\frac{3}{8}$ "-19 $\frac{5}{16}$ "D x 17 $\frac{1}{8}$ "-20 $\frac{1}{16}$ "H

List: \$1,116.00

Functions: Adjustable Seat Height, Seat Slider, 360 Degree Swivel, Adjustable Lumbar Support, Tilt-Tension, Synchro-Tilt, Tilt Lock, Height & Width Adjustable Arms

FEATURES

- Includes height adjustable headrest that can be removed from chair if not needed
- Chair features 3D armrest, 3-Locking mechanism, seat slider and tension control functions

Note: Palma task chairs can be shipped by a small package carrier. 📦



BK Black Fabric w/Black Mesh



GT Light Gray Fabric w/Light Gray Mesh

ENGAGE



Mesh, Mid Back Task Chair w/Chrome Base 18921M

Overall: 25"W x 23⁵/₈"D x 40³/₈-43⁷/₈"H
Seat: 20"W x 24¹/₂"D x 19⁷/₈-23¹/₂"H
List: \$1,423.00

Functions: Adjustable Seat Height, Seat Slider, 360 Degree Swivel, Tilt-Tension, Tilt-Lock, Multi-Position Back Lock, Height Adjustable Arms



BK Black Mesh

CHAIR DESIGN

Passively supports your lumbar curve with a unique back design



Note: Engage can be shipped by a small package carrier. 📦



COSTA



Task Chair w/Black Frame C12MBFSM

Overall: 25¹/₂"W x 25¹/₄"D x 39³/₄-43"H
Seat: 20¹/₂"W x 20¹/₂"D x 18¹/₂-21³/₄"H
List: \$669.00

Functions: Adjustable Seat Height, 360 Degree Swivel, Tilt-Tension, Knee-Tilt, Independent Back Angle, Height Adjustable Arms



BK Black Mesh

CHAIR DESIGN

Features seven ergonomic adjustments including adjustable arms



Note: Costa can be shipped by a small package carrier. 📦





COOLMESH PRO

Pictured w/Variant - NEW! OSTYP301 Typical

FEATURES

- Hard, ratchet back provides support and durability
- Multi-functional chair offering many features and functions
- Choose between six fabric seat options, vinyl, leather or mesh
- Optional soft dual wheel casters and titanium base available

Cool Mesh Pro Multi-Function, High Back w/Black Base & Adj. Arms

Overall: 27½"W x 26⅜"D x 40⅙-44½"H

Seat: 20½"W x 19½"D x 19⅝-22⅞"H

8014ASNSF (Fabric Seats) List: \$1,037.00

8014ASNSA (AM Vinyl & Fabric Seats) List: \$1,037.00

8014ASNSM (Mesh Seat) List: \$1,114.00

8014ASNSL (Leather Seat) List: \$1,136.00

Functions: Adjustable Seat Height, Ratchet Back, Seat Slider, 360 Degree Swivel, Tilt-Tension, Tilt-Lock, Forward Seat-Tilt, Independent Back Angle, Multi-Position Back Lock, Height & Width Adjustable Arms



CHAIR FEATURE

Chair provides lumbar support with curved back design

Note: 8014ASNS, 7000HR, & CASTERSPU can be shipped by a small package carrier.



Pictured w/Leather Seat

OPTIONAL HEADREST

(For 8014ASNS)

Headrest 7000HR

List: \$105.00
(BK Black)



OPTIONAL CASTERS

(For 8014ASNS)

Soft Dual Wheel (Set of 5)

CASTERSPU
List: \$55.00
(BK Black)



OPTIONAL BASE

(For 8014ASNS)

Titanium Base ABASET

List: \$205.00



OfficeSource® CoolMesh Pro Seat Type Options - Build Your Custom Chair



BK Black Fabric

NV Navy Blue Fabric

BL Celestial Blue Fabric

GR Cool Gray Fabric

AS Ash Gray

BK Black
Antimicrobial PU Leather

BK Top Grain
Leather



RD Red Fabric



OR Orange Fabric



CO Cobalt Blue
Antimicrobial Fabric



OL Olive Green
Antimicrobial Fabric

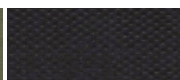

BK Mesh



NP Neptune
Antimicrobial PU Leather

Note: When selecting chair, please choose seat cushion.



COOLMESH PRO

Pictured w/OS Training Tables - NEW! OSTYP326 Typical

Nesting Chair w/Titanium Gray Frame

Overall: 24"W x 24¾"D x 38"H

Seat: 18½"W x 19¼"D x 18⅝"H

8094TNSF (Fabric) List: \$652.00

8094TNSA (Vinyl) List: \$691.00

FEATURES

- Hard, ratchet back provides support and durability
- Stylish mesh back has nesting capability and its soft seating will impress any guest
- Choose between four fabric seat options or black antimicrobial vinyl; matching task chair available
- Optional chair glides available in a set of four



*Pictured
w/Fabric Seat*



*Pictured
w/Vinyl Seat*

OPTIONAL GLIDES

(For 8094TNS)

Glides (Set of 4)

2700GLIDES

List: \$53.00

(BK Black)



Nesting



Profile View



BK Black Fabric

NV Navy Blue Fabric

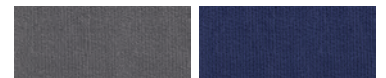

GR Cool Gray Fabric

BL Celestial Blue Fabric



BK Black Antimicrobial
PU Leather

Note: 8094TNS & 2700GLIDES can be shipped by a small package carrier. 📦



COOLMESH

Pictured w/Variant

FEATURES

- Ergonomically designed mesh back provides constant firmness and hugs the natural curve of the back
- Height and width adjustable arms with "ever soft" arm rest padding
- Choose between six fabric seat options, vinyl, leather or mesh
- Optional soft dual wheel casters and titanium base available

Cool Mesh Multi-Function, High Back w/Seat Slider Standard Black Base, Black Mesh Back & Adj. Arms

Overall: 25½"W x 26"D x 40½-44"H

Seat: 20½"W x 19½"D x 17½-21"H

7704ASNSF (Fabric Seats) List: \$963.00

7704ASNSA (AM Vinyl & Fabric Seats) List: \$963.00

7704ASNSM (Mesh Seat) List: \$1,040.00

7704ASNSL (Leather Seat) List: \$1,062.00

Functions: Adjustable Seat Height, Seat Slider, 360 Degree Swivel, Tilt-Tension, Tilt-Lock, Forward Seat-Tilt, Independent Back Angle, Multi-Position Back Lock, Height & Width Adjustable Arms

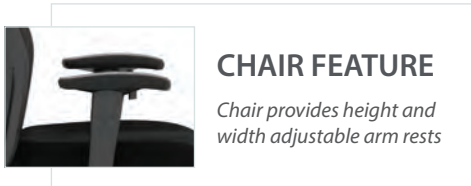

CHAIR FEATURE

Chair provides height and width adjustable arm rests

Note: 7704ASNS, 7000HR, & CASTERSPU can be shipped by a small package carrier. 



Pictured w/Antimicrobial Fabric Seat

OPTIONAL HEADREST

(For 7704ASNS, 7701ASNS & 7754ASNS)

Headrest 7000HR

List: \$105.00
(BK Black)



OPTIONAL CASTERS

(For 7704ASNS, 7701ASNS & 7754ASNS)

Soft Dual Wheel (Set of 5)

CASTERSPU
List: \$55.00
(BK Black)



OPTIONAL BASE

(For 7704ASNS, 7701ASNS & 7754ASNS)

Titanium Base ABASET

List: \$205.00



OfficeSource® CoolMesh Seat Type Options - Build Your Custom Chair



BK Black Fabric

NV Navy Blue Fabric

BL Celestial Blue Fabric

GR Cool Gray Fabric

AS Ash Gray
Antimicrobial Fabric

BK Black
Antimicrobial PU Leather

BK Top Grain
Leather



RD Red Fabric



OR Orange Fabric



CO Cobalt Blue
Antimicrobial Fabric



OL Olive Green
Antimicrobial Fabric

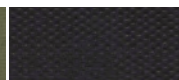

BK Mesh



NP Neptune
Antimicrobial PU Leather

Note: When selecting chair, please choose seat cushion.

COOLMESH



Pictured w/Antimicrobial Fabric Seat



Pictured w/Vinyl Seat

Cool Mesh Synchro, High Back w/Seat Slider & Black Frame

Overall: 26¾"W x 25"D x 41¼-45"H
 Seat: 20½"W x 19½"D x 17¾-21¼"H
7701ASNSF (Fabric Seats) List: \$878.00
7701ASNSA (AM Vinyl & Fabric Seats) List: \$878.00
7701ASNSM (Mesh Seat) List: \$955.00
7701ASNSL (Leather Seat) List: \$977.00

Functions: Adjustable Seat Height, Seat Slider, 360 Degree Swivel, Tilt-Tension, Tilt-Lock, Height & Width Adjustable Arms

Nesting Chair w/Titanium Gray Frame

Overall: 24"W x 24"D x 37"H
 Seat: 18½"W x 19"D x 19¼"H
7794TNSF (Fabric Seats) List: \$608.00
7794TNSA (Vinyl Seats) List: \$647.00

Nesting Armless Chair w/Titanium Gray Frame

Overall: 22"W x 24"D x 37"H
 Seat: 18½"W x 19"D x 19¼"H
7774TNSF (Fabric Seats) List: \$593.00
7774TNSA (Vinyl Seats) List: \$632.00

Note: 7794TNS & 7774TNS Available in Black (BK), Navy Blue (NV), Celestial Blue (BL), Cool Gray (GR) or Black Antimicrobial PU Leather (BK) Only.



7794TNS - Pictured w/Vinyl Seat



7774TNS - Pictured w/Fabric Seat

OPTIONAL GLIDES
 (For 7794TNS & 7774TNS)
Glides (Set of 4)
2700GLIDES
 List: \$53.00
 (BK Black)

Cool Mesh Multi-Function, Mid Back w/Seat Slider & Black Frame

Overall: 26½"W x 27¼"D x 36-39½"H
 Seat: 20½"W x 19½"D x 18½-22"H
7754ASNSF (Fabric Seats) List: \$895.00
7754ASNSA (AM Vinyl & Fabric Seats) List: \$895.00
7754ASNSM (Mesh Seat) List: \$972.00
7754ASNSL (Leather Seat) List: \$994.00

Functions: Adjustable Seat Height, Seat Slider, 360 Degree Swivel, Tilt-Tension, Tilt-Lock, Forward Seat-Tilt, Independent Back Angle, Multi-Position Back Lock, Height & Width Adjustable Arms

Note: All items on this page can be shipped by a small package carrier.



Pictured w/Mesh Seat

OfficeSource® CoolMesh Seat Type Options - Build Your Custom Chair

BK Black Fabric	NV Navy Blue Fabric	BL Celestial Blue Fabric	GR Cool Gray Fabric	AS Ash Gray Antimicrobial Fabric	BK Black Antimicrobial PU Leather	BK Top Grain Leather
RD Red Fabric	OR Orange Fabric	CO Cobalt Blue Antimicrobial Fabric	OL Olive Green Antimicrobial Fabric	BK Mesh	NP Neptune Antimicrobial PU Leather	

Note: When selecting chair, please choose seat cushion.



COOLMESH

Pictured w/OS Laminate & Dover Seating - OS266 Typical

Cool Mesh Swivel Tilt, High Back Task Chair w/Arms & Black Frame

Overall: 26¾"W x 25¼"D x 41½-44¾"H

Seat: 20½"W x 19½"D x 17¾-21¼"H

7721ANSF (Fabric Seats) List: \$776.00

7721ANSA (AM Vinyl & Fabric Seats) List: \$776.00

7721ANSM (Mesh Seat) List: \$853.00

7721ANSL (Leather Seat) List: \$875.00

Functions: Adjustable Seat Height, 360 Degree Swivel, Tilt-Tension, Tilt-Lock, Height & Width Adjustable Arms

OPTIONAL BASE

(For 7721ANS & 7621ANS)

Titanium Base ABASET

List: \$205.00



OPTIONAL CASTERS

(For 7721ANS & 7621ANS)

Soft Dual Wheel (Set of 5)

CASTERSPU

List: \$55.00

(BK Black)



Note: 7721ANS & CASTERSPU can be shipped by a small package carrier. 📦

COOLMESH BASIC



Cool Mesh Basic Task Chair w/Arms & Black Frame

Overall: 26½"W x 25¼"D x 36-40"H

Seat: 20½"W x 19½"D x 18-21¾"H

7621ANSF (Fabric Seats) List: \$662.00

7621ANSA (AM Vinyl & Fabric Seats) List: \$662.00

7621ANSM (Mesh Seat) List: \$739.00

7621ANSL (Leather Seat) List: \$761.00

Functions: Adjustable Seat Height, Ratchet Back, 360 Degree Swivel, Tilt-Tension, Tilt-Lock, Height & Width Adjustable Arms

Note: 7621ANS can be shipped by a small package carrier. 📦



Pictured w/OS Laminate

OfficeSource® CoolMesh & Basic Seat Type Options - Build Your Custom Chair



BK Black Fabric

NV Navy Blue Fabric

BL Celestial Blue Fabric

GR Cool Gray Fabric

AS Ash Gray

BK Black

BK Top Grain

Antimicrobial Fabric

Antimicrobial PU Leather

Leather



RD Red Fabric



OR Orange Fabric

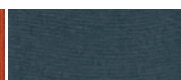

CO Cobalt Blue

Antimicrobial Fabric



OL Olive Green

Antimicrobial Fabric

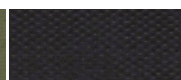

BK Mesh



NP Neptune

Antimicrobial PU Leather

Note: When selecting chair, please choose seat cushion.



COOLMESH

Pictured w/OS Training Tables - OST07 Typical

A Mesh Back Guest Chair w/Arms & Titanium Gray Frame

Overall: 25"W x 24"D x 36"H

Seat: 18"W x 19"D x 18"H

7804TGNSF (Fabric) List: \$516.00

7804TGNSA (Vinyl) List: \$547.00

B Mesh Back Guest Chair w/Arms & Black Frame

Overall: 25¼"W x 24⅞"D x 37"H

Seat: 18½"W x 18½"D x 19"H

7944GNSF (Fabric) List: \$569.00

7944GNSA (Vinyl) List: \$599.00

Note: CoolMesh chairs can be shipped by a small package carrier. 📦

**OPTIONAL
CASTERS**
(For 7804TGNS & 7944GNS)
Casters (Set of 4)
2700CASTERS
List: \$58.00
(BK Black)

**STACKS
4
H
I
G
H**
Without Casters

**STACKS
5
H
I
G
H**
Without Casters



Shown w/Optional Casters



BK Black Fabric

NV Navy Blue Fabric

BL Celestial
Blue Fabric
(7944GNS Only)

GR Cool Gray Fabric

BK Black Antimicrobial
PU Leather



ADVANCED

Pictured w/OS Laminate - OS127 Typical

A Multi-Function High Back Task Chair w/Adj. Arms & Black Base 8456ASF

Overall: 27 $\frac{1}{4}$ "W x 25 $\frac{1}{2}$ "D x 41-44 $\frac{1}{2}$ "H
Seat: 21"W x 19"D x 18-22"H
List: \$932.00

Functions: Adjustable Seat Height, Seat Slider, 360 Degree Swivel, Tilt-Tension, Tilt-Lock, Forward Seat-Tilt, Multi-Position Back Lock, Height & Width Adjustable Arms

B Guest Chair w/Arms & Titanium Gray Frame 2904TGF

Overall: 25 $\frac{5}{8}$ "W x 24"D x 32 $\frac{1}{16}$ "H
Seat: 18 $\frac{1}{2}$ "W x 19"D x 18"H
List: \$462.00



BK Black Fabric

Note: Advanced can be shipped by a small package carrier.



Stacking

OPTIONAL CASTERS (For 2904TGF)

Casters (Set of 4)
2700CASTERS

List: \$58.00
(BK Black)



SPICE



Mid Back Task Chair, Mesh Back w/Black Frame

Overall: 26½"W x 25"D x 36¾-40¼"H
 Seat: 20"W x 19"D x 17¾-21¼"H
7854ANSF (Fabric Seats) List: \$704.00
7854ANSA (AM Vinyl & Fabric Seats) List: \$704.00
7854ANSL (Leather Seat) List: \$803.00

Functions: Adjustable Seat Height, 360 Degree Swivel, Tilt-Tension, Tilt-Lock, Height & Width Adjustable Arms

This product is part of a complete collection. See Page 170

Note: Spice can be shipped by a small package carrier.



UNIQUE FEATURES
Ergonomic and comfortable chair with height and width adjustable arms fit for any office setting

OfficeSource® Spice Seat Type Options - Build Your Custom Chair

						
BK Black Fabric	NV Navy Blue Fabric	BL Celestial Blue Fabric	GR Cool Gray Fabric	AS Ash Gray Antimicrobial Fabric	BK Black Antimicrobial PU Leather	BK Top Grain Leather
						
RD Red Fabric	OR Orange Fabric	CO Cobalt Blue Antimicrobial Fabric	OL Olive Green Antimicrobial Fabric	BK Mesh	NP Neptune Antimicrobial PU Leather	

Note: When selecting chair, please choose seat cushion.

CRUSADER



Mesh Back, Basic Task Chair w/Arms & Black Frame 7621AAF

Overall: 26½"W x 25¼"D x 36-40"H
 Seat: 20½"W x 19½"D x 18-21¾"H
 List: \$601.00

Functions: Adjustable Seat Height, 360 Degree Swivel, Tilt-Tension, Tilt-Lock, Height & Width Adjustable Arms



BK Black Fabric w/Mesh Back

Note: Crusader can be shipped by a small package carrier.

CHAIR DESIGN
Height and width adjustable arms with soft, padded armrests



Pictured w/OS Laminate - OSB21 Typical



CADE

Pictured w/OS Laminate - OS244 Typical

A

A Executive Mesh Back Chair w/Black Frame

44021BK

Overall: 24"W x 22½"D x 38-43"H

Seat: 19½"W x 19"D x 18-23"H

List: \$685.00

Functions: Adjustable Seat Height,
360 Degree Swivel, Tilt-Tension,
Tilt-Lock, Height Adjustable Arms



CHAIR DESIGN

Chair features height adjustable arm and various other chair functions that promote comfort



BK Black Fabric
w/Mesh

Note: Cade can be shipped by a small package carrier. 📦

ARTESA



Basic Mesh Task Chair w/Painted Metallic Nylon Base & Arms

11501F

Overall: 25¾"W x 23½"D x 36¾-40¾"H

Seat: 20"W x 19½"D x 17¾-21½"H

List: \$716.00

Functions: Adjustable Seat Height, Ratchet
Back, Seat Depth Adjustment, 360 Degree
Swivel, Adjustable Lumbar Support, Tilt-
Tension, Height Adjustable Arms



BK Black Airmesh Seat

CHAIR DESIGN

Adjustable lumbar with
a hard, plastic back for
optimal support



Note: Artesa can be shipped by a small package carrier. 📦



CROSSWAY

Pictured w/OS Laminate Standing Desks

A Mesh Back Task Chair w/Black Base 610F

Overall: 25"W x 26½"D x 36½-40"H
 Seat: 19"W x 17½"D x 18-21½"H
 List: \$356.00

Functions: Adjustable Seat Height,
 360 Degree Swivel, Tilt-Tension, Tilt-Lock,
 Fixed Arms

B Mesh Back Guest Chair w/Arms & Black Frame

Overall: 24"W x 24"D x 33"H
 Seat: 18"W x 18"D x 19½"H
2029F (Fabric Seat) List: \$285.00
2029V (Vinyl Seat) List: \$290.00

C Mesh Back Armless Guest Chair w/Black Frame

Overall: 24"W x 24"D x 33"H
 Seat: 18"W x 18"D x 19½"H
2028F (Fabric Seat) List: \$270.00
2028V (Vinyl Seat) List: \$275.00

Note: All items on this page can be shipped by a small package carrier. 📦



A



B

STACKS
 4 HIGH



C



BK Black Fabric
 w/Mesh Back



BK Black
 Leather Soft Vinyl
 (2029V & 2028V Only)



FRANKLIN

Pictured w/Variant - NEW! OSTYP303 Typical

A Mesh Swivel Chair w/Black Frame & Base

21621M

Overall: 23¾"W x 20"D x 35¾-39¾"H

Seat: 19½"W x 18"D x 17¾-21¾"H

List: \$774.00

Functions: Adjustable Seat Height, 360 Degree Swivel

B Mesh Guest Chair w/Black Sled Base

21628M

Overall: 22½"W x 19¾"D x 36¼"H

Seat: 19½"W x 18"D x 17¾"H

List: \$774.00

CHAIR FEATURES

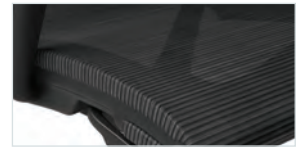

All mesh upholstery for both chairs allows heightened ventilation and breath-ability



Single-piece back and seat are contoured for ergonomic support with fixed loop arms



BK Black Mesh



SI Silver Mesh

Note: Franklin can be shipped by a small package carrier. 📦



FRANKLIN

Pictured w/Sienna Conference Table - See Page 19



Pictured w/OS Training Tables - OST20 Typical



Pictured w/Variant - NEW! OSTYP325 Typical



BK Black Mesh



SI Silver Mesh

Note: Franklin can be shipped by a small package carrier. 📦



Pictured w/OS Laminate - OS235 Typical

PLEXUS

Mesh Back Task Chair w/Arms & Black Base P11MBFSF

Overall: 25"W x 24½"D x 37-41"H

Seat: 20½"W x 20"D x 18-22"H

List: \$461.00

Functions: Adjustable Seat Height, 360 Degree Swivel, Tilt-Tension, Tilt-Lock



BK Black Fabric
w/Mesh Back

CHAIR DESIGN

*Curved back design
provides optimal comfort
and support*

Note: Plexus chair can be shipped by a small package carrier. 📦



SERENE



A

A Flip Arm Mesh Back Task Chair w/Black Frame S13MBVSV

Overall: 25½"W x 26¼"D x 37-41"H

Seat: 20½"W x 20"D x 17¼-21¼"H

List: \$537.00

Functions: Adjustable Seat Height, 360 Degree Swivel, Tilt-Tension, Tilt-Lock, Flip-up Arms



BK Black Vinyl
w/Mesh Back

B Flip Arm Mesh Back Task Chair w/Black Frame 678F

Overall: 27"W x 27"D x 41-44"H

Seat: 20"W x 20½"D x 18-21"H

List: \$603.00

Functions: Adjustable Seat Height, 360 Degree Swivel, Adjustable Lumbar Support, Tilt-Tension, Tilt-Lock, Flip-up Arms



BK Black Fabric
w/Mesh Back

Note: Serene & Pennington chairs can be shipped by a small package carrier. 📦



SERENE + PENNINGTON

Both chairs have a flip-up armrest design

PENNINGTON



B

PENNINGTON CHAIR

Task chair includes a 4" thick seat cushion and adjustable lumbar support



Pictured w/OS Conference Table

EMPIRE

A Executive, Leather High Back w/Chrome Frame 01CU2AHACL

Overall: 29"W x 29½"D x 47¼-50¾"H
Seat: 21"W x 17½"D x 18¼-21"H
List: \$1,462.00

Functions: Adjustable Seat Height, 360 Degree Swivel, Tilt-Tension, Weight-Activated Recline

B Executive, Leather Mid Back w/Chrome Frame 01CU2AMACL

Overall: 28¾"W x 28"D x 38½-41¾"H
Seat: 21"W x 17½"D x 17-19¾"H
List: \$1,252.00

Functions: Adjustable Seat Height, 360 Degree Swivel, Tilt-Tension, Weight-Activated Recline, Tilt-Lock



CHAIR DESIGN

Exclusive weight activated chair mechanism and various other chair functions



BK Black Top Grain Leather



A



A

Sleek & Contemporary Profile



B



VENETO

Pictured w/OS Laminate - OS19V Typical

A Executive High Back Chair w/Polished Aluminum Frame 300HL

Overall: 23⁷/₈"W x 23⁷/₁₆-25"D x 40⁹/₁₆-43¹/₈"H

Seat: 20⁸/₈"W x 17³/₄-19⁵/₁₆"D x 17³/₈-19¹/₁₆"H

List: \$2,595.00

Functions: Adjustable Seat Height, Seat Slider, 360 Degree Swivel, Tilt-Tension, Synchro-Tilt, Tilt-Lock

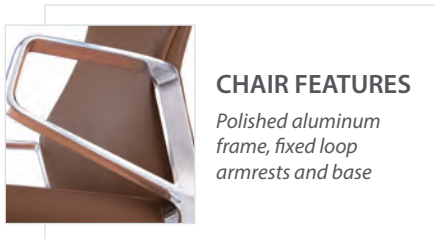

CHAIR FEATURES

Polished aluminum frame, fixed loop armrests and base

Note: Veneto chairs can be shipped by a small package carrier. 📦



CA Caramel
Microfiber Leather



GR Gray
Microfiber Leather



NEW! BK Black
Microfiber Leather



B

VENETO

Pictured w/OS Conference Table in NEW! American Elm Finish

FEATURES

- High and Mid Back chairs have a 3-locking mechanism, seat slider, tension control and additional chair functions for the busy executive
- Choose between three modern upholstery colors: Caramel, Gray or NEW! Black Microfiber Leather



CHAIR FEATURES

Discreet under-seat controls with 3-position locking recline and seat slider for functionality



B

B Executive Mid Back Chair w/Polished Aluminum Frame 301ML

Overall: 23⁷/₁₆"W x 23⁷/₁₆"-25"D x 38-40⁵/₁₆"H
 Seat: 20¹/₈"W x 17³/₄"-19⁵/₁₆"D x 17³/₈"-19¹⁵/₁₆"H
 List: \$2,395.00

Functions: Adjustable Seat Height, Seat Slider, 360 Degree Swivel, Tilt-Tension, Synchro-Tilt, Tilt-Lock

Note: Veneto chairs can be shipped by a small package carrier. 



BRADLEY

Pictured w/OS Conference Table - PLELP236 Typical

Executive High Back w/Chrome Frame & Base 74011A

Overall: 27¼"W x 31"D x 46¾"-50"H
 Seat: 20½"W x 20¾"D x 17¾"-20½"H
 List: \$1,324.00

Functions: Adjustable Seat Height, 360 Degree Swivel, Adjustable Lumbar Support, Tilt-Tension, Tilt-Lock



BK Black
 Antimicrobial
 PU Leather

GR Light Gray
 Antimicrobial
 PU Leather

CHAIR DESIGN

Chair comes with a adjustable lumbar support and built-in padded headrest for optimal comfort while sitting



Note: Bradley can be shipped by a small package carrier. 

PRESTIGE



A



B

Note: Prestige can be shipped by a small package carrier. 📦

A Executive High Back w/Chrome Frame & Base 7765V

Overall: 27"W x 29½"D x 45-48"H
Seat: 20"W x 20"D x 19-22"H
List: \$1,062.00

Functions: Adjustable Seat Height,
360 Degree Swivel, Tilt-Tension, Tilt-
Lock, Knee-Tilt, Multi-Position Back Lock

B Executive Mid Back w/Chrome Frame & Base 7745V

Overall: 27"W x 28"D x 38-41"H
Seat: 20"W x 20"D x 19-22"H
List: \$980.00

Functions: Adjustable Seat Height,
360 Degree Swivel, Tilt-Tension, Tilt-
Lock, Knee-Tilt, Multi-Position Back Lock



BK Black PU Leather

CHAIR DESIGN

Chair comes with a knee
tilt function and padded
armrests for comfort

ARC



Executive High Back w/Fixed Arms & High Crown Chrome Base 514V

Overall: 25¼"W x 30½"D x 44¼"-47¼"H
Seat: 19¾"W x 21"D x 19¾"-22¾"H
List: \$904.00

Functions: Adjustable Seat Height, 360 Degree
Swivel, Tilt-Tension, Tilt-Lock

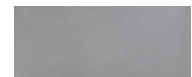

GR Gray PU Leather



BK Black PU Leather

CHAIR DESIGN

Chair comes with a spring
tilt mechanism with
many other functions



Note: Arc can be shipped by a small package carrier. 📦

RIDGE



A Executive High Back, Ribbed Back Task Chair w/Chrome Base 05RG2QHAV

Overall: 29"W x 23½"D x 42-45"H
 Seat: 20½"W x 18"D x 17¼-20¾"H
 List: \$934.00

Functions: Adjustable Seat Height, 360 Degree Swivel, Tilt-Tension, Tilt-Lock



B Executive Mid Back Armless, Ribbed Back Task Chair w/Chrome Base 05RG2WMAV

Overall: 26"W x 23"D x 35½-38½"H
 Seat: 20"W x 18"D x 17-20"H
 List: \$664.00

Functions: Adjustable Seat Height, 360 Degree Swivel, Tilt-Tension, Tilt-Lock



C Guest Chair w/Chrome Sled Base 9509V

Overall: 22¾"W x 24"D x 37"H
 Seat: 20"W x 18"D x 19"H
 List: \$493.00



CHAIR DESIGN

Zippered, removable arm pads that can be replaced or taken off for executive high back chair only



BK Black
 Leather Soft Vinyl



GR Gray
 Leather Soft Vinyl

Note: Ridge chairs can be shipped by a small package carrier.



B

MERAK

Pictured w/NEW! Lucca in Cypress with Pearl White Finish - See Pages 16-17

A Executive High Back w/Chrome Base 1501V

Overall: 27"W x 29"D x 43¼-46¾"H
 Seat: 20¼"W x 21½"D x 20-23"H
 List: \$948.00

Functions: Adjustable Seat Height, 360 Degree Swivel, Tilt-Tension, Tilt-Lock, Multi-Position Back Lock



A

B Executive Mid Back w/Chrome Base 1505V

Overall: 27"W x 27"D x 38-41"H
 Seat: 19"W x 20"D x 20-23"H
 List: \$930.00

Functions: Adjustable Seat Height, 360 Degree Swivel, Tilt-Tension, Tilt-Lock, Multi-Position Back Lock



C

C Sled Base Guest Chair w/Chrome Base 1509V

Overall: 27"W x 27"D x 41"H
 Seat: 19½"W x 21"D x 18½"H
 List: \$884.00

CHAIR DESIGN

All Merak chairs come with a smooth back design complementing its sleek chrome frame

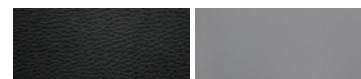

BK Black
PU Leather

GR Gray
PU Leather



WH White
PU Leather

NEW! CA Caramel
PU Leather

Note: Merak chairs can be shipped by a small package carrier. 



TRE

Pictured w/OS Laminate - OS88 Typical

A Executive High Back w/Chrome Base

50811KTA

Overall: 25¾"W x 25¾"D x 44-47¼"H

Seat: 19¾"W x 19"D x 18¼-21½"H

List: \$1,477.00

Functions: Adjustable Seat Height, 360 Degree Swivel, Tilt-Tension, Tilt-Lock, Knee-Tilt

B Executive Mid Back w/Chrome Base

50821KTA

Overall: 25¾"W x 25¾"D x 37¾-41"H

Seat: 19¾"W x 19"D x 18¼-21½"H

List: \$1,349.00

Functions: Adjustable Seat Height, 360 Degree Swivel, Tilt-Tension, Tilt-Lock, Knee-Tilt



C Executive Guest Sled Base Chair w/Chrome Base

50828A

Overall: 22½"W x 24¾"D x 37¾"H

Seat: 19¾"W x 19"D x 19¼"H

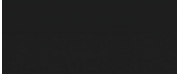
List: \$1,034.00

	
BK Black Antimicrobial PU Leather	GT Light Gray Antimicrobial PU Leather



Note: Tre chairs can be shipped by a small package carrier. 



TRE LITE

Pictured w/OS Conference / Multi-Purpose - NEW! OSTYP313 Typical

A Executive High Back w/Chrome Base

60811A

Overall: 25½"W x 25½"D x 41¾-45"H

Seat: 19¾"W x 19"D x 16¾-20"H

List: \$1,327.00

Functions: Adjustable Seat Height, 360 Degree Swivel, Tilt-Tension, Tilt-Lock

B Executive Mid Back w/Chrome Base

60821A

Overall: 25½"W x 25½"D x 35½-38½"H

Seat: 19¾"W x 19"D x 16¾-20"H

List: \$1,198.00

Functions: Adjustable Seat Height, 360 Degree Swivel, Tilt-Tension, Tilt-Lock

C Executive Guest Chair w/Chrome Sled Base

50828A

Overall: 22½"W x 24¾"D x 37¾"H

Seat: 19¾"W x 19"D x 19¼"H

List: \$1,034.00



BK Black
Antimicrobial
PU Leather

GT Light Gray
Antimicrobial
PU Leather



Note: Tre Lite chairs can be shipped by a small package carrier. 

BOXERO



Executive High Back w/Chrome Base 1401V

Overall: 23¼"W x 29¼"D x 40¾-43¾"H
Seat: 19¼"W x 19¼"D x 19-22"H
List: \$687.00

*Functions: Adjustable Seat Height,
360 Degree Swivel, Tilt-Tension, Tilt-Lock*



BK Black PU Leather

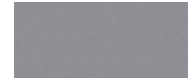

GR Gray PU Leather

CHAIR DESIGN

*Chair comes with a spring
tilt mechanism with
many other functions*



Note: Boxero can be shipped by a small package carrier. 📦

STUDIO



Executive Mid Back Chair w/Chrome Base 696V

Overall: 27"W x 30"D x 40-43"H
Seat: 19¾"W x 19"D x 19-22"H
List: \$621.00

*Functions: Adjustable Seat Height,
360 Degree Swivel, Tilt-Tension, Tilt-Lock*

CHAIR DESIGN

*Easily remove and replace
the arm pads of this chair
with no effort*



Note: Studio can be shipped by a small package carrier. 📦



BK Black PU Leather



GR Gray PU Leather



RD Red PU Leather



WH White PU Leather

OBSIDIAN



A

**A High Back Executive Task Chair w/Adj. Arms & Black Base
05AG2QHEV**

Overall: 27"W x 29"D x 44-47"H
Seat: 20"W x 18½"D x 19½-22½"H
List: \$916.00

Functions: Adjustable Seat Height, 360 Degree Swivel, Tilt-Tension, Tilt-Lock, Independent Back Angle, Multi-Position Back Lock, Height Adjustable Arms



B

**B NEW! High Back Executive Conference Chair w/Fixed Aluminum Arms & Base
OSEC9001**

Overall: 30⅞"W x 26⅜"D x 46⅓"H
Seat: 20½"W x 17⅞"D x 20⅝-23¼"H
List: \$1,200.00

Functions: Adjustable Seat Height, 360 Degree Swivel, Synchro Tilt Mechanism, Self-Adjusting Tilt Recline, Infinite Tilt Lock (Back Cushion)



B



BK Black PU Leather

Note: Obsidian can be shipped by a small package carrier. 📦



CHAIR FEATURES

Discreet recline and lock control levers underneath seat cushion for conference chair



Extra thick, padded seat cushion for optimal long-term comfort throughout your day



Conference chair includes lightly padded, fixed aluminum armrests with an aluminum base



Conference chair includes an all pull lever control system with a synchro tilt mechanism and infinite tilt lock



B

Pictured w/Palissades

LANCASTER



**A High Back Executive Swivel
w/Mahogany Base
378V**

Overall: 27½"W x 30"D x 42-45½"H
Seat: 24"W x 20"D x 20-23½"H
List: \$1,339.00

Functions: Adjustable Seat Height,
360 Degree Swivel, Tilt-Tension, Tilt-Lock



**B High Back Executive Swivel
w/Mahogany Frame & Base
294V**

Overall: 27"W x 28"D x 43½-47"H
Seat: 24"W x 19"D x 19½-23"H
List: \$1,015.00

Functions: Adjustable Seat Height,
360 Degree Swivel, Tilt-Tension, Tilt-Lock

FEATURES

- Blend of traditional & contemporary design
- Mahogany wood finish frame



**C Guest Chair w/Mahogany Frame
291V**

Overall: 24½"W x 27"D x 35½"H
Seat: 20"W x 19"D x 18"H
List: \$818.00



**D Guest Chair
w/Mahogany Frame
271V**

Overall: 24"W x 26"D x 31"H
Seat: 22"W x 21"D x 18½"H
List: \$538.00



**E Guest Chair w/Mahogany
Frame & Casters
272V**

Overall: 24"W x 26"D x 31"H
Seat: 22"W x 21"D x 18½"H
List: \$570.00

GUEST CHAIR FEATURES



Bold, antique brass rivets along
the armrests and bottom of the
seat cushion



Antique brass framework
mounts to the durable casters
for a mobile option



BK Black
Leather Soft Vinyl

Note: 294V, 291V, 271V & 272V on this page  can be shipped by a small package carrier.

CHARLESTON



Executive High Back, Tufted Seat & Back w/Mahogany Arms & Base 20271A

Overall: 28½"W x 32"D x 47-49¾"H
 Seat: 23"W x 18½"D x 20½-23¼"H
 List: \$1,561.00

Functions: Adjustable Seat Height, 360 Degree Swivel, Tilt-Lock



BK Black
 Antimicrobial
 PU Leather

CHAIR DESIGN

Plastic, wooden base
 and arm material with
 mahogany look



Note: Charleston can be shipped by a small package carrier. 📦

SPENCER

A Executive High Back w/Mahogany Frame & Base 1265V

Overall: 27"W x 28"D x 46-49½"H
 Seat: 21"W x 20½"D x 19-22½"H
 List: \$832.00

Functions: Adjustable Seat Height,
 360 Degree Swivel, Tilt-Tension, Tilt-Lock

B Executive Mid Back w/Mahogany Frame & Base 1245V

Overall: 27"W x 28"D x 37-40"H
 Seat: 21"W x 20½"D x 20-23"H
 List: \$801.00

Functions: Adjustable Seat Height,
 360 Degree Swivel, Tilt-Tension, Tilt-Lock

C Guest Chair w/Mahogany Frame 1240V

Overall: 26"W x 28"D x 36"H
 Seat: 21"W x 20½"D x 19"H
 List: \$669.00



BK Black
 Leather Soft Vinyl

Note: Spencer chairs on this page can be shipped by a small package carrier. 📦



CONTOUR



A Executive High Back w/Black Base 489L

Overall: 24¾"W x 28½"D x 45¼-48¼"H
Seat: 20¼"W x 19"D x 19-22"H
List: \$856.00

Functions: Adjustable Seat Height, 360 Degree Swivel, Tilt-Tension, Tilt-Lock, Knee-Tilt, Multi-Position Back Lock



BK Black
Bonded Leather

CONTOUR CHAIR

Chair comes with a knee tilt function for optimal comfort while sitting

B Executive High Back Chair w/Black Base 70101A

Overall: 25¼"W x 27½"D x 41½-44"H
Seat: 20½"W x 19¾"D x 17½-21"H
List: \$649.00

Functions: Adjustable Seat Height, 360 Degree Swivel, Tilt-Tension, Tilt-Lock



BK Black
Antimicrobial
PU Leather

PROVIDENT



SIERRA



A Executive High Back w/Black Base 10311A

Overall: 26½"W x 28½"D x 41½-44"H
Seat: 21¼"W x 21"D x 18½-21¼"H
List: \$936.00

Functions: Adjustable Seat Height, 360 Degree Swivel, Tilt-Tension, Tilt-Lock

B Executive Mid Back w/Black Base 10321A

Overall: 26½"W x 28"D x 38½-41½"H
Seat: 21¼"W x 21"D x 18½-21¼"H
List: \$868.00

Functions: Adjustable Seat Height, 360 Degree Swivel, Tilt-Tension, Tilt-Lock



BK Black
Antimicrobial
PU Leather



Note: Contour, Provident & Sierra chairs can be shipped by a small package carrier. 



ADVANTAGE

Pictured w/Variant

A Executive High Back Chair w/Black Base 1201V

Overall: 24"W x 26¼"D x 40¼"-44"H
Seat: 19¾"W x 18¼"D x 18¾"-22¼"H
List: \$436.00

Functions: Adjustable Seat Height, 360
Degree Swivel, Tilt-Tension, Tilt-Lock

B Executive Mid Back Chair w/Black Base 1206V

Overall: 24"W x 26¼"D x 37¼"-40¾"H
Seat: 19¾"W x 18¼"D x 18½"-22"H
List: \$396.00

Functions: Adjustable Seat Height, 360
Degree Swivel, Tilt-Tension, Tilt-Lock

CHAIR FEATURES



Chair comes with a tilt tension
and tilt lock function with a
waterfall edge seat

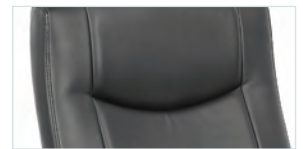

Crafted to take care of your
posture during the long hours
you spend at the office

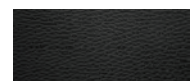

BK Black PU Leather

Note: Advantage chairs can be shipped
by a small package carrier. 📦





Pictured w/OS Laminate - OS89 Typical

RYDE BIG & TALL

Big & Tall High Back Gray Mesh Task Chair w/Flip Arms & Black Frame 2101HMFBT

Weight Capacity: 400 LBS

Overall: 31"W x 30"D x 43¹³/₁₆"-46³/₄"H

Seat: 22¹/₂"W x 21"D x 18¹⁵/₁₆"-21⁷/₈"H

List: \$1,520.00

Functions: Adjustable Seat Height, 360 Degree Swivel, Adjustable Lumbar Support, Tilt-Tension, Tilt-Lock, Height Adjustable Arms, Flip-up Arms

CHAIR DESIGN

Mesh hard back with adjustable lumbar support with a spring pack seat construction for added support and comfort



GRBK Black Fabric

Note: Ryde Big & Tall chair can be shipped by a small package carrier. 📦



Weight Capacity
400 LBS



Padded armrests flip up and down and are also height adjustable for optimal ergonomic performance

BIG & TALL



Weight Capacity
400 LBS

Mesh Back Executive Chair w/Heavy-Duty Chrome Base 05AB2QHBV

Weight Capacity: 400 LBS

Overall: 27"W x 31"D x 39½-42½"H

Seat: 22¾"W x 19¾"D x 18¼-21¼"H

List: \$1,099.00

Function: Adjustable Seat Height, 360 Degree Swivel, Adjustable Lumbar Support, Tilt-Tension, Synchro-Tilt, Tilt-Lock, Multi-Position Back Lock, Height Adjustable Arms



BK Black
Bonded Leather

CHAIR DESIGN

Chair features adjustable lumbar support with a unique design that combines plastic and chrome



BIG & TALL



A

Weight Capacity
400 LBS

A Big & Tall High Back Chair w/Black Base 44088AF

Weight Capacity: 400 LBS

Overall: 28¾"W x 27¼"D x 41¾-44¾"H

Seat: 22½"W x 18¾"D x 17¾-20¾"H

List: \$1,185.00

Functions: Adjustable Seat Height, 360 Degree Swivel, Tilt-Tension, Tilt-Lock, Height Adjustable Arms



BK Black Fabric
w/Mesh Back

B Mesh Back Guest Chair w/Arms & Black Frame 11789F

Weight Capacity: 350 LBS

Overall: 24¾"W x 25"D x 39½"H

Seat: 22"W x 19¼"D x 18¾"H

List: \$727.00



BK Black Fabric
w/Mesh Back



B

Weight Capacity
350 LBS

CHAIR DESIGN

Chair features a sturdy, durable back with padded armrests for optimal comfort all around



Note: Big & Tall chairs on this page can be shipped by a small package carrier. 📦

BIG & TALL



Weight
Capacity
500 LBS



Pictured w/OS Laminate

Big & Tall High Back Chair w/Black Base

11667L

Weight Capacity: 500 LBS

Overall: 29 $\frac{1}{16}$ "W x 34 $\frac{1}{16}$ "D x 46 $\frac{5}{8}$ -50 $\frac{13}{16}$ "H

Seat: 25 $\frac{5}{8}$ "W x 22 $\frac{1}{16}$ "D x 20 $\frac{5}{8}$ -24 $\frac{7}{16}$ "H

List: \$1,477.00

Functions: Adjustable Seat Height, 360 Degree Swivel, Tilt-Tension, Tilt-Lock



BK Black
Bonded Leather

BIG & TALL



Weight
Capacity
400 LBS

Big & Tall, Executive High Back Chair w/Black Frame

991V

Weight Capacity: 400 LBS

Overall: 33 $\frac{1}{2}$ "W x 31"D x 43-45 $\frac{1}{2}$ "H

Seat: 22 $\frac{1}{2}$ "W x 21"D x 20 $\frac{1}{4}$ -23"H

List: \$1,126.00

Functions: Adjustable Seat Height, 360 Degree Swivel, Tilt-Tension, Tilt-Lock



BK Black PU Leather

CHAIR DESIGN

Chair features additional extra padding for a comfortable seat during those long work hours



Note: 991 can be shipped by a small package carrier.



BIG & TALL



Weight
Capacity
400 LBS

Big & Tall High Back Chair w/Chrome Frame 21041A

Weight Capacity: 400 LBS

Overall: 28½"W x 31"D x 44¼-47"H

Seat: 24¼"W x 19¾"D x 19¼-22"H

List: \$1,494.00

*Functions: Adjustable Seat Height, 360
Degree Swivel, Tilt-Tension, Tilt-Lock*



BK Black
Antimicrobial
PU Leather

CHAIR DESIGN

*Heavy-duty, butterfly
mechanism puts tilt and
lock at start position*



Pictured w/OS Laminate - OS239 Typical

BIG & TALL



Weight
Capacity
400 LBS

Big & Tall Executive w/Silver Heavy-Duty Metal Base 993L

Weight Capacity: 400 LBS

Overall: 27"W x 31"D x 43½-46½"H

Seat: 21½"W x 18"D x 19½-22½"H

List: \$1,063.00

*Functions: Adjustable Seat Height, 360
Degree Swivel, Tilt-Tension, Tilt-Lock*



BK Black
Bonded Leather

CHAIR DESIGN

*Chair features fixed,
heavy-duty loops arms
with padded armrests
for optimal comfort*



Note: 993 can be shipped by a small package carrier.



BIG & TALL



Weight
Capacity
500 LBS

**Guest Chair w/Silver Frame
11499V**

Weight Capacity: 500 LBS

Overall: 30³/₄"W x 28³/₄"D x 34¹/₄"H

Seat: 27"W x 19¹/₂"D x 19¹/₆"H

List: \$1,131.00



Weight
Capacity
275 LBS

**Guest Chair w/Silver Frame
11494V**

Weight Capacity: 275 LBS

Overall: 26⁷/₁₆"W x 28³/₄"D x 34¹/₁₆"H

Seat: 23¹/₂"W x 19¹/₂"D x 19¹/₄"H

List: \$947.00



Weight
Capacity
500 LBS

**Bench w/Silver Frame
11490V**

Weight Capacity: 500 LBS

Overall: 43⁵/₁₆"W x 18¹/₂"D x 18⁹/₁₆"H

Seat: 43⁵/₁₆"W x 18¹/₂"D x 18⁹/₁₆"H

List: \$746.00

FEATURES

- Medical-grade, easy to clean vinyl
- Wall saver back leg design
- Heavy-duty construction



CHAIR FEATURES

Waterfall seat cushion design helps to prevent leg fatigue over time



BK Black PU Leather

BIG & TALL



Weight Capacity
500 LBS

Guest Chair w/Arms & Black Frame
59051FPA (Black Antimicrobial Vinyl Only)
Weight Capacity: 500 LBS
Overall: 32"W x 25"D x 33"H
Seat: 26"W x 19½"D x 18"H
List: \$792.00



Weight Capacity
400 LBS

Armless, Guest Chair w/Black Frame
59054FPA
Weight Capacity: 400 LBS
Overall: 26"W x 22"D x 33"H
Seat: 22½"W x 19"D x 18"H
List: \$602.00



59054FPA Shown - Profile View



Weight Capacity
400 LBS

Guest Chair w/Arms & Black Frame
59052FPA
Weight Capacity: 400 LBS
Overall: 27½"W x 24"D x 33"H
Seat: 22½"W x 19"D x 18"H
List: \$651.00



Weight Capacity
300 LBS

Guest Chair w/Arms & Black Frame
59053FPA
Weight Capacity: 300 LBS
Overall: 22"W x 23½"D x 33"H
Seat: 19"W x 18½"D x 18"H
List: \$538.00



59053FPA Shown - Front View

FEATURES

- Medical-grade, easy to clean antimicrobial vinyl
- Wall saver back leg design with waterfall seat cushion
- Heavy-duty construction
- Adjustable levelers on all back legs of chairs helps with uneven floor surfaces

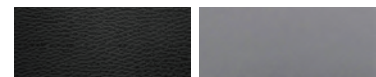

BK Black
Antimicrobial Vinyl

GR Gray
Antimicrobial Vinyl

Note: Big & Tall chairs on this page can be shipped by a small package carrier. 📦



WHAT TO LOOK FOR IN AN OFFICE CHAIR

CHAIR GUIDE FUNCTION GLOSSARY:

Proportional Adjustments	
Adjustable Seat Height	Adjusts the seat up and down to accommodate various body heights.
Ratchet Back	Allows the back of the chair to ratchet up or down in stages.
Seat Depth Adjustment	Adjusts the seat forward or backward to adjust to upper leg length.
Seat Slider	Moves the seat cushion forward or backward for additional seat depth.

Posture Controls	
360 Swivel Degree	Provides freedom of movement for the seat in any direction.
Adjustable Lumbar Support	Easily adjusts to custom fit your lumbar for optimal comfort and lower back support.
Tilt-Tension	Controls the resistance and rate of how the chair reclines.
Synchro-Tilt	Mechanism reclines the back at a higher ratio than the seat for proper back alignment.
Weight-Activated Recline	Mechanism will automatically adjust the synchro tension based on the user's weight.
Tilt-Lock	Locks the seat and back in an upright position.
Forward Seat-Tilt	Allows the seat to tilt forward for enhanced comfort when doing intensive forward-oriented tasks.
Knee-Tilt	Reclines the back at a higher ratio than the seat for proper back alignment. Pivot point is located near the front of the seat.
Independent Back Angle	Adjusts the angle of the back separately from the seat to reduce pressure on the lower spine.
Multi-Position Back Lock	Allows the user to adjust and lock the seat and back angle of the chair independently of each other.

Arm Adjustments	
Height Adjustable Arms	Moves up or down for shoulder and upper body support.
Width Adjustable Arms	Moves the arms toward and away from the body to adapt to various body sizes.
Height & Width Adjustable Arms	Moves up and down, and towards and away from the body to adapt to various body sizes.
All Adjustable Arms	Arms adjust in height, width, depth, and pivot.
Flip-up Arms	Arms flip up and back down into a fixed position.

THE RIGHT FIT:

Finding the perfect chair requires striking a balance between style, price, and ergonomics. Understanding the various adjustments and features is the first step to helping your posture and making those long office hours as comfortable as possible.

Big & Tall

6'2" or taller. Maximum weight limit on Big & Tall chairs is 350-400 lbs. *Max weight is variable and noted in catalog.

Standard

Up to 6'2". Maximum weight limit on Average chairs is 275 lbs.

ADDITIONAL CHAIR ACCESSORY OPTIONS

OPTIONAL CHAIR SEAT COVERS

Optional Interchangeable Seat Cover

656COVERF (Fabric)

656COVERA (Antimicrobial Vinyl)

Fabric Cover List: \$30.00

Antimicrobial Vinyl Cover List: \$30.00

FEATURES

- Interchangeable seat covers are the solution for anyone who likes to change up the look of their office space
- You can change as many times as you like while still offering comfort and durability
- They are easy to take off for cleaning and replacement
- Offered in a brilliant variety of fabric colors and antimicrobial vinyl; vinyl is great for healthcare or high use cleaning environments
- These seat covers will fit most chairs

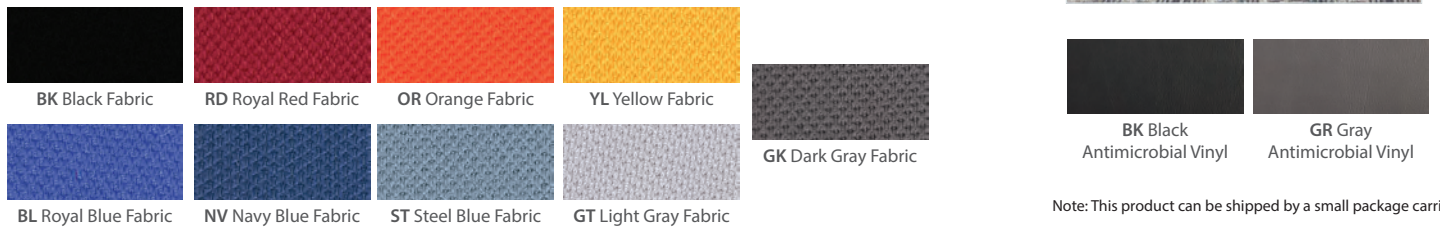

Note: This product can be shipped by a small package carrier. 📦

OPTIONAL CASTERS & GLIDES

A Soft Dual Wheel Casters

CASTERSPUBK

List: \$55.00



BK Black

B Optional Chair Glides

2700GLIDESBK

List: \$53.00

C Optional Chair Glides

NORGLIDESBK

List: \$49.00



FEATURES

- Soft casters are made for hard flooring to prevent the natural wear and tear of your chair moving across your floor
- Glides make it easy to move your chair from one place to another without damaging your floor at all; screws are included with all glides
- Easily customize your task, mesh or guest seating with optional casters and glides to suit any office environment
- These are made to fit most chair models

Note: Check with your customer representative for any questions on compatibility issues.

Note: Products A, B & C can be shipped by a small package carrier. 📦

OPTIONAL CHAIR CYLINDERS



Optional 100mm Cylinder

NORCYLBK

List: \$51.00



BK Black

FEATURES

- Weight Capacity of 275 lbs.
- Compatible with most mechanisms and chair bases
- Has an additional 20mm gas lift
- Longer or taller cylinders allow the chair height to be higher than standard height
- Cylinder roughly adds an additional 3/4"H

Note: Check with your customer representative for any questions on compatibility issues.

Note: This product can be shipped by a small package carrier. 📦

LAMINATE BOOKCASES

FEATURES

- Finished, solid wooden back for heavy-duty use with a matching laminate
- 3mm PVC Dura-Edge on all exposed edges
- Spacious shelves
- Optional doors or 1" thick shelf
- Weight capacity of 50 lbs. per shelf



A Bookcase w/2 Shelves
PL154†
31½"W x 14"D x 29½"H
List: \$359.00



B Bookcase w/4 Shelves
PL155†
31½"W x 14"D x 47¼"H
List: \$472.00



C Bookcase w/6 Shelves
PL156†
31½"W x 14"D x 71"H
List: \$670.00



D Door Kit (Optional)
PLBCDK†
(For PL154, PL155 & PL156)
List: \$253.00

Some items in this collection come ready-to-assemble.



Pairs Well With OS Laminate Desks - OS239 Typical



F Corner Bookcase
w/2 Shelves
PL160
24"W x 24"D x 30"H
List: \$716.00



G Corner Bookcase
w/3 Shelves
PL161
15"W x 15"D x 36"H
List: \$519.00

Note: PL160 & PL161 Are Not Available In MA Maple or WH White.



NEW! AE American Elm (†Select SKUs)

CG Coastal Gray

ES Espresso

MW Modern Walnut

MH Mahogany

CH Cherry

WH White
(Select SKUs)

MA Maple
(Select SKUs)

Note: American Elm only available for select SKUs. Select SKUs are notated by a † mark at the end of their SKU.

STEEL BOOKCASES



A 6 Shelves
QSOSB6SLF82
 34½"W x 13"D x 82"H
 List: \$1,440.00

B 5 Shelves
OSB5SLF72
 34½"W x 13"D x 72"H
 List: \$1,232.00

C 4 Shelves
QSOSB4SLF60
 34½"W x 13"D x 60"H
 List: \$1,098.00

D 3 Shelves
QSOSB3SLF42
 34½"W x 13"D x 42"H
 List: \$840.00

E 2 Shelves
QSOSB2SLF30
 34½"W x 13"D x 30"H
 List: \$707.00

Note: OSB5SLF72 Stocked in Black & Light Gray Only. Putty is available through QuickShip Only.



QS = QUICKSHIP Most Items in this collection come fully assembled.

HEAVY DUTY WIRE RACKS



A Wire Shelving Unit
PWS722148
 Shelf Capacity: 250 lbs.
 48"W x 21"D x 72"H
 List: \$713.00

B Wire Shelving Unit
PWS722136
 Shelf Capacity: 300 lbs.
 36"W x 21"D x 72"H
 List: \$590.00



BK Black Metal

OPTIONAL SHELF

36"W Extra Shelf
 (Compatible w/PWS722136)
PWS1236
 List: \$77.00 ea.

48"W Extra Shelf
 (Compatible w/PWS722148)
PWS1248
 List: \$130.00 ea.



OS LAMINATE LATERAL FILES



A 2 Drawer Lateral
PL112†

35½"W x 22"D x 29½"H
List: \$1,248.00

B 3 Drawer Lateral
PL183†

35½"W x 22"D x 42"H
List: \$2,948.00

C 4 Drawer Lateral
PL184†

35½"W x 22"D x 54½"H
List: \$3,612.00

D Combo Lateral B/B/F
w/One Lateral File

PL114†
31"W x 22"D x 29½"H
List: \$1,409.00

Note: Lateral files are for the storage of hanging file folders only and not for the storage of heavier objects.



NEW! AE American Elm
(†Select SKUs)

CG Coastal Gray

ES Espresso

MW Modern Walnut

MH Mahogany

CH Cherry

WH White

MA Maple

Note: American Elm **only** available for select SKUs. Select SKUs are notated by a † mark at the end of their SKU.

Some items in this collection come ready-to-assemble.

LATERAL FILES

FEATURES

- Safety features include counter weights and an interlock system to prevent tipping
- Core-removable locks
- Heavy-duty full pull designer cabinet at an affordable price
- Reinforced heavy-gauge welded steel construction
- Standard with factory installed lock and hanging bars
- Powder coat paint
- Meets or exceeds ANSI/BIFMA performance standards

35½" Wide – Lateral Files

A 2 Drawer Metal File
8362

35½"W x 19¾"D x 27½"H
List: \$1,203.00

B 3 Drawer Metal File
8363

35½"W x 19¾"D x 39¾"H
List: \$1,744.00

C 4 Drawer Metal File
8364

35½"W x 19¾"D x 51¾"H
List: \$2,119.00

D 5 Drawer Metal File
8365

35½"W x 19¾"D x 63¾"H
List: \$2,981.00



ADDITIONAL PRODUCTS

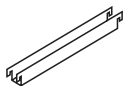

Double Front To Back
Hanging Filing Rail
8000FB
(BK Black)
List: \$49.00 (Pair)



Replacement Lock
Core w/Removal Key
8000COMPLETEKIT
(SI Silver)
List: \$127.00



Master Key
8000MASTERKEY
List: \$39.00 ea.



BK Black

GT Light Gray

Most Items in this collection come fully assembled.

Note: 8000FB, 8000COMPLETEKIT & 8000MASTERKEY can be shipped by a small package carrier.

STEEL LATERAL FILES

FEATURES

- Commercial grade ball-bearing suspension allows fully loaded drawers to open with ease
- Durable, fully assembled steel construction with non-porous surface that is easy to clean with a powder coat finish
- Hang rails, counterweights, four adjustable leveling glides and magnetic label holders included
- Core-removable locks allow for simple replacement of existing locks; lock included to keep all drawers secured
- Reinforced base construction for extra structural rigidity as well as a drawer interlock system to inhibit tip-over
- Dual lock bars secure both sides of drawers; accommodates letter, legal, and A4 size hanging files
- Full-width, J-Pull handles
- Meets or exceeds ANSI/BIFMA standards; GreenGuard Gold Certified
- For the storage of hanging file folders only



30" Wide – Lateral Files

2 Drawer File

QSOSL2DRW30

30"W x 18 $\frac{5}{8}$ "D x 28"H

List: \$1,672.00

3 Drawer File

QSOSL3DRW30

30"W x 18 $\frac{5}{8}$ "D x 40 $\frac{1}{4}$ "H

List: \$2,099.00

4 Drawer File

QSOSL4DRW30

30"W x 18 $\frac{5}{8}$ "D x 52 $\frac{1}{2}$ "H

List: \$2,472.00

5 Drawer File

QSOSL5DRW30

30"W x 18 $\frac{5}{8}$ "D x 67 $\frac{5}{8}$ "H

List: \$3,366.00

36" Wide – Lateral Files

2 Drawer File

QSOSL2DRW36

36"W x 18 $\frac{5}{8}$ "D x 28"H

List: \$1,768.00

3 Drawer File

QSOSL3DRW36

36"W x 18 $\frac{5}{8}$ "D x 40 $\frac{1}{4}$ "H

List: \$2,259.00

4 Drawer File

QSOSL4DRW36

36"W x 18 $\frac{5}{8}$ "D x 52 $\frac{1}{2}$ "H

List: \$2,673.00

5 Drawer File

QSOSL5DRW36

36"W x 18 $\frac{5}{8}$ "D x 67 $\frac{5}{8}$ "H

List: \$3,617.00

42" Wide – Lateral Files

2 Drawer File

QSOSL2DRW42

42"W x 18 $\frac{5}{8}$ "D x 28"H

List: \$1,905.00

3 Drawer File

QSOSL3DRW42

42"W x 18 $\frac{5}{8}$ "D x 40 $\frac{1}{4}$ "H

List: \$2,405.00

4 Drawer File

QSOSL4DRW42

42"W x 18 $\frac{5}{8}$ "D x 52 $\frac{1}{2}$ "H

List: \$2,843.00

5 Drawer File

QSOSL5DRW42

42"W x 18 $\frac{5}{8}$ "D x 67 $\frac{5}{8}$ "H

List: \$3,857.00



BK Black

GT Light Gray

PT Putty

CR Charcoal

MT Medium Tone

(42"W Files Only)

QS = QUICKSHIP

Most items in this collection come fully assembled.

BENCHING CABINET



2 Drawer Metal File 836BF

35 $\frac{1}{2}$ "W x 19 $\frac{3}{4}$ "D x 20"H

List: \$1,286.00



SI Silver

OPTIONAL CASTERS

Heavy Duty Caster Base 83CASTERS

(BK Black)

List: \$147.00 (Set of 4)



OPTIONAL LEGS

Sofa Leg Metal Base 83SL

(SI Silver)

List: \$85.00 (Set of 4)



Note: 83CASTERS & 83SL can be shipped by a small package carrier.

STORAGE & WARDROBE CABINETS



A Double Door Cabinet
PL151†
35½"W x 22"D x 65½"H
List: \$1,733.00



B Wardrobe Cabinet
PL207†
24¼"W x 23¾"D x 65½"H
List: \$2,507.00



C Personal Wardrobe Storage Cabinet
PL150
17¾"W x 23¾"D x 65½"H
List: \$1,329.00



D Storage Buffet
PL172†
35½"W x 22"D x 37¾"H
List: \$1,696.00



E 2 Drawer Lateral File
PL112†
35½"W x 22"D x 29½"H
List: \$1,248.00



F Double Door Cabinet
PL152†
35½"W x 22"D x 37¼"H
List: \$1,050.00



G Open Hutch
PL153†
35½"W x 14"D x 36"H
List: \$608.00



Combine PL112, PL152 or PL153 together for additional storage options

OPTIONAL DOORS

H Tempered Glass Cabinet Doors w/Silver Frame
PL150151SGD
(For PL150 & PL151)
List: \$450.00

Note: (1) Per Box, Order (2) for Complete Coverage On PL151.

I Tempered Glass Cabinet Doors w/Silver Frame
PL1525GD
(For PL152)
List: \$737.00 (Set of 2)



NEW! AE American Elm
(†Select SKUs)

CG Coastal Gray

ES Espresso

MW Modern Walnut

MH Mahogany

CH Cherry

WH White

MA Maple

Note: American Elm only available for select SKUs. Select SKUs are noted by a † mark at the end of their SKU.

Some items in this collection come ready-to-assemble.

STEEL STORAGE CABINETS

FEATURES

- 180 lb. shelf capacity; evenly distributed
- Four adjustable shelves; Two adjustable shelves for 42"H cabinets
- Shelves are adjustable in 1" increments
- Recessed handle with core-removable lock
- Durable, fully-welded heavy-gauge steel construction
- The cabinet dolly is adjustable to 30", 36" & 42" widths



A



B



C



D



E



F

A Storage Cabinet
QSOSSC3642
 36"W x 18"D x 42"H
 List: \$2,324.00

B Storage Cabinet
OSSC3672
 36"W x 18"D x 72"H
 List: \$2,999.00

C Oversized Storage Cabinet
QSOSOSZ3672
 36"W x 24"D x 72"H
 List: \$4,194.00

D Full Wardrobe
QSOSFW3672
 36"W x 18"D x 72"H
 List: \$3,569.00

E Combo Wardrobe
QSOSWD3672
 36"W x 18"D x 72"H
 List: \$3,666.00

F Janitor Closet
QSOFJC3672
 36"W x 18"D x 72"H
 List: \$3,566.00



BK Black

GT Light Gray

PT Putty

QS = QUICKSHIP

Most Items in this collection come fully assembled.

OPTIONAL DOLLY
Adjustable Commercial
Cabinet Dolly
QSOSCDOLLY
 (BK Black)
 36"W x 18"Dia
 List: \$903.00



Note: OSSC3672 Stocked in Black & Light Gray Only. Putty is available through QuickShip Only.



MOBILE LAMINATE PEDESTALS

Pictured w/NEW! OSTYP303 Typical & Franklin Seating

**A 3 Drawer Pedestal
Box/Box/File
PL148†**
16"W x 22½"D x 28½"H
List: \$946.00

**B 2 Drawer Pedestal
File/File
PL149**
16"W x 22½"D x 28½"H
List: \$988.00

**C 2 Drawer Pedestal
Box/File
PL1007†**
16"W x 22½"D x 22½"H
List: \$769.00

OPTIONAL CUSHION

**Optional Top Cushion
CUSH1623 (For PL1007)**
(BL Celestial Blue & GK Dark Gray)
List: \$237.00



Casters Hidden Behind Laminate
At The Bottom



NEW! AE American Elm
(†Select SKUs)

CG Coastal Gray

ES Espresso

MW Modern Walnut

MH Mahogany

CH Cherry

WH White

MA Maple

Note: American Elm only available for select SKUs. Select SKUs are noted by a † mark at the end of their SKU. Note: Pedestals are not for the storage of heavier objects.

LAMINATE CUBBY

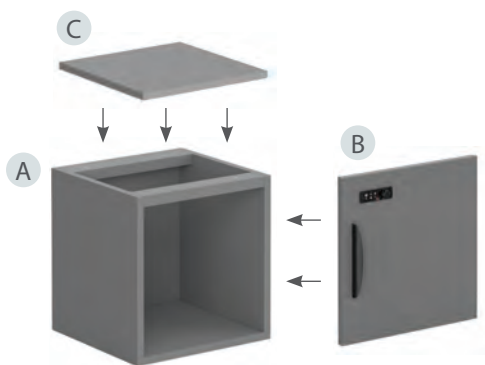

OPTIONAL MINI LEGS

**Straight Metal Mini Legs
PLTSMRLEG**

(BK Matte Black & SI Silver)

List Price: \$171.00 (Set of 4)



Pictured w/Variant & CoolMesh Seating

**A Square Open Cabinet
PL231 (No Door, No Top)**
14⅝"W x 13¾"D x 15"H
List Price: \$187.00

**B Cabinet Door Set
PL231LD**
14⅝"W x ¾"D x 14¾"H
List Price: \$217.00

**C Laminate Top
PL231T (Top Only)**
14⅝"W x ¾"D x 14¾"H
List Price: \$67.00



CR Charcoal

Note: Straight Metal Mini Legs can be shipped by small package carrier. 📦



METAL PEDESTALS

Pictured w/NEW! OSTYP302 Typical & CoolMesh Seating



**A 2 Drawer Pedestal
File/File
CPSFF**
15"W x 22"D x 26¾"H
List: \$676.00



**B 3 Drawer Pedestal
Box/Box/File
CPSBBF**
15"W x 22"D x 26¾"H
List: \$676.00



**C 2 Drawer Pedestal
Box/File
CPSBF**
15"W x 22"D x 22¼"H
List: \$602.00



**D 2 Drawer Hanging
Pedestal - Box/File
CMPBF**
10"W x 20¼"D x 21"H
List: \$571.00



**E Hanging Bracket
w/USB (For CMPBF)
CMPHBUSB**
List: \$242.00

OPTIONAL CUSHION

**Optional Top Cushion
CUSH1019 (For CMPBF Pedestals)**
(BL Celestial Blue & GK Dark Gray)
List: \$216.00



OPTIONAL CUSHION

**Optional Top Cushion
CUSH1522 (For CPS Pedestals)**
(BL Celestial Blue & GK Dark Gray)
List: \$221.00



OPTIONAL CASTERS

**Pedestal Casters
CPPCASTERS**
(BK Matte Black)
List: \$54.00 (Set of 4)



FEATURES

- Free standing
- Sliding ball-bearing suspension drawers for smoother action
- Adjustable glides
- Counter weights & core-removable locks included



METAL OPEN HANGING STORAGE

**A Open Hanging
Storage Pedestal
CPSOHP**
12"W x 15"D x 18½"H
List: \$491.00

**B Reversible Door
w/Lock
CPSOHPDOOR**
15¼"W x 1⅞"D x 10⅞"H
List: \$163.00



FEATURES

- Painted metal finish
- Keep your personal items organized with this space-saving storage option
- Optional door available
- Easily combine with our standing desk options for extra storage



SI Silver





STEEL VERTICAL FILES

FEATURES

- Precision ball-bearing suspension allows drawers to open and close smoothly
- Adjustable follower wires and blocks included will keep files snug and tidy
- Strong, aluminum handles add style while label holders add function
- Core-removable locks allow for simple replacement of existing locks
- Premium construction with high-quality steel and durable components that will withstand everyday use
- Baked enamel finish

26½"Deep – Vertical Files

**2 Drawer File
Letter**
QSOSV2LT26H
 15"W x 28¾"H
 List: \$717.00

**2 Drawer File
Legal**
QSOSV2LG26H
 18"W x 28¾"H
 List: \$778.00

**4 Drawer File
Letter**
QSOSV4LT26H
 15"W x 52"H
 List: \$1,173.00

**4 Drawer File
Legal**
QSOSV4LG26H
 18"W x 52"H
 List: \$1,275.00

**5 Drawer File
Letter**
(Not Pictured)
QSOSV5LT26H
 15"W x 61¾"H
 List: \$1,705.00

**5 Drawer File
Legal**
(Not Pictured)
QSOSV5LG26H
 18"W x 61¾"H
 List: \$1,839.00

25"Deep – Vertical Files

**A 2 Drawer File
Letter**
OSV2LT25
 15"W x 28¾"H
 List: \$668.00

**2 Drawer File
Legal**
QSOSV2LG25
 18"W x 28¾"H
 List: \$749.00

**B 4 Drawer File
Letter**
OSV4LT25
 15"W x 52"H
 List: \$1,118.00

**4 Drawer File
Legal**
QSOSV4LG25
 18"W x 52"H
 List: \$1,249.00



BK Black

GT Light Gray

PT Putty

QS = QUICKSHIP

Most Items in this collection come fully assembled.

MODULAR ELECTRIC SYSTEMS

How To Order:

1. Determine the configurations that need powered and electrical load requirements.
2. Choose **Base Feed**.**
3. Establish placement of **Power Blocks**.
4. Identify **Receptacles** per power block.
5. To figure harness length, take the center of the item, where the power blocks are to be placed, plus the length of any items the harness needs to pass under. Subtract 7" and use the next larger size harness, unless measurement is exactly the size of a harness.

For Example:

Sample #1- The power blocks are centered in the 42" Returns, so half the return size is 21" for each return (21" + 21") plus 30" depth of the peninsula, minus 7".
 $(21" + 21" + 30" - 7" = 65" \text{ harness length})$

6. Determine needed accessories

ADDITIONAL PRODUCTS

BASE FEED

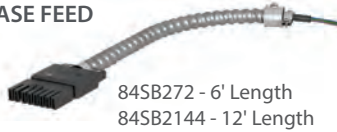

Note: 8 Wire, 4 Circuit System. Must be hardwired by a Licensed Electrician.

HARNESS



POWER BLOCK 84A/78MB*

84S1BL150, 84S2BL150, 84S4BL150

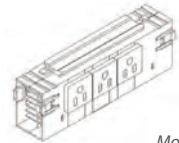

Power Block Does Not Include The Receptacles Pictured.

Block Is Two Sided. Mounting Bracket Included.

CHANNEL & DATA JACK



Metal J Channel
PLTPC18
(BK Black)

- Under Table Mountable
- Accommodates Modular Electric System Items



Data Jack
(For PLTPC18)
ABLAB
(BK Black)

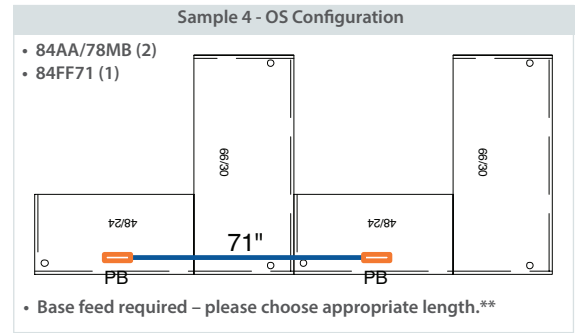
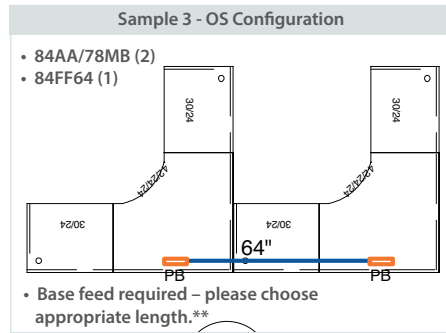
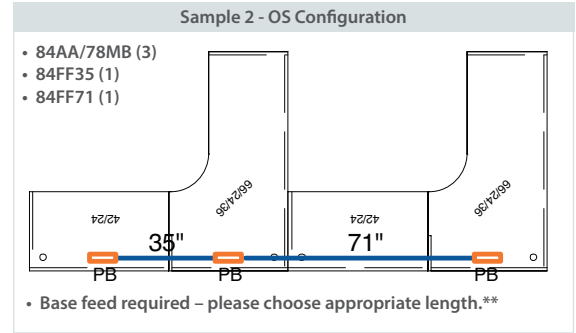
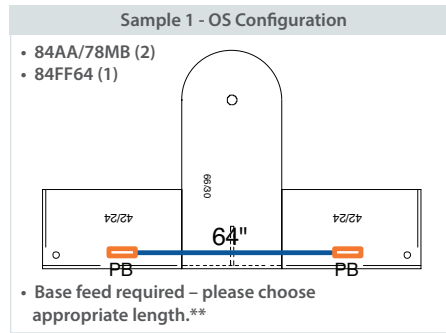

84SB272	72" Multi Circuit Hardwire Whip	\$301.00
QS8420AP1	72" Single Circuit Whip w/20 AMP Plug	\$451.00
QS84SB2144	12' Base Feed (Extra Long)	\$478.00
QSABLAB	Data Jack - RJ11 Cat 3 Phone & RJ45 Cat 6 Data (Use with PLTPC18)	\$197.00
84AA/78MB	Power Block*	\$102.00
84S1BL150	Receptacle 1	\$31.00
84S2BL150	Receptacle 2	\$31.00
84S4BL150	Receptacle 4	\$31.00
84SIGOR150	Isolated Receptacle 3***	\$36.00
QS8SR	Receptacle Removal Tool	\$15.00
PLTPC18	Metal Channel (Under Table Mountable)	\$93.00

QS84FF17	Harness - 17"	\$197.00
QS84FF23	Harness - 23"	\$211.00
QS84FF29	Harness - 29"	\$227.00
QS84FF35	Harness - 35"	\$239.00
QS84FF41	Harness - 41"	\$263.00
QS84FF47	Harness - 47"	\$270.00
84FF53	Harness - 53"	\$286.00
84FF59	Harness - 59"	\$301.00
QS84FF64	Harness - 64"	\$317.00
84FF71	Harness - 71"	\$330.00
QS84FF77	Harness - 77"	\$345.00
QS84FF83	Harness - 83"	\$360.00
QS84FF89	Harness - 89"	\$375.00
QS84FF95	Harness - 95"	\$389.00

*Mounting bracket included.

**Base feed required.

***Isolated receptacles are to protect electronic equipment from electromagnetic noise.

Note: In Some Configurations The Power Block Will Not Be Centered.

Can Be Retrofitted Into New & Existing Furniture

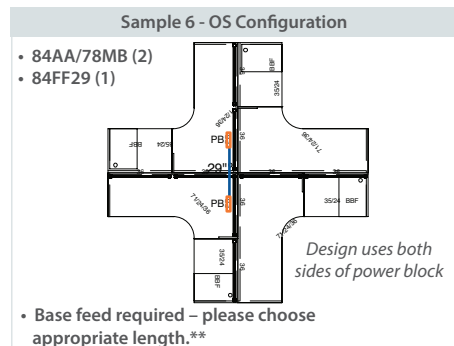

Metal J Channel

For mounting power and data to the underside of a table or to a modesty panel. They are modular and versatile and provide power, data and wire management in a single package. J-Channels can be outfitted with our Electri-Pak wiring systems including our 8 wire, 3 circuit or 8 wire, and 4 circuit systems. Configurations are available in a variety of lengths and can accommodate a wide range of power receptacles in both single circuit and multi-circuit configurations.



A separate channel is provided for housing the telecom plate and keeps the data wires separated from the power cables. Interconnecting cables and power in-feeds are available in a variety of lengths. Power feeds, interconnecting cables and telecom plates are purchased separately.



QS = QUICKSHIP

Note: This collection can be shipped by small package carrier.



MONITOR ARMS

FEATURES

- Grommet & clamp included
- Gas spring control
- 360° rotation, 85° upward, 15° downward
- 2 USB 3.0 ports
- Weight Capacity Per Arm: 20 lbs

A Single Arm
530SMA
(SI Silver)
 List: \$746.00

B Dual Arm
506DMA
(BK Black or SI Silver)
 List: \$543.00

C Dual Arm
530DMA
(SI Silver)
 List: \$1,119.00

D Triple Arm
530TMA
(SI Silver)
 List: \$1,202.00

E Quad Arm
530QMA
(SI Silver)
 List: \$1,865.00

Note: 506 Models fit monitor sizes between 17"-30". 530 Models fit monitor sizes between 10"-30".

Note: All monitor arms can be shipped by small package carrier. 📦

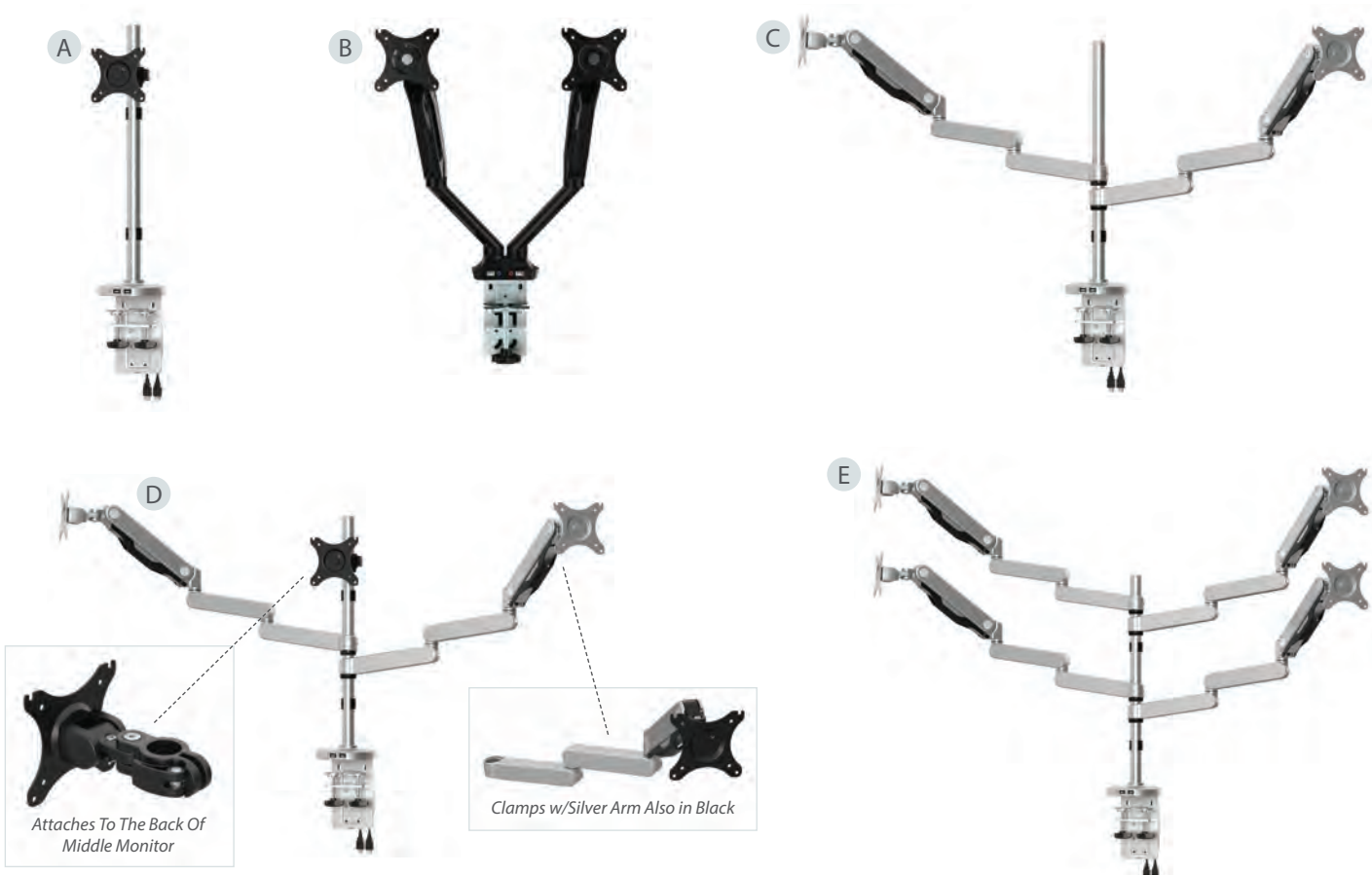

BK Black
(Select SKUs)

SI Silver



Attaches To Underside Of Hutches Easily



Attaches To Underside Of Hutches Easily

LED TASK LIGHTING

24" LED Task Light
PLEDBUDTL24
 List: \$339.00

48" LED Task Light
PLEDBUDTL48
 List: \$506.00



FEATURES

- Features a basic on & off switch
- Extra frosted lens to prevent unwanted glare
- Uses LED light instead of T5 fluorescent light to ensure longevity
- Includes (2) mounting clips and screws
- Implements energy efficient solutions in providing the perfect lighting for your office spaces
- Able to be mounted almost anywhere



BK Black

WIRE MANAGEMENT



30" Spine Cable Management
CMS03
(SI Silver Only)
 List: \$103.00



30" Flexible Cord Concealer



SI Silver



Single Wire Mesh Tray

18" Single Wire Mesh Tray
OSWTSINGLE
(BK Black Only)
 List: \$239.00



18" Power Trough

18" Power Trough w/Cover
PLTPC18
(BK Black Only)
 List: \$93.00



BK Black

Note: CMS03 can be shipped by small package carrier. 📦

HIDDEN GROMMET POWER CENTERS

FEATURES

- Spring-loaded button to open
- Lid sits flush when not in use
- Provides direct access to power and Ethernet
- (3) Power outlets, (2) USB chargers, RJ45
- 8' Power cord
- Overall dimensions: 4 $\frac{3}{8}$ " D
- Cutout hole size: 4 $\frac{1}{8}$ " D
- UL/CUL listed
- 15A, 125V

Note: OSF2000 can be shipped by small package carrier. 

**Hidden Power Grommet
OSF2000**
List: \$214.00



BK Black



Open

Closed



GROMMET POWER CENTER

FEATURES

- Power outlet, (1) USB connection with optional data/charge
- Fits all OS Laminated grommets (2 $\frac{3}{8}$ ")
- Grommet hole: 2 $\frac{3}{8}$ "
- 5' Power cord; 40" USB cable

**Power Grommet
OSF3000**
List: \$171.00



BK Black

Note: OSF3000 can be shipped by small package carrier. 



PULL OUT POWER GROMMET

FEATURES

- (4) Power outlets, (2) USB chargers
- Heavy-duty 8' power cord with surge suppressor w/indicator light
- Fits all OS Laminated grommets (2 $\frac{3}{8}$ ")
- Grommet hole: 2 $\frac{3}{8}$ "
- UL/CUL listed
- 15A, 125V

**Pull-Out Power Grommet
OSF1000**
List: \$233.00



BK Black



Charge Your Laptop Or Phone Easily



Note: OSF1000 can be shipped by small package carrier. 

POWER INSERTS

FEATURES

- (2) Power outlets
- (2) USB 2.0 ports w/(1) USB 3.0 port
- (1) HDMI port
- (1) Data outlet & (1) phone outlet
- 8' Power cord included

Power Insert PLTBPOWER

Cutout: 9½"W x 4½"D
Overall: 10¾"W x 4⅞"D
List: \$874.00



BK Black



SI Silver



Open



Closed



Note: PLTBPOWER can be shipped by small package carrier. 📦

DESK TOP POWER MODULES

FEATURES

- Compact size clamps onto underside of work surface without the need for tools or hardware that fits most table tops
- (2) Power outlets
- (2) Dual USB Type A ports
- 72" Power cord included
- UL Listed
- Adaptive fast charger w/LED light indicators

Desk Mount Power Module OSF9550

4½"W x 5⅝"D x 7"H
List: \$337.00



BK Black

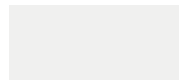

WH White



Note: OSF9550 can be shipped by small package carrier. 📦

DESK TOP POWER MODULES

FEATURES

- Mounts above or below the work surface and includes (3) mounts with an above desk clamp, above desk grommet & below desk mount
- (2) Power outlets and (2) USB ports
- 4' Power cord included w/6'6" GST cord
- Daisy chainable

Desk Mount Power Module OSF9500

6½"W x 3⅝"D x 2⅝"H
List: \$496.00



Below



Above



BK Black

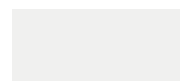

WH White



Note: OSF9500 can be shipped by small package carrier. 📦

NEW! UNDER SURFACE POWER MODULE

FEATURES

- (3) Electrical outlets with two on top and one on the side
- (1) USB-A & (1) USB-C; Daisy chainable
- PCBA surge protection with indicator light and overloaded protection switch
- 118" Power cord included
- 59" USB cable included

NEW! Under Surface Mount OSF5100

List: \$306.00



BK Black

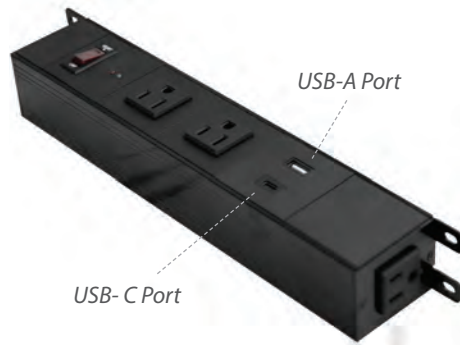

USB-A & USB-C Ports



Able To Be Mounted Below



Easily Plug In Your Devices

Note: OSF5100BK can be shipped by small package carrier.

CENTER DRAWER

Black Center Drawer CDR1

21¼"W x 16¼"D x 2"H

List: \$143.00



BK Black

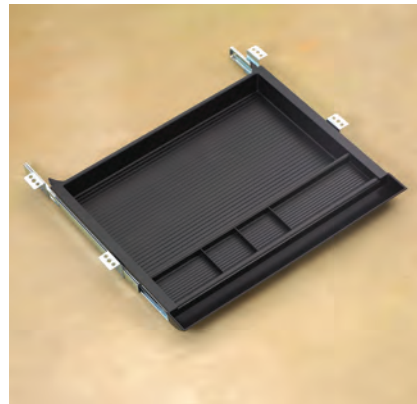

Note: Center drawer is not compatible with Unite Leg Bases, Height Adjustable Leg Bases & Beveled Leg Bases.

FEATURES

- Ball-bearing suspension
- Built-in pencil tray
- Very low profile design, yet handy and functional
- Optional drawer kit for many different work surfaces.
- Keep your accessories organized well and at an arm's length away
- Attaches to most work surfaces easily; assembly required

Note: CDR1 can be shipped by small package carrier.

KEYBOARD SYSTEMS - FOR STANDUP DESKS

Keyboard System w/Nano Arm OSF6500

Keyboard Tray: 28"W x 6¾"D

Mouse Tray: 7½"W x 8½"D

List: \$586.00



BK Black

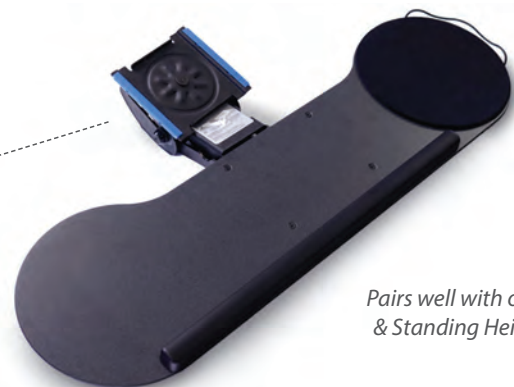

Pairs well with our Variant & Standing Height Desks

KEYBOARD SYSTEMS



**A Slide-Out Keyboard System
OSF500**

Keyboard Tray: 20"W x 11"D
Mouse Tray: 7½"W x 8½"D
List: \$189.00

**B Spring Assist System
OSF600**

Keyboard Tray: 20"W x 11"D
Mouse Tray: 7½"W x 8½"D
List: \$277.00

**C Lift & Lock w/Tear Drop
OSF710**

Keyboard Tray: 20"W x 11"D
Mouse Tray: 7½"W x 8½"D
List: \$395.00

**D Lift & Lock System w/Slide-Out & Swivel
OSF800**

Keyboard Tray: 20½"W x 11"D
Mouse Tray: 7¼"W x 8"D
List: \$496.00

FEATURES

- Includes MDF keyboard & mouse tray with a molded PU palm rest for keyboard systems A, B & D; gel palm rest available for C
- Slides will lock into fully extended position to prevent keyboard tray from moving during use
- MDF mouse tray that swivels right and left
- 21" track available with keyboard systems B, C & D

Note: All keyboard systems can be shipped by small package carrier. 📦



BK Black

CPU HOLDER

FEATURES

- Attaches to the underside of the work surface
- 50 lbs. load capacity and made with all steel
- 180 Degree swivel capability
- Height and width adjustable

**Universal Under Table Mount
CPU Holder**

PLTASCPUH

Inside Dimensions: 5-8¼"W x 11¼"-20¼"H
Overall Dimensions: 6¾"-10"W x 7½"D x 15"-24"H
List: \$298.00



BK Black

Note: This product can be shipped by a small package carrier. 📦



*Easily Mounts Underneath
To Any Workstation*



TEMPERED GLASS CHAIR MATS

Pictured w/OS Laminate - OS266 Typical

FEATURES

- Made with 1/4" clear tempered glass to our patented specifications
- Five times stronger than common glass and can withstand 1,000 lbs.
- Lifetime Limited Warranty against breaking or chipping; scratch resistant
- 99.9% of surveyed buyers say that they are delighted with their glass chair mats for their longevity and easy to clean surface

A GFMRC3648

36"W x 48"D

List: \$305.00

B GFMRC4450

44"W x 50"D

List: \$395.00

C GFMRC4860

48"W x 60"D

List: \$483.00



CL Clear Glass

CHAIR MAT GUIDE

TIPS FOR SELECTING THE RIGHT CHAIR MAT FOR YOUR WORKSPACE

Chair mats are a great accessory for your office. Enjoy a smooth rolling surface that can help reduce stress, fatigue, and floor damage from the repetitive rolling of your office chair. There are three factors to consider when choosing your chair mat:

- Floor type (carpet or hard floors)
- Size of your work area
- Best chair mat shape for your workspace



CARPET TYPES - HOW TO MEASURE

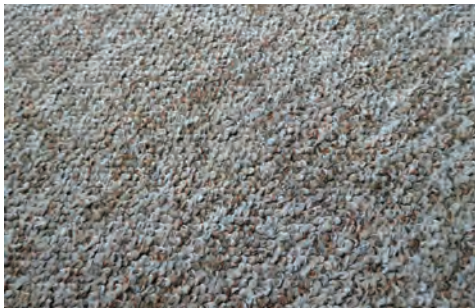

Low Pile Carpet - $\frac{3}{8}$ " inch thick
- Typically found in offices



Medium Pile Carpet - Up to $\frac{3}{4}$ " inch thick
- Typically found in some offices and homes



High Pile Carpet - Up to 1" inch thick
- Typically found in most homes and executive offices

Checking the thickness of your carpet is easy. First, straighten the end of a paperclip and sink it into the carpet, through the padding until it reaches the subfloor. Next, take hold of the paperclip where it meets the surface of the carpet. While holding your measurement in place, measure the distance between your fingers and the end of the paperclip. This will give you the estimated thickness of your carpet with padding included.

Be sure that you're not matting down the carpet with your hand either.

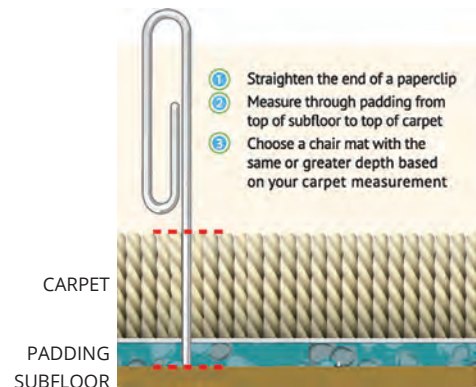
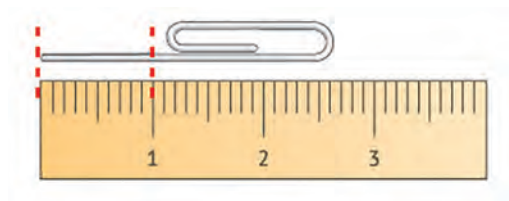

Once you know the thickness of your carpet, then choosing a chair mat will be easy.

EXTENDING THE LIFE OF YOUR CHAIR MAT - CARE & MAINTENANCE

GENERAL CARE TIPS

- Simply wipe clean with a damp cloth and mild soap if needed. Allow chair mat to dry completely before placing it on any surface.
- Ideal temperatures for vinyl chair mats are between 60° and 95°F. Do not place your chair mat in direct sunlight or in areas where moisture is present to reduce the risk of trapping dampness underneath the chair mat.

We have chair mats available in various sizes and materials to suit your private or home office needs!

USING THE RIGHT MAT FOR THE JOB

- It is important that you choose a chair mat that is designed for your type of flooring.
- **Chair Mats for Carpet:** These chair mats have a cleated underside to help secure the chair mat in place. Recommended for carpet use only, do not use on hard floors.
- **Chair Mats for Hard Floors:** These chair mats have a smooth, slightly textured underside (no cleats). Recommended for hard floor use only, do not use on carpeted surfaces.

A BETTER WAY TO WORK



EVERLIFE® CARPET CHAIR MATS FEATURE ANCHORBAR® CLEATS
Easy to handle. Gentle on Carpets and Hands. No sharp spikes.

EVERLIFE®

Extend the life of your flooring by protecting against scuffs, scrapes, and chair caster wear.

An essential addition to your workspace, EverLife® chair mats provide a smooth surface that reduces stress on your legs and back by increasing the mobility of your rolling office chair.

EverLife® chair mats are GREENGUARD Gold Certified for low chemical emissions to promote a healthier indoor workspace.

Made in USA



PROTECT FLOORS FROM WEAR AND TEAR

UNPROTECTED FLOORS



EVERLIFE® CHAIR MAT FOR LOW PILE CARPET

For use on loop/Berber style carpet up to 3/8" thick (including padding). Crystal ramped edge. Limited Lifetime "No Crack Mat" Warranty.

SKU	Size (WxL)	Style	Lip (WxL)	Unit	Price
LP3648NC	36" x 48"	Lip	20" x 10"	EA	\$115.00
LP4553AC	45" x 53"	Lip	25" x 12"	EA	\$140.00
E4860RAC	46" x 60"	Rectangle	No Lip	EA	\$245.00



EVERLIFE® CHAIR MAT FOR MEDIUM PILE CARPET

For everyday office use on carpet up to 3/4" thick (including padding). Limited Lifetime "No Crack Mat" Warranty.

SKU	Size (WxL)	Style	Lip (WxL)	Unit	Price
CRYSTAL EDGE - Smooth, finished edge of superb clarity					
ST3648NBVC	36" x 48"	Lip	20" x 10"	EA	\$165.00
ST4553ABVC	45" x 53"	Lip	25" x 12"	EA	\$185.00
ST4860RBVC	46" x 60"	Rectangle	No Lip	EA	\$275.00

BEVELED EDGE

- Ramped edge for smooth transition on/off mat
ST4553RBVC 45" x 53" Rectangle No Lip EA \$260.00



EVERLIFE® CHAIR MAT FOR HARD FLOORS

Designed to preserve and protect the beauty of laminate, wood, tile and other hard flooring. Straight edge.

SKU	Size (WxL)	Style	Lip (WxL)	Unit	Price
FOR LIGHT USE - 1-YEAR LIMITED "NO CRACK MAT" WARRANTY					
HF3648SE	36" x 48"	Lip	20" x 10"	EA	\$160.00
FOR INTENSIVE USE - LIMITED LIFETIME "NO CRACK MAT" WARRANTY					
HF4553RC	45" x 53"	Rectangle	No Lip	EA	\$230.00
HF4860RC	46" x 60"	Rectangle	No Lip	EA	\$260.00

EVERLIFE® WORKSTATION CHAIR MATS

The contoured design of the workstation chair mat is ideal for L, U and corner style desks.



WORKSTATION CHAIR MAT FOR MEDIUM PILE CARPET

For everyday office use on carpet up to 3/4" thick (including padding). Straight edge. Limited Lifetime "No Crack Mat" Warranty.

SKU	Size (WxL)	Style	Lip (WxL)	Unit	Price
QSST5460ABVC	54" x 60"	Workstation	20" x 12"	EA	\$485.00
QSST6660ABVC	66" x 60"	Workstation	20" x 12"	EA	\$415.00



WORKSTATION CHAIR MAT FOR HARD FLOORS

Designed to preserve and protect the beauty of laminate, wood, tile and other hard flooring. Straight Edge. Limited Lifetime "No Crack Mat" Warranty.

SKU	Size (WxL)	Style	Lip (WxL)	Unit	Price
QSHF5460WS	54" x 60"	Workstation	20" x 12"	EA	\$395.00
QSHF6660WS	66" x 60"	Workstation	20" x 12"	EA	\$415.00

Ask About Our Custom Size Mats!

QS = QUICKSHIP



PEWTER

TRENDSETTER® DESIGNER CHAIR MATS

Transform your space with the beauty of a designer chair mat. Trendsetter® chair mats provide premium floor protection for carpet or hard floor surfaces such as wood, tile and laminate.

Enjoy a smooth rolling surface for increased mobility and ergonomic comfort while protecting your floors from scuffs, scrapes, and chair caster wear.

Trendsetter® Vinyl chair mats are crafted with a durable laminated top layer for a lasting appearance.

Made in the USA.



DARK CHERRY



DRIFTWOOD



TRENDSETTER® CARPET CHAIR MATS FEATURE ANCHORBAR® CLEATS

Easy to handle. Gentle on Carpets and Hands. No sharp spikes.



TRENDSETTER® FOR MEDIUM PILE CARPET

Add beauty to your workspace while protecting your medium pile carpet (up to 3/4" thick including padding) from wear and tear. Straight edge. Limited Lifetime "No Crack Mat" Warranty.

SKU	Size (WxL)	Style	Pattern	Unit	Price
QSMP3648TSPT	36" x 48"	Rectangle	Pewter	EA	\$225.00
QSMP3648TSDW	36" x 48"	Rectangle	Driftwood	EA	\$225.00
QSMP3648TSDC	36" x 48"	Rectangle	Dark Cherry	EA	\$225.00

INSTANTLY ADD STYLE TO YOUR WORKSPACE



DARK CHERRY



DRIFTWOOD

ADD BEAUTY TO YOUR WORKPLACE OR YOUR HOME OFFICE



PEWTER



TRENDSETTER® FOR HARD FLOORS

Add beauty to your workspace while protecting laminate, wood, tile and other hard flooring. Straight edge. 1-Year Limited "No Crack Mat" Warranty.

SKU	Size (WxL)	Style	Pattern	Unit	Price
QSHF3648TSPT	36" x 48"	Rectangle	Pewter	EA	\$175.00
QSHF3648TSDW	36" x 48"	Rectangle	Driftwood	EA	\$175.00
QSHF3648TSDC	36" x 48"	Rectangle	Dark Cherry	EA	\$175.00

QS = QUICKSHIP



SPECIAL ORDER OFFICE FURNITURE

The following vendors covering various industries offer special order products with a plethora of style, fabric and finish choices. Fully furnish offices, classrooms, and multi-purpose rooms, designing a highly customized space. Contact your sales representative for exact timing and details. Lead times can vary greatly, and prices are subject to change.

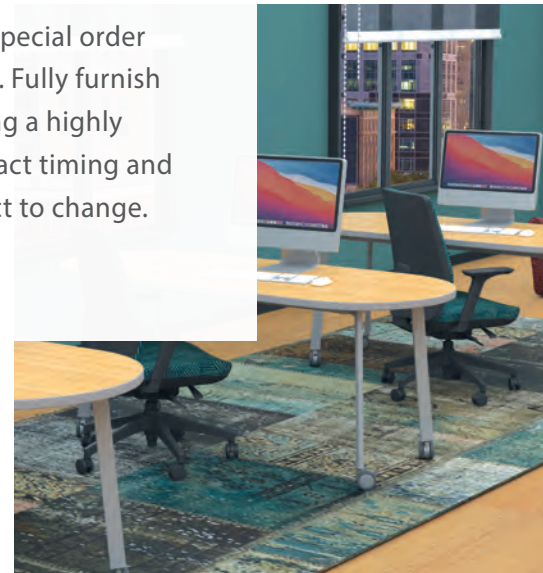
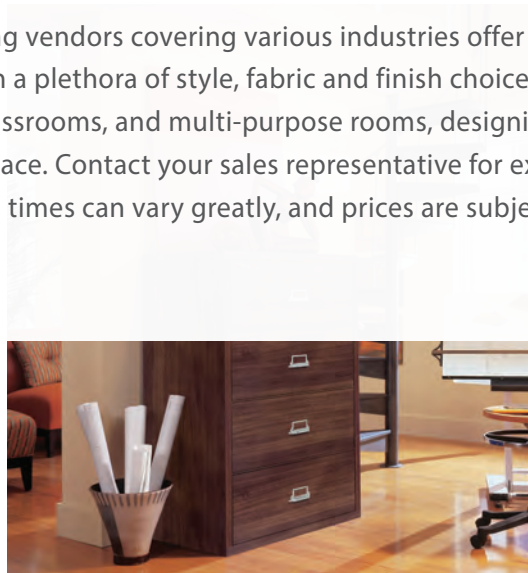
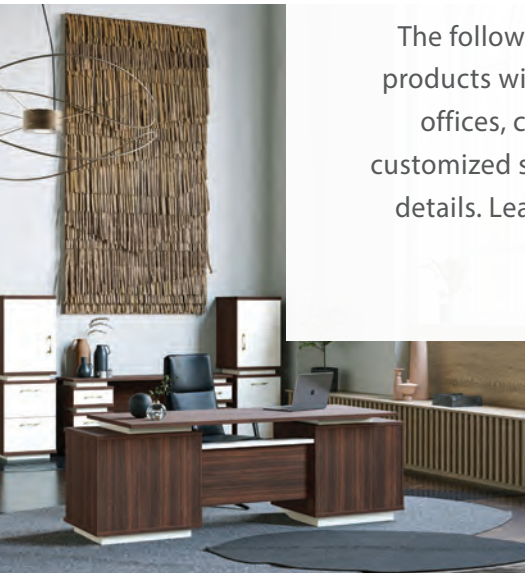

Metal Outdoor Furniture



Laminate & Veneer Desks



Laminate Desks & Components



Educational Lab Furniture



Educational Furniture & Seating



Mobile Dividers & Panels



Akt Lounge Tables & Soft Seating



Fire-Resistant Storage Files

SO = SPECIAL ORDER

We have placed the **SO** prefix before model numbers that are special order items. Please note that lead times on special order items can vary greatly.

QS = QUICKSHIP

We have placed the **QS** prefix before model numbers that are quickship items. Delivery time is approximately 1-3 weeks.

PRICES SUBJECT TO CHANGE. CONTACT US FOR DETAILS.



PARK



A 6' Standard Expanded Metal Bench w/Back
SOB6WBP
 Overall: 72"W x 24"D x 32½"H
 Weight: 150 lbs.

B 6' Standard Expanded Metal Backless Bench
SOB6XPP
 Overall: 72"W x 11½"D x 18½"H
 Weight: 76 lbs.

C 46" Square Expanded Metal Table
SOT46SQP
 Overall: 80"W x 80"D x 29¼"H
 Weight: 265 lbs.

D 72" Square Expanded Metal Picnic Table
SOT6XPP
 Overall: 72"W x 62"D x 29½"H
 Weight: 210 lbs.

E 32 Gallon Receptacle w/Spun Metal Lid & Liner
SO32EXPLNSML
 Overall: 23½"Dia x 28½"H
 Weight: 70 lbs.

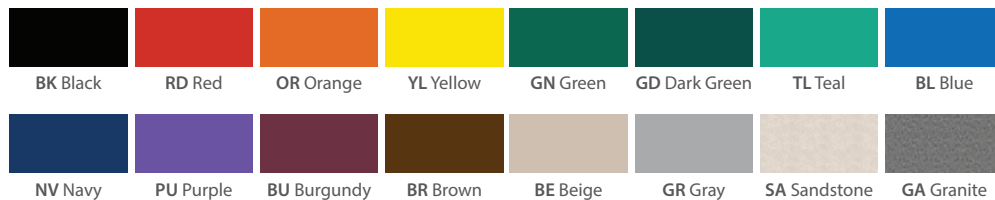

F 46" Round Expanded Metal Table
SOT46ROP
 Overall: 81"W x 81"D x 29¼"H
 Weight: 255 lbs.

MAKE IT PERSONAL

Customize your trash receptacle with a personal logo or words cut into the steel

Please call us for a quote on customization.



SO = SPECIAL ORDER

Some items in this collection come ready-to-assemble.

SO = SPECIAL ORDER

Please contact us for details, lead times & pricing. ADA options are available.



Always stylish, comfortable and effortlessly adaptable, Canvas Laminate enlivens corporate environments with refined aesthetics, born from an appealing mix of materials, finishes, and components. With an enhanced selection of multidimensional components, the creation of an ultra-functional workspace is limited only by your imagination. Create your ideal office today!



CANVAS & GESSO EDGE OPTIONS

Choose from 3 Edge options.



CANVAS & GESSO PULL OPTIONS

Choose from 13 Pull options.



Note: *Pulls also available in Black finish.
**Chrome Studio pull also available in Gold finish.

CANVAS LAMINATE OPTIONS - TFL OR HPL TOPS



SO = SPECIAL ORDER











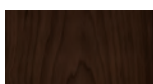

Please contact us for details, lead times & pricing.



A foundational suite of casegoods primed to evolve with your needs. Gesso allows you to combine luxurious veneers, top grade laminates, and other materials to create stylish, reconfigurable work spaces and storage options. An inspiring selection of premium and unexpected details allows you to go a level above in your design.

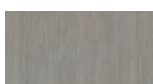

GESSO FINISH OPTIONS - VENEER OR HPL TOPS

							
AW Artisan Walnut	CO Columbian Walnut	EW Espresso	DFW Dk. Forest Walnut	SCH Select Cherry	SKC Shaker Cherry	WC Williamsburg Cherry	
				Note: CO Columbian Walnut, EW Espresso, SCH Select Cherry, WC Williamsburg Cherry, & SKC Shaker Cherry are available in High Pressure Laminate Tops.			
AS Asian Night	ORW Oak Riftwood	WTA Weathered Ash	FO Fawn Oak				

SO = SPECIAL ORDER

Please contact us for details, lead times & pricing.



CONFERENCE TABLES

Any Size, Any Shape, Any Profile, Any Thickness & Any Base



16' Table Top

See Page 244 for Price

Candex Provides Many Customizable Options - Please Call For Details

5 PROFILES - 3 THICKNESSES

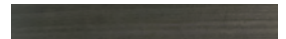

3MM1 (3 Millimeter - 1" Edge)



3MM2 (3 Millimeter - 1" Fluted Edge)



3MM3 (3 Millimeter - 1 1/2" Edge)



3MM5 (3 Millimeter - 1 1/2" Fluted Edge)



3MM4 (3 Millimeter - 2" Scalloped Edge)

5 TABLE BASES



CL1



CL2



CL3



CL4



CL5

SOCANDEX7

Total List: \$7,716.00

Includes: 4' x 16' x 2" Top,

(2) PB1, (3) CL5

Excludes Seating

*Boat Top Made in 2 Piece Top

Side View



Top View



COFFEE / KITCHENETTE



Kitchen Base Unit
SO399KT

90"W x 24"D x 36"H
List: \$2,406.00

Note: Fridge not included.



Coffee Counter
SO22330

30"W x 15"D x 30"H
List: \$1,356.00

The Complete Office - 23-Person Office
In A 40' Ft X 40' Ft (1,600 Sq. Ft Area)

1. Reception (See Pg. 245 for Details)
2. Showroom Area (See Pg. 244 for Details)
3. Storage / Lateral (See Pg. 244 for Details)
4. Lockers (See this Page for Details)
5. Coffee / Kitchenette (See this Page for Details)
6. Manager's Office (See Pg. 245 for Details)
7. Sorter / Storage (See Pg. 244 for Details)
8. Executive Office (See Pg. 245 for Details)
9. Conference Room (See Pg. 242 for Details)
10. Buffet Credenza (See Pg. 244 for Details)



LOCKERS

Locker - 4 Door
SO3MM1533

16"W x 20"D x 70"H
List: \$1,494.00

Note: All 1" material comes with adjustable glides.

Individual locks for each door & solid back



Available In Any Of Candex's 34 Color Options - See Page 245 Including 2-Tone & Edge Treatment Options At No Extra Charge

Candex Provides Many Customizable Options - Please Call For Details

SO = SPECIAL ORDER

Please contact us for details & lead times. Pricing subject to change.

COMPONENT SERIES

42"High - Showroom/Storage/Workstation

POWER of CHOICE

CANDEX
CUSTOM CORP.



Note: All drawers in this series are made in 1/2" white laminate including the bottom (solid bottom) so they can withhold heavy weight.

SOCANDEX3
Total List: \$7,194.00
Includes: 3MM1TOP10842,
3MM1670 (2), 3MM1671

S03MM1TOP10842	Top	108"W x 42"D x 1"H	\$882.00
S03MM1671	Base Unit (Open Compartments+2 Doors)	36"W x 24"D x 41"H	\$1,614.00
S03MM1670	Base Unit (4-Drwr Top+2-Drwr Bottom)	36"W x 24"D x 41"H	\$2,349.00
S03MM1673	Credenza (2-Door+8-Drwrs)	72"W x 20"D x 36"H	\$3,156.00

CREATE & DESIGN

LATERAL FILES/CREDENZAS/STORAGE

** All 1" Thick units come with adjustable glides
* All tall storage units come with matching back 3/8" thick

2 Drawer Lateral/Storage w/Locks - 29"H

		2MMP	3MM1
SO250	72"W x 20"D	\$1,749.00	\$2,124.00
SO263	72"W x 24"D	\$1,920.00	\$2,295.00



4 Drawer Lateral - 29"H

		2MMP	3MM1
SO25050	72"W x 20"D	\$1,926.00	\$2,304.00
SO25053	72"W x 24"D	\$2,136.00	\$2,451.00



4 Door Storage w/Locks - 29"H

		2MMP	3MM1
SO255	72"W x 20"D	\$1,575.00	\$1,953.00
SO244	72"W x 24"D	\$1,770.00	\$2,196.00



Storage Credenza B/F/F-Door-B/B/FL - 29"H

		2MMP	3MM1
SO298	72"W x 20"D	\$1,992.00	\$2,472.00
SO29824	72"W x 24"D	\$1,992.00	\$2,472.00



4 Drwr/4 Door Buffet Height Credenza w/Locks - 36"H

		2MMP	3MM1
SO397	72"W x 20"D	\$2,568.00	\$3,135.00
SO398	72"W x 24"D	\$2,814.00	\$3,462.00



Sorter/Storage

SO3MM1538	36"W x 12"D x 36"H	\$1,902.00
SO3MM1555	36"W x 20"D x 29"H	\$969.00



*Sorter (Top)
*Desk Shelf w/24" Fixed Shelf (Bottom)

SO5777	66"W x 15"D x 30"H	\$3,117.00
SO5H10966	66"W x 30"D x 29"H	\$1,212.00

*Wardrobe - Storage - F/FL - 25"W

(1" Material)**		2MMP	3MM1
SO5866	20"D x 65"H	\$1,953.00	\$2,145.00
SO5867	24"D x 65"H	\$2,091.00	\$2,295.00
SO5868	20"D x 72"H	\$2,049.00	\$2,244.00
SO5869	24"D x 72"H	\$2,196.00	\$2,382.00



*2 Door Storage w/Locks - 72"H

(1" MATERIAL) **		2MMP	3MM1
SO5832	36"W x 20"D	\$1,461.00	\$1,653.00
SO583224	36"W x 24"D	\$1,677.00	\$1,803.00



*2 Drawer Lateral, 2 Door Storage w/Locks - 72"H

(1" Material) **		2MMP	3MM1
SO5830	36"W x 20"D	\$2,118.00	\$2,316.00
SO583024	36"W x 24"D	\$2,265.00	\$2,463.00



Candex Provides Many Customizable Options - Please Call For Details

3MM1 - Available in 34 COLORS (See Page 245)

SO = SPECIAL ORDER

Candex 3MM1 Finishes

All Are Available In All Of Our 34 Colors Including 2-Tone And Edge Treatment At **NO EXTRA CHARGE**

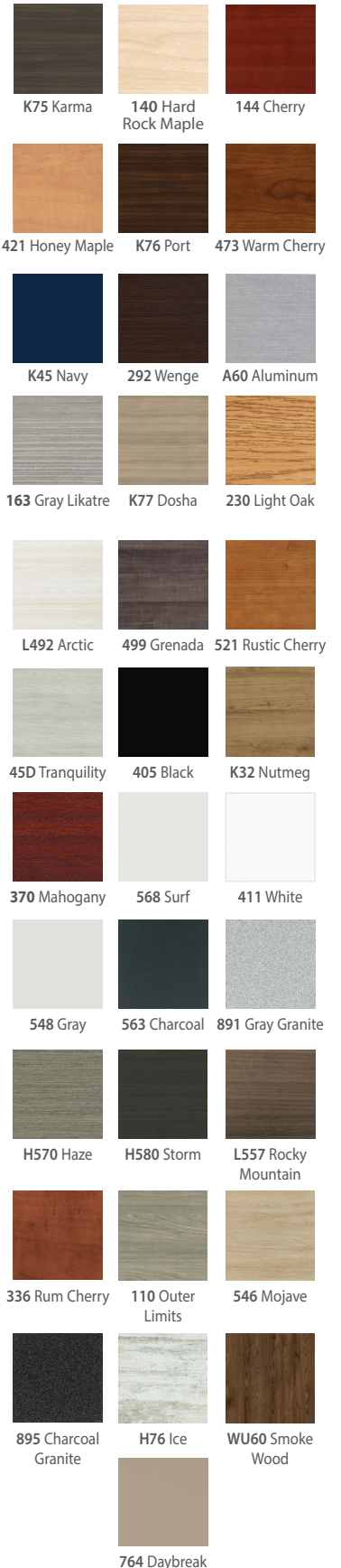

RECEPTION DESK

Also Available With 191 Pedestal

Candex Provides Many Customizable Options - Please Call For Details



1679190



6003190



- SO3MM1679190** Reception Desk - B/B/FL (L or R) w/Insert Cubbies 72"W x 30"D x 42"H \$3,888.00
- SO6003190** Single Pedestal Reception Return - B/B/F 48"W x 24"D x 42"H \$1,590.00



SO = SPECIAL ORDER

Please contact us for details & lead times. Pricing subject to change.



- Double Pedestal Credenza - B/F-B/F**
- SO3MSATI927**
- 20"W x 66"D x 29"H
- List: \$2,727.00



- Sorter Behind Doors With Raised Top & Drawer Front
- Double Pedestal Desk - Door/B/F - Door/B/F**
- SO3MSATI925**
- 30"W x 84"D x 29"H
- List: \$3,249.00

TEACHER'S METAL LEG DESKS

FEATURES

- All laminated wood desk tops with black metal legs. Tops feature rounded corner edges for comfort and safety
- Desk top features a 6" rear overhang for easy student conferencing



A



B

A Teacher's Double 3/4 Pedestal Desk
SO210TERC
72"W x 30"D x 29"H
List: \$1,485.00

Teacher's Double 3/4 Pedestal Desk
SO200TERC
60"W x 30"D x 29"H
List: \$1,395.00

B Teacher's Single 3/4 Pedestal Desk
SO245TERC
48"W x 30"D x 29"H
List: \$1,080.00

Teacher's Single 3/4 Pedestal Desk
SO240TERC
43"W x 24"D x 29"H
List: \$981.00



(230) Light Oak (405) w/Black



(891) Gray Granite (405) w/Black

*34 Desk Top Finishes Available By Special Order
(See Page 245 For Selection)*

SO = SPECIAL ORDER

4000 SERIES ACTIVITY TABLES

All products include 10-year warranty

With unique configurations available in 25 sizes and shapes, these activity tables support a collaborative environment for home, classrooms, training, work, or mail rooms. Available starting at just 24"D.

Please call your sales rep for details & lead times.



RECTANGULAR TOP SIZES

- SO482436** 24" x 36" List: \$500.00
- SO482448** 24" x 48" List: \$539.00
- SO482472** 24" x 72" List: \$739.00
- SO483048** 30" x 48" List: \$559.00
- SO483060** 30" x 60" List: \$679.00
- SO483072** 30" x 72" List: \$760.00
- SO483636** 36" x 36" List: \$539.00
- SO483660** 36" x 60" List: \$700.00
- SO483672** 36" x 72" List: \$780.00

MISC. TOP SIZES

- SO4842R** 42"Dia. Round List: \$669.00
- SO4848R** 48"Dia. Round List: \$821.00
- SO4860R** 60"Dia. Round List: \$1,086.00
- SO484848** 48" x 48" Square List: \$821.00
- SO48KID72** 48" x 72" Kidney List: \$1,350.00
- SO48TRAP60** 30" x 60" Trapezoid List: \$783.00

FEATURES

- All finishes include black edge banding as shown in image
- Lower legs are chrome
- Standard tubular steel legs let you adjust top height from 22" to 30" in one-inch increments
- Sturdy 11/8" thick table tops
- Table edges cushioned with protective t-mold banding

Laminate Tops



Medium Oak Fusion Maple Carmel Sagawood

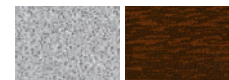

Gray Nebula Walnut

Upper Frame



Silver Mist Char Black

SO = SPECIAL ORDER



CLASSIC SERIES™ CHAIR DESKS



All products include 10-year warranty

Choose from a space-saving tablet arm model or traditional chair desk with a larger work surface. Each model is equipped with a durable high-pressure laminate work surface, under seat steel rod book rack, and stout 1 1/2" tubular steel frame for strength. Additional finish and color options are available. *Please call your sales rep for details & lead times.*



A Tablet-Arm Chair Desk
SO9700BR
 18 3/4"W x 31"D x 30 1/2"H
 Top Surface: 20" x 25 1/2" x 12"
 List: \$612.00
Note: Priced per desk, sold (2) per carton.



B Chair Desk
SO9400BR
 24"W x 36 1/2"D x 30"H
 Top Surface: 18" x 24"
 List: \$643.00
Note: Priced per desk, sold (2) per carton.

Desk Frame



Chrome

Desk Surfaces



Maple

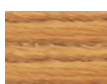

Medium Oak



Walnut



Gray Nebula

Chair Seat Colors

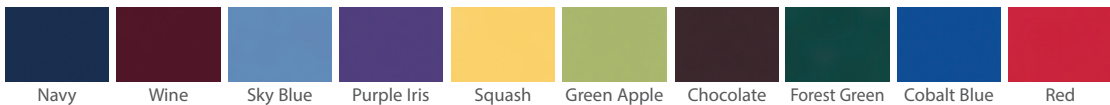

785 SERIES™ STUDENT DESKS

All products include 10-year warranty

Adjustable height, open-front student desks feature a tubular steel frame and built-in plastic book box.

Please call your sales rep for details & lead times.

Open-Front Student Desk

SO785
 24"W x 18"D x 23-31"H
 List: \$355.00

Note: Priced per desk, sold (2) per carton.

Desk Surfaces



Maple



Medium Oak

Desk Frame



Silver Mist



Char Black



Chrome

High Pressure Laminate Tops



SO = SPECIAL ORDER

Please contact us for details & lead times. Pricing subject to change.



3000 SERIES™ STACK CHAIRS & CHAIR DESKS

All products include 10-year warranty

Virco's 3000 Series chair and chair desk models resist stains and scratches, and are also remarkably chip-resistant. Their easily-cleaned hard plastic surfaces retain a bright, fresh look year after year. *Please call your sales rep for details & lead times.*

A Student Chair
18" Seat Height
SO3018

18¾"W x 21½"D x 30½"H
List: \$389.00

B Student Chair
16" Seat Height
SO3016

16½"W x 19½"D x 27⅞"H
List: \$380.00

C Student Chair
14" Seat Height
SO3014

16½"W x 17¼"D x 25¾"H
List: \$355.00

D Student Chair
12" Seat Height
SO3012

14⅝"W x 15"D x 20½"H
List: \$355.00

E Chair Desk
SO3400BRM

22¾"W x 35¾"D x 29⅝"H
Top Surface: 18" x 24"
List: \$868.00

F Tablet-Arm Chair Desk
SO3700BRM

18¾"W x 31"D x 30½"H
Top Surface: 14½" x 20" x 28"
List: \$853.00

Note: All chairs & chair desks priced per each.



QuickShip
3000 Series Seat Colors



Navy

QS = QUICKSHIP

Special Order
3000 Series Seat Colors



Black

Wine



Sky Blue

Forest Green



Sandstone

Red

SO = SPECIAL ORDER

Desk Surfaces



Maple

Medium Oak



Gray Nebula

Desk Frame



Chrome



ZUMA SERIES STACK CHAIRS & STUDENT DESKS

All products include 10-year warranty

The Zuma Series bridges the gap with seating that offers ergonomic support, playful style and durable construction. Student desks come with an adjustable 22"-34" high work surface, these stylish desks are available with nylon-base glides. *Please call your sales rep for details & lead times.*

A Student Chair
18" Seat Height
SOZU418

20⅝"W x 20⅝"D x 32¼"H
List: \$415.00

B Student Chair
15" Seat Height
SOZU415

17⅜"W x 16½"D x 26⅞"H
List: \$378.00

C Student Chair
13" Seat Height
SOZU413

15⅜"W x 14⅞"D x 23¼"H
List: \$357.00

D Student Chair
10" Seat Height
SOZU410

15¼"W x 13¾"D x 20⅝"H
List: \$357.00

E Adjustable Height Student Desk
SOZADJ2026M

24⅜"W x 18⅜"D x 22-34"H
Top Surface: 20" x 26⅞"
List: \$713.00

Desk Surfaces



Maple

Medium Oak

Desk Frame



Silver Mist Char Black



Zuma Series Chair Seat Colors

Note: All chairs & desks priced per each.



STACKS HIGH
4 ↑



CLASSIC SERIES™ STACK CHAIRS

All products include 10-year warranty

Classic student chairs are constructed from highly durable, long-lasting, injection-molded polyethylene featuring a tubular steel frame with one-piece molded polyethylene shell. Available in five varied sizes. *Please call your sales rep for details & lead times.*



QuickShip
Chair Seat Colors



Black (9018 Only) Navy

QS = QUICKSHIP

Special Order
Chair Seat Colors



Navy Wine



Sky Blue Purple Iris



Squash Green Apple



Chocolate Forest Green



Cobalt Blue Red

SO = SPECIAL ORDER



Matching Chair Desks Page 247

A

A Student Chair
18" Seat Height
SO9018
18¾"W x 21½"D x 30⅝"H
List: \$199.00

B Student Chair
16" Seat Height
SO9016
16¾"W x 19½"D x 27"H
List: \$190.00

C Student Chair
14" Seat Height
SO9014
14⅞"W x 17⅞"D x 22⅜"H
List: \$167.00

D Student Chair
12" Seat Height
SO9012
14⅝"W x 15"D x 20⅜"H
List: \$167.00

E Student Chair
10" Seat Height
SO9010
14⅝"W x 15"D x 18⅜"H
List: \$167.00



Note: All chairs priced per chair, but sold (4) per carton.

ZUMA SERIES FLOOR ROCKER

All products include 10-year warranty

For some students and tasks, sitting low to the ground may be just what is needed to create a comfortable and effective learning environment. Sturdy and safe, Floor Rockers feature subtle back and forth motion, offering an ergonomic alternative for floor seating. *Please call your sales rep for details & lead times.*



A FULL-SIZE
Floor Rocker
(5th Grade to Adult)
SOZFLROCK18
18"W x 22½"D x 19½"H
List: \$415.00

B JUNIOR
Floor Rocker
(K to 4th Grade)
SOZFLROCK15
16"W x 21"D x 17¼"H
List: \$378.00



Zuma Series Chair Seat Colors



Graphite Wine Sky Blue Purple Iris Squash Green Apple Chocolate Forest Green Cobalt Blue Red

Please contact us for details & lead times. Pricing subject to change.



EDUCATIONAL LAB FURNITURE

Perpetulab Wooden Leg Tables

These tables are built for years of dependable service. Legs and aprons are constructed of solid red oak. They are finished with a chemical resistant, earth-friendly UV finish. Aprons are constructed of solid red oak and are 13/16"D x 4 1/2"H with heavy-duty 13-gauge steel corner braces. 2 1/4" square solid oak legs, with 5/16" hanger bolts installed, are attached to apron with nuts and washers supplied. All tables are equipped with non-skid adjustable glides for precise leveling and for prevention of rocking on uneven floors. Tables are supplied with black rubber leg boots which offer protection against scuffing and chemical spills. Standard table height is 30" with a weight capacity of 500 lbs. (Shipped KD with tops attached)



QSP710LBBK30N	Oak/Plastic Laminate Top	48"W x 24"D x 30"H
QSP7102K30N	Oak/ChemGuard Top	48"W x 24"D x 30"H
QSP7106K30N	Oak/Solid Epoxy Top	48"W x 24"D x 30"H
QSP720LBBK30N	Oak/Plastic Laminate Top	54"W x 24"D x 30"H
QSP7202K30N	Oak/ChemGuard Top	54"W x 24"D x 30"H
QSP7206K30N	Oak/Solid Epoxy Top	54"W x 24"D x 30"H
QSP7206M30N	Maple/Solid Epoxy Top	54"W x 24"D x 30"H
QSP760LBBK30N	Oak/Plastic Laminate Top	60"W x 24"D x 30"H
QSP7602K30N	Oak/ChemGuard Top	60"W x 24"D x 30"H
QSP7606K30N	Oak/Solid Epoxy Top	60"W x 24"D x 30"H

Fab-Lab Workbench

Perfect for Makerspaces and Fab-Labs. It can be adjusted in height from 27 1/4"H to 35 1/4"H. Add the optional 5" locking casters and you'll add another 6" in height. The legs are 14-gauge steel and have 14-gauge stringers for strength and stability. The steel base is finished with a gray baked enamel finish. The static weight capacity is 1400 lbs. without casters and 1000 lbs. with casters added. Need storage? Add the 14-gauge 12"D shelf. Choose from a 1 3/4" thick maple work surface or the 1 1/2" thick ShopTop.

Pictured w/Optional Casters



QSAMS60305G	Top: Maple	60"W x 30"D x 35 1/2"H
SOAMS60307G	Top: ShopTop	60"W x 30"D x 35 1/2"H
QSAMS72305G	Top: Maple	72"W x 30"D x 35 1/2"H
SOAMS72307G	Top: ShopTop	72"W x 30"D x 35 1/2"H
SOAMS96305G	Top: Maple	96"W x 30"D x 35 1/2"H
SOAMS96307G	Top: ShopTop	96"W x 30"D x 35 1/2"H
SO255588G	18 Gauge Shelf - 60"	60"W x 8"D
SO255589G	18 Gauge Shelf - 72"	72"W x 8"D
SO255590G	18 Gauge Shelf - 96"	96"W x 8"D
SO253996	Heavy Duty Casters (Set of 4)	4"H

Note: Table and base finish is Oak. Top finish is Black Epoxy Resin.



Forward Vision I

This popular workstation allows four students to work at a single station while all are facing the teacher. The unique design leaves enough room to store four stools (not included) under the workstation. Sink units come with two combination cold water/gas fixtures. It comes with two GFI electrical outlets, and ample storage. The door cabinet comes with two adjustable shelves. The station is finished with a chemical resistant, earth-friendly UV finish. All doors and drawers' lock.



QS2946K Solid Epoxy Top 96"W x 50"D x 36"H

Forum Two-Station Workbench

Base consists of a single-faced heavy gauge unit, welded and riveted throughout. The unit provides six locker openings (12"W x 21"D x 15"H). Vented doors have spring loaded hinges, padlock hasp, and knockout plug for cylinder locks. Top is constructed of 2 1/4" maple. Available with or without vises.



SOWB60V	Two-Station/0 Vises (Gray)	64"W x 28"D x 33 1/4"H
SOWB61V	Two-Station/1 Vise (Gray)	64"W x 28"D x 33 1/4"H
SOWB62V	Two-Station/2 Vises (Gray)	64"W x 28"D x 33 1/4"H
SOWB6BL0V	Two-Station/0 Vises (Black)	64"W x 28"D x 33 1/4"H
SOWB6BL1V	Two-Station/1 Vise (Black)	64"W x 28"D x 33 1/4"H
SOWB6BL2V	Two-Station/2 Vises (Black)	64"W x 28"D x 33 1/4"H

Kinetic 5' Instructor Desk



Complete demonstration center constructed of solid oak hardwood and oak veneers. It is finished with a chemical resistant, earth-friendly UV finish. Included are four drawers (three small, one file), and a large cupboard. The drawers are expertly crafted from the finest materials with dovetail joinery throughout. Drawers run on epoxy coated steel glides with nylon bearings for smooth operation. All units come with a GFI protected AC duplex receptacle. Unit comes with combination cold water/gas fixture, and polypropylene trap. Comes standard with pull out writing board, support rod with crossbar, rubber base molding and locks for cupboard and all drawers.

QS1216KL Solid Epoxy Top 60"W x 30"D x 36"H



AVENUU A-FRAME TABLES



FEATURES

- Bring an element of style to any space with this customizable and extremely versatile table
- Available in three widths (48"W, 60"W & 72"W), three depths (36"D, 42"D & 48"D), and two heights (30"H & 36"H) in two frame colors combined with numerous top options providing over 3,000 combinations
- Heavy-gauge metal frame with full tube leg construction & dual-cross top supports
- Includes 4" industrial casters & 3mm PVC edge banding that creates a durable, seamless edge



SOAFT6036WB30C



SOAFT6036LCLS30C

Edge Band Colors

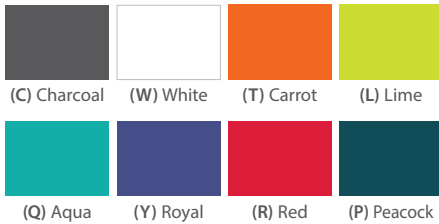

Frame Colors



Top Colors

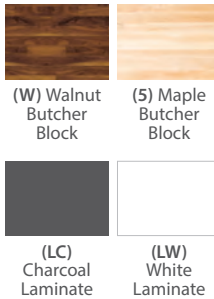

Note: Butcher block tops are 1 3/4" thick. Laminate tops are 1 1/4" thick.

STEEL INDUSTRIAL STOOLS

FEATURES

- Steel Stools are heavy-duty units that are welded and have a 14" seat which includes a recessed, tempered Masonite panel overlay
- Chroma Steel Stools come in a variety of different colors featuring Lotz Armor Edge laminate seats attached to a fully welded frame, the stools are virtually indestructible and the strongest on the market

Steel Stool



Chroma Stool Seat Inset Colors



A 18"H Steel Stool

SOS18
14"D x 18"H

Note: Steel stools only available in gray.

24"H Steel Stool

SOS24
14"D x 24"H

B 18"H Chroma Black Steel Stool

SOSTL7186AH5
14"D x 18"H

Note: Chroma Stool seat colors are for Chroma Stools only.

24"H Chroma Black Steel Stool

SOSTL7186AL5
14"D x 24"H



Non-Marring Glides

SO = SPECIAL ORDER

Please contact us for details, lead times & pricing.

MOBILE SCREENFLEX STANDARD ROOM DIVIDERS



Our best-selling divider provides the flexibility to divide rooms, display material, and absorb sound. With tackable panels and exceptional stability, the Standard divider is the solution for your room dividing needs. The dividers arrive fully assembled and roll on caster wheels into position. Choose from 6 heights and 6 lengths to meet your needs. Room dividers are available in a vinyl or fabric covering. The designer fabrics are treated with fabric protection to resist dirt and stains. Manufacturer's Lifetime Warranty.

Commercial Edition Dividers - Specify Color Code When Ordering						
Length	Height					
	4'-0"	5'-0"	6'-0"	6'-8"	7'-4"	8'-0"
5'-9"	QSCFSL403	QSCFSL503	QSCFSL603	QSCFSL683	QSCFSL743	QSCFSL803
	\$1,413.00	\$1,526.00	\$1,668.00	\$1,853.00	\$2,068.00	\$2,293.00
9'-5"	QSCFSL405	QSCFSL505	QSCFSL605	QSCFSL685	QSCFSL745	QSCFSL805
	\$1,812.00	\$1,953.00	\$2,139.00	\$2,338.00	\$2,580.00	\$2,852.00
13'-1"	QSCFSL407	QSCFSL507	QSCFSL607	QSCFSL687	QSCFSL747	QSCFSL807
	\$2,210.00	\$2,380.00	\$2,594.00	\$2,836.00	\$3,106.00	\$3,406.00
16'-9"	QSCFSL409	QSCFSL509	QSCFSL609	QSCFSL689	QSCFSL749	QSCFSL809
	\$2,607.00	\$2,808.00	\$3,049.00	\$3,320.00	\$3,619.00	\$3,945.00
20'-5"	QSCFSL4011	QSCFSL5011	QSCFSL6011	QSCFSL6811	QSCFSL7411	QSCFSL8011
	\$3,004.00	\$3,263.00	\$3,518.00	\$3,817.00	\$4,144.00	\$4,501.00
24'-1"	QSCFSL4013	QSCFSL5013	QSCFSL6013	QSCFSL6813	QSCFSL7413	QSCFSL8013
	\$3,406.00	\$3,675.00	\$3,975.00	\$4,303.00	\$4,658.00	\$5,041.00



Heavy-Duty Units Available - Please Call For Details

QS = QUICKSHIP



Multi-Unit Connector Option - #GL - \$53.00
Hanging Dry Erase Marker Board Option - #MBF - \$156.00

Commercial Designer Fabrics

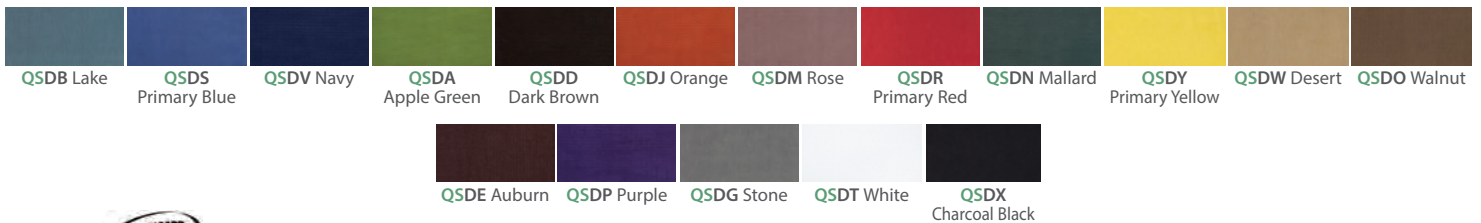

Royal Vinyls

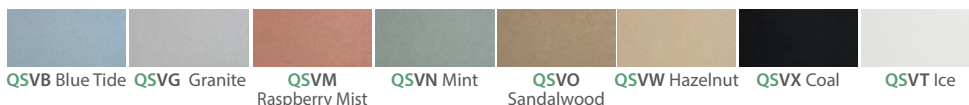

Fabrics Treated with Scotchgard™ Fabric Protector





NEW! SCREENFLEX OFFICEFLEX PRE-CONFIGURED CUBICLES



Quickly enhance the privacy in your office workspace with Officeflex Cubicles. These lightweight cubicle panels arrive pre-configured in three different options – Corner, to add privacy on two sides; Single for one workstation; and Double, for two work stations side by side or facing each other – to help customize your space to your business needs. These panels are designed with sound-absorbing properties to minimize noise distractions and can help increase productivity. For small businesses, call centers, insurance agencies, or any other facility needing modern and tackable workstations, Officeflex offers a cost-effective solution.

FEATURES

- Panel size is 6'W x 6'H
- Lightweight yet sturdy, black aluminum frame
- Optional window customization
- Available in Corner, Single and Double configurations
- Tackable fabric options for display purposes
- Easy, no tool assembly

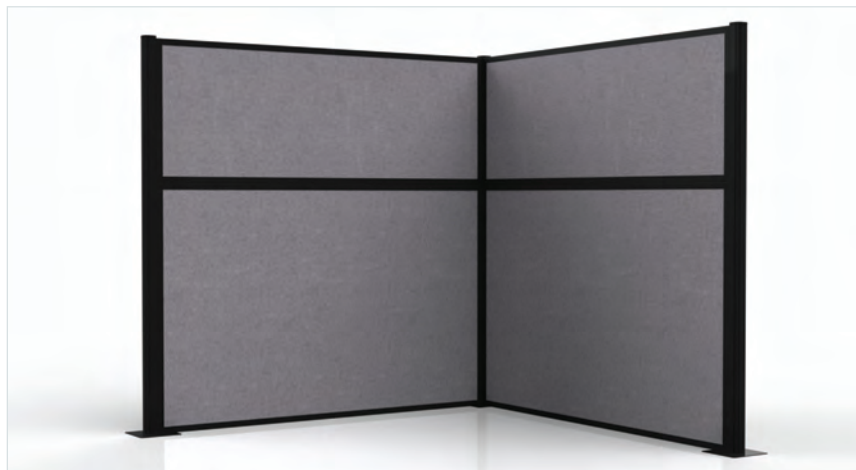

Configuration Type	List Price
Corner	\$1,790.00
Single	\$2,645.00
Double	\$4,355.00

Upholstery Colors

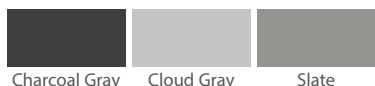



AKT



Akt Lounge Soft Seating - Both physical and mental health are extremely important to Gen Z. Since Mooreco serves across multi-channels, we took some healthcare soft seating principles and applied them into Akt Soft Seating. The sturdy construction of the frame includes an engineered webbing suspension, and seats are made of high density foam.

Akt Lounge Tables - With sophistication and sleek style, Akt Lounge Tables are an ideal addition to individual work areas, collaborative spaces, or other team environments. Available in three sizes: single, loveseat, or sofa width. Customizable with your choice of laminates and edge bands. Includes black powder-coated steel frame.



Akt Soft Seating		
A	SOAKLO298718	Akt Lounge Sofa 31"H x 87"W x 29½"D
B	SOAKLO293818	Akt Lounge Chair 31"H x 39"W x 29½"D
C	SOAKAL295418	Akt Lounge Loveseat 31"H x 54"W x 29½"D
D	SOAKBN292918	Akt Lounge Single Bench 17"H x 29½"W x 29½"D
E	SOAKCO292918	Akt Lounge Corner Chair 31"H x 29½"W x 29½"D
Akt Lounge Tables		
F	SOAKTB292910	Akt Lounge Single Table 10"H x 29½"W x 29½"D
G	SOAKTB294510	Akt Lounge Loveseat Table 10"H x 54"W x 29½"D
H	SOAKTB297810	Akt Lounge Sofa Table 10"H x 78"W x 29½"D

SO = SPECIAL ORDER

Please contact us for details, lead times & pricing.



AKT



Akt Seating - Akt 4-leg chairs also come with glides or casters. Choose the caster chair to cultivate an active environment that takes work on-the-go. Stacking stools and chairs can stack up to ten high, promoting balance, and the glides include a metal stem that pushes in to keep them in place, unlike other manufacturers.

Akt Tables - Akt tables are a reconfigurable solution designed for dynamic and collaborative environments. Tables may be used for group work emphasizing team activities and socialization. They can also be used alone with plenty of space to spread out and get creative. Ideally suited for secondary learners, higher education students, and employees in the workforce.

Elate Task Chair - Elate Task Chairs are a stylish and ergonomic option for maximizing comfort at your office place or classroom.

Available Laminate Finishes

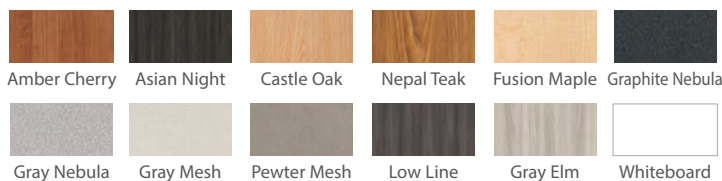

Available In Six Colors

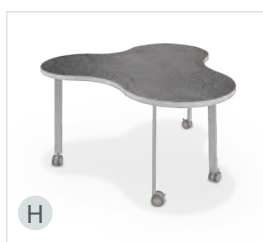
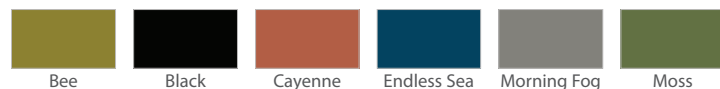

Akt Seating		
A	SO56577	Akt Stacking Chair 30"H x 20"W x 22½"D
B	SO56579HC	Akt 4 Leg Chair - Hard Caster 30"H x 20"W x 22½"D
C	SO56579GL	Akt 4 Leg Chair - Glide 30"H x 20"W x 22½"D
D	SO56581HC	Akt 5 Star Chair - Hard Caster 29-34"H x 27½"W x 27½"D
Akt Tables		
E	SOSDAF29R	Akt Table - Racetrack 29"H x 72"W x 30"D
F	SOSDAX29R	Akt Table - Cog 29"H x 64¾"W x 56½"D
G	SOSDAJ42F	Akt Table - Square 42"H x 48"W x 48"D
H	SOSDAQ29R	Akt Table - Amoeba 29"H x 48"W x 48"D
Elate Seating		
I	SO56584V	Elate Task Chair 39½- 41½"H x 24¾"W x 24¾"D

SO = SPECIAL ORDER

Please contact us for details, lead times & pricing.

UL 1-HOUR LATERAL FILES

UL 1-Hour Class. Products undergo exhaustive testing procedures passing fire hazard tests which expose the file to temperatures of 1700 degrees for one hour resulting in the internal temperature not exceeding 350 degrees. File folders not included. Manufacturer limited lifetime warranty. **Free After-Fire Replacement Guarantee.**

Available in Standard Finish: **QSParchment**



Shown in **QSParchment**

A 4 Drawer File - Letter/Legal

QS43122C*
31³/₁₆"W x 22¹/₈"D x 52³/₄"H
Weight: 794 lbs.
List: \$8,492.00

B 4 Drawer File - Letter/Legal

QS43822C*
37¹/₂"W x 22¹/₈"D x 52³/₄"H
Weight: 907 lbs.
List: \$10,134.00

C 4 Drawer File - Letter/Legal

QS44422C*
44¹/₂"W x 22¹/₈"D x 52³/₄"H
Weight: 1,019 lbs.
List: \$12,179.00

Note: 2 & 3 drawer files also available.

QS = QUICKSHIP



Pictured in **SOLight Walnut**



Need Help With The Heavy Lifting? - FireKing White Glove Delivery Service
Please Call Your Local Sales Rep For Details!

UL 1-HOUR VERTICAL FILES

UL-1 Hour Class 350 Fire Rating. While the main focus of FireKing®'s classic vertical filing cabinets is their fire rated design, they are also attractive and functional, making them an ideal asset to your home or business. This design makes each drawer a separate insulated container. FireKing® offers an asbestos-free, dry insulation. Product is equipped with UL listed high-security Medeco® locks. Manufacturer's limited lifetime warranty. **Free After-Fire Replacement Guarantee.**

31¹/₂" - DEEP FILES

A 2 Drawer File - Legal

QS22131C
20³/₄"W x 31¹/₁₆"D x 27³/₄"H
Weight: 383 lbs.
List: \$4,409.00

B 4 Drawer File - Legal

QS42131C*
20³/₄"W x 31¹/₁₆"D x 52³/₄"H
Weight: 664 lbs.
List: \$6,713.00

C 2 Drawer File - Letter

QS21831C
17³/₄"W x 31¹/₁₆"D x 27³/₄"H
Weight: 348 lbs.
List: \$4,287.00

D 4 Drawer File - Letter

QS41831C*
17³/₄"W x 31¹/₁₆"D x 52³/₄"H
Weight: 603 lbs.
List: \$6,539.00



Shown in **QSParchment**

Shown in **QSBlack**

Special Order Designer Finishes
Additional fees for designer finishes - Call for more details

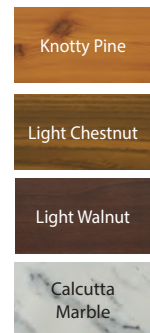

SO = SPECIAL ORDER

25" - DEEP FILES

E 2 Drawer File - Letter

QS21825C
17³/₄"W x 25"D x 27³/₄"H
Weight: 287 lbs.
List: \$3,452.00

F 4 Drawer File - Letter

QS41825C
17³/₄"W x 25"D x 52³/₄"H
Weight: 508 lbs.
List: \$5,397.00

G 2 Drawer File - Legal

QS22125C
20³/₄"W x 25"D x 27³/₄"H
Weight: 326 lbs.
List: \$3,512.00

H 4 Drawer File - Legal

QS42125C*
20³/₄"W x 25"D x 52³/₄"H
Weight: 551 lbs.
List: \$5,489.00

Available in Standard Finishes: **QSParchment** & **QSBlack**

QS = QUICKSHIP



*Note: Drop shipping required for all files over 550 lbs. Shipping will need to be quoted.

UL 1-HOUR TURTLE FILES

Each and every highly-durable fire rated file cabinet has been meticulously designed and tested to offer the highest quality asset protection, coupled with flexible filing capabilities for your most important legal or letter-sized documents. Two person delivery required. File folders not included. Manufacturer limited lifetime warranty.



Pictured in QSParchment



A 2 Drawer File - Letter/Legal
QS2R1822C
 17¾"W x 22⅞"D x 27¾"H
 Weight: 251 lbs.
 List: \$1,953.00



B 4 Drawer File - Letter/Legal
QS4R1822C
 17¾"W x 22⅞"D x 52¾"H
 Weight: 435 lbs.
 List: \$3,375.00



Available in Standard Finish: **QSParchment**, **QSBlack** & **QSArctic White**

Need Help With The Heavy Lifting?
FireKing White Glove Delivery Service
Please Call Your Local Sales Rep For Details!

1-HOUR FIRE RESISTANT STORAGE CABINETS

FireKing®'s durable Fire Rated Storage Cabinets with adjustable shelves are designed specifically to protect your oversized documents, binders, end-tab filing and other invaluable items. Each and every cabinet is manufactured in the USA and comes with a UL 1-Hour Class 350 Fire Rating.



A Storage Cabinet
QSCF7236D*
 36"W x 19¼"D x 72"H
 Weight: 892 lbs.
 List: \$8,736.00

Storage Cabinet
QSCF4436D*
 36"W x 19¼"D x 44"H
 Weight: 620 lbs.
 List: \$5,883.00

B Storage Cabinet w/End-Tab Filing
QSCF7236MD*
 36"W x 19¼"D x 72"H
 Weight: 948 lbs.
 List: \$10,371.00

Storage Cabinet w/End-Tab Filing
QSCF4436MD*
 36"W x 19¼"D x 44"H
 Weight: 698 lbs.
 List: \$6,673.00

Available in Standard Finish: **QSParchment**



*Note: Drop shipping required for all files over 550 lbs. Shipping will need to be quoted.

Please contact us for details & lead times. Pricing subject to change.

OFFICESOURCE®

Adeley	149	Integrate	134	Reese	156
Advanced	188	Interchangeable.....	151, 178-179	Refined	8-9
Advantage	209	Jola	152, 166	Remington.....	145
Aero	157	Julep.....	165	Riveted.....	26-27
Arc.....	199	Keyboard Systems	232-233	Ridge	200
Artesa.....	190	Kinsley	150	Rise Stool	169
Artisan.....	14-15	Laminate Components	34-39	Robust.....	131
Bedford	29	Laminate Cubbies	224	Round	150
Bell	173	Laminate Reception	82-83	Rowland	4-5, 114
Benching Cabinet	221	Laminate Typicals	30-33, 40-59	Ryde	210
Big & Tall.....	210-215	Lancaster	206	Safeguard.....	95-97
Blow Mold	132, 155	Lateral Files	220-221	Serene	194
Bolster	150	Levy	163	Sienna	18-19
Bookcases.....	218-219	Lucca	16-17	Sierra	208
Borders II.....	88-94	Madison	139	Slash.....	160
Bowery.....	148	Manhattan	138	Spencer.....	149, 207
Boxero	204	Mario	158	Spice.....	170, 189
Bradley.....	198	Markle	6-7	Stacked Seating	161
Cade	190	Medical Stools.....	173	StandUp Components.....	76-79
Carson	163	Melamine Tables	133	StandUp Typicals	80-81
Chair Accessories.....	217	Merak.....	201	Steel Folding Chairs	155
Chair Functions.....	216	Merit.....	154	Steel Storage Cabinets.....	223
Chair Mats	234-237	Metal Open Hanging Storage....	225	Sterling	140
Charleston	207	Modular Electric Systems	227	Stockton	11
Chelsea	147	Monitor Arms	228	Sofia	127
Color Stack.....	168	Millennial	136	Storage Cabinets & Wardrobes...	222
Conference Tables.....	112-114	Mira.....	144	Studio.....	204
Contour	208	Monroe	10	Task Force.....	172
CoolMesh	184-187	Multi-Purpose.....	115-126	Task Lighting	229
CoolMesh Basic.....	186	Obsidian	205	Tate.....	151
CoolMesh Pro	171, 182-183	Orion	174-175	Technology	230-233
Cosmo	85-87	Oslo.....	170, 176-177	Tower	160
Costa	181	OS Panels	98-101	Training Tables	104-111
Crossway.....	162, 191	Palisades.....	20-23, 84, 114, 130	Tre	202
Crusader	189	Palma	180	Tre Lite.....	203
C-Table.....	128	Palmer	12	Tribeca.....	137
Define	141	Parallel.....	130	Triumph.....	165
Dover	146	Partridge.....	142-143	Value.....	154
Draper	135	Parson	162	Variant Components.....	60-66
Ebony.....	151	Pedestal Tables.....	128	Variant Typicals.....	67-75
Effort	172	Pedestals.....	224-225	Veneto.....	196-197
Empire.....	195	Pennington	194	Vertical Files.....	226
Engage.....	181	Perch	164	ViZual.....	102-103
Epitome.....	24-25	Plexus.....	194	Westwood	13
Framed	140	Prestige	199	Whitley	29
Franklin	192-193	Provident	208	Willow	153, 167
Heavy Duty Wire Racks	219	Raleigh.....	28	Wire Management.....	229
		Reception Tables	129	Zella	159

MODERN *Versatility*



 **OfficeSource**
FURNITURE

LUCCA

Experience unparalleled flexibility and Impeccable style. The Lucca collection offers an array of desk, storage, and conference solutions meticulously crafted to meet your every need. Select from a duo of captivating, two-toned finishes, and redefine your workspace with sophistication and versatility.



INTRODUCING AMERICAN ELM

Transcend
THE ORDINARY



DISCOVER THE EPITOME OF STYLE AND FUNCTIONALITY
WITH THE OS LAMINATE COLLECTION.

This exceptional line offers a wide array of components and sizes, allowing you to effortlessly customize your workspace to meet your every need. Elevate your workplace to new heights, where creativity thrives, and productivity soars.