

2024 CATALOG

PRODUCT SOLUTIONS | ENGINEERING EXCELLENCE | SIGNATURE SERVICE



"Furniture for every element"



CAFETERIA



SCIENCE LAB



MUSIC ROOM



AUDITORIUM



National Public Seating

ESTABLISHED
1981

• 44 YEARS •



**Industrial
Grade Product
Solutions**



**Built with
Engineering
Excellence**



**Signature
Service**

NPS outfits industries across the country with no-fail equipment they use every single day.

In 1981 Oklahoma Sound opened its doors, recognizing an unmet need in the furniture industry. Podiums that worked well and lasted for years. We sought to build cabinetry that would perform through decades of wear and tear, pieces designed with schools, worship centers, and organizations in mind. And so, with a few helping hands, we got to work manufacturing every element of the furniture in house. That's right, not just the cabinetry, but the speakers and amplifiers were built from scratch. It seemed the best way to take real ownership of the end product.

The results were powerful and organizations came back asking for more. Chairs, this time. The team obliged, and in 1997 National Public Seating was born. Now, NPS outfits spaces across the country with no-fail furniture they use every single day. From ultra-breathable flex chairs to easy-expand tables on wheels, our products are innovative, solution-focused, and both durable and comfortable to the nth degree. We ship them out quickly because we know time is of the essence, and we do everything possible to give you, our customers, a smooth experience from first purchase to years down the line.



A PASSION FOR EDUCATION



Furnishing schools is our passion. Of course, we love providing every industry with the tools it needs to succeed, but sustaining the learning and development of America's future leaders is where we shine brightest. Students sit most of the day. If they aren't comfortable they'll fidget and won't be happy to learn. It's that basic. That's why making strong, feel-good furniture for schools is our focal point. We proudly equip art rooms, music rooms, science labs, auditoriums, and cafeterias with sturdy tables, supportive chairs, and hardwood lecterns designed to truly last.

INDUSTRIAL GRADE



All our products are industrial grade, and that means they're crafted for heavy-duty usage day in, day out. We don't cut corners and we don't mess around. Our team of engineers and designers develop the furniture in our New Jersey plant, supported by 90+ factory employees. The furniture is then put through rigorous quality control testing to ensure it meets and surpasses every industry standard. We are there at every step in the manufacturing process.

SIGNATURE SERVICE



Our sales team doesn't rest on its laurels. It is constantly finding new ways to better streamline the supply process. The shipping team gets orders on the road in hours, and with warehouses in California, Tennessee and New Jersey, shipments often arrive the next day. Believe it or not, our customer service representatives look forward to solving any issue that should crop up. Because that's what they're there for. That's not all, though. Thanks to our custom design services, reliable web support, no-questions-asked returns and repairs, and ten year warranty, our dealers have come to know and deeply trust our service for 40 years. Here's to many more!



**HAND SKETCH
CONCEPT**

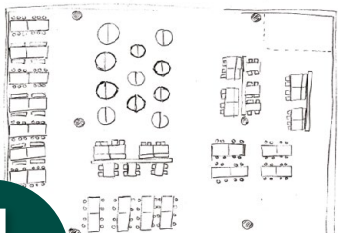

**NPS 2D
DRAWING**

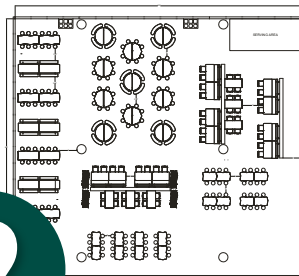

**NPS 3D
RENDERING**

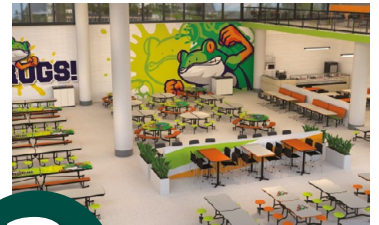

1

2

3



NPS DESIGN SERVICES

You think it. **We create it.**

Our products are featured on leading design software



2024 NEW PRODUCTS

Heavy Duty Designer Tables

HDTD Series

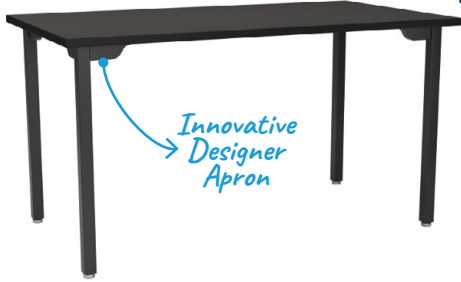

Options Available



See More at Page 68

Heavy Duty Activity Tables

HDTA Series

Trapezoid



Square



Hexa



Round



Semicircle



Tri



6 Shapes!



See More at Page 72

Robotics Bumper Kit

TBK Series



Tool-Free Setup!



See More at Page 78

Hexagon Workstation

WSH Series



Options Available



See More at Page 94



See More
at Page 149

**2 DAY
LIGHTNING SHIP**

Tuba Rest

TR82



See More
at Page 18

**2 DAY
LIGHTNING SHIP**

Airflex® Series

Model 1412

*New
Platinum
Color!*



See More
at Page 25

**2 DAY
LIGHTNING SHIP**

Cafetorium Stools | New Colors!

Available in
Counter and
Bar Heights



Comfort Task Chair & Stool



Conductor's Furniture



ErgoMax Stool



Titan Tables & Stools



Max Seating™ Series



**RECENTLY
LAUNCHED
PRODUCTS**

LuvraFlex Series
Stack Chairs



**2 DAY
LIGHTNING SHIP**

Mobile Science Cabinets
MSC Series

5 Models
Available



**7 DAY
QUICK SHIP**

Cluster Swivel Booth
Comfort | Design | Performance



Sit Stand Pro
SSDG-20

**2 DAY
LIGHTNING SHIP**



TABLE OF CONTENTS

12 FOLDING CHAIRS



22 STACK CHAIRS



34 STOOLS



64 HEAVY DUTY TABLES



84 MOBILE SCIENCE CARTS



95 HEXAGON WORKSTATIONS



139 CAFÉ



148 MUSIC



156 ROOM DIVIDERS

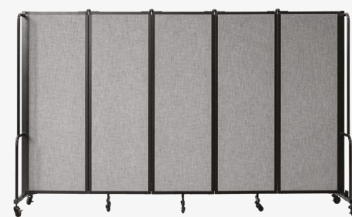

184 SOUND LECTERNS



191 PRESENTATION CARTS



194 CHARGING CARTS



195 PA SYSTEMS



199 BASICS BY NPS

BASICS
by NPS

202 DESIGN OPTIONS



46 PLASTIC FOLDING TABLES



56 WOOD FOLDING TABLES



62 TITAN TABLES



98 SCIENCE TABLES



106 WORKSTATIONS



112 MOBILE TABLES



140 STAGES & RISERS

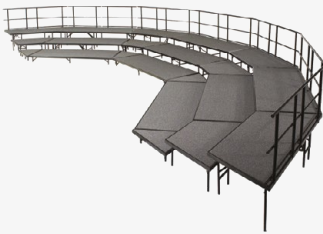

169 DOLLIES



178 LECTERNS



Quickship Available
For Most Products



State and Regional
Government Contracts



Online Dealer Support

- Price Lists
- Assembly Instructions
- Freight Quotes
- Service Portal
- Order Tracking



Offering TAA Compliant Products



Online Image Library



Parts under \$25
Ship to End Users with No Charge



Expansive Online Product Videos



Now offering full design services!



Our entire product line is MAS Certified Green®.
For more information, visit www.mascertifiedgreen.com



GENERAL PRODUCTS



MOBILE TABLES



BASICS BY NPS







FOLDING CHAIRS

Steel Chairs

50, 200, 300,
5200



Upholstered Chairs

1200, 1300, 2200,
2300, 3200



Plastic Chairs

600, 800,
1100, 1400



All-Steel

Standard | Double Brace | Single Hinge | 19-Gauge Frame
50 Series



Premium | Double Brace | Double Hinge | 18-Gauge Frame
200 Series



TAA ✓



Colors



Beige
51



Grey
52



Black
510

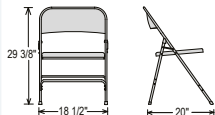

Colors



Beige
201



Grey
202



Brown
203



Char-Blue
204



Black
210



Red
240

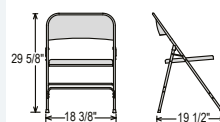

Shared Features

Available Accessories



PGC1

Ganging Device for Models
50 · 200 · 300 · 800 · 1100
· 1200 · 1300 · 2200 · 2300
· 3200 · 5200



MGC

Ganging Device for Models
50 · 200 · 300 · 800 · 1100
· 1200 · 1300 · 2200 · 2300
· 3200



GL

Glides for Models
50 · 200 · 300 · 800 · 1100 ·
1200 · 1300 · 2200 · 2300 ·
3200 · 5200



VT

V-Tips for Models
50 · 200 · 300 · 800 · 1100 ·
1200 · 1300 · 2200 · 2300 ·
3200 · 5200

**THE
Body
Builder
LINE**

Premium | Triple-Brace | Double Hinge | 18-Gauge Frame
300 Series



Premium All-Steel with Tablet Arm | Double Hinge
5200 Series



TAA ✓

2 DAY LIGHTNING SHIP

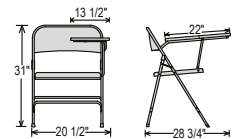

Colors

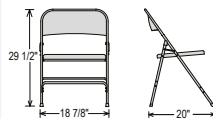

Colors



Features



Extended Tablet Provides Extra Writing Space



Ultra-Strong Triangular Gorilla Bracket Adds Superior Durability

*5200 Cannot Be Transported on Dollies

Shared Features

All Steel Features



Non-Marring Replaceable Glides That Match Frame Color



Back Leg Stability Plugs



Double Riveted U Brace



2 1/4" Frame Strengthener



Vinyl Upholstered

Double Brace | Double Hinge
1200 Series



Triple U Brace | Double Hinge
1300 Series



TAA ✓



Colors



French Beige Vinyl
Beige Frame
1201 / 1301



Warm Grey Vinyl
Grey Frame
1202 / 1302



Dark Midnight Blue Vinyl
Char-Blue Frame
1204 / 1304



Caviar Black Vinyl
Black Frame
1210 / 1310



Honey Brown Vinyl
Beige Frame
1203

Shared Features

Vinyl and Fabric Features



Non-Marring
Replaceable Glides That
Match Frame Color



Back Leg
Stability
Plugs



Double
Riveted U
Brace



2 1/4" Frame
Strengthener



Upholstered
Seat and Back



Double Hinge

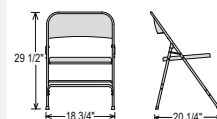

Double Brace | Double Hinge
 2200 Series



Triple U Brace | Double Hinge
 2300 Series



Colors



Cafe Beige Fabric
 Beige Frame
 2201 / 2301



Greystone Fabric
 Grey Frame
 2202 / 2302



Russet Walnut Fabric
 Brown Frame
 2207

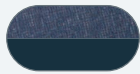

Imperial Blue Fabric
 Char-Blue Frame
 2204 / 2304



Midnight Black Fabric
 Black Frame
 2210 / 2310



Majestic Cabernet Fabric
 Grey Frame
 2208/2308



Imperial Blue Fabric
 Grey Frame
 2205

Shared Features

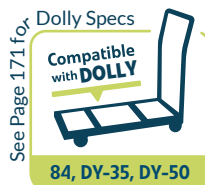

products meet or exceed applicable ANSI/BIFMA standards



Folding Chairs

2" Upholstered Fabric/Vinyl Seat 3200 Series



Blow Molded 600 Series



Fabric Colors



Charcoal Grey Fabric
Black Frame
3212

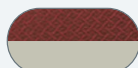

New Burgundy Fabric
Grey Frame
3218

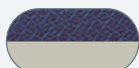

Regal Blue Fabric
Grey Frame
3215

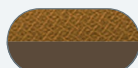

Antique Gold Fabric
Brown Frame
3219

Vinyl Colors



Beige Vinyl
Beige Frame
3201



Black Vinyl
Black Frame
3210

Colors

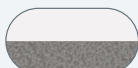

Speckled Grey Plastic
Grey Hammer Tone Frame
602



Blue Plastic
Black Frame
604



Black Plastic
Black Frame
610

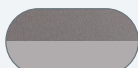

Charcoal Slate Plastic
Silvertone Frame
620



Red Plastic
Black Frame
640

Features



2" Ultra Comfort
Box Seat



High Backrest

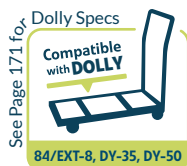
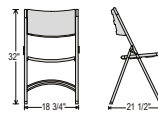
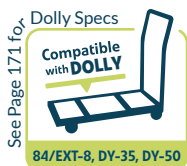
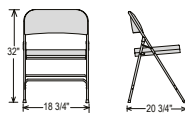

Features



19-Gauge
Steel Frame



Fully Welded
U Brace

**Premium Plastic Lightweight
800 Series**



**SUPER
STACKER**

**2 DAY
LIGHTNING SHIP**

**Polyfold Fan Back Triple-Trace
1100 Series**



**SUPER
STACKER**

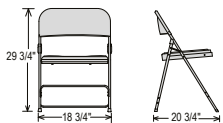

TAA ✓

See Page 171 for Dolly Specs
Compatible with **DOLLY**
84, DY700/800,
DY-35, DY-50

Colors

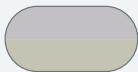

Grey Plastic
Grey Frame
802



Blue Plastic
Grey Frame
805



Black Plastic
Black Frame
810



Burgundy Plastic
Black Frame
818

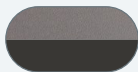

Charcoal Slate Plastic
Black Frame
820



White Plastic
White Frame
821

**CAL-133
RATED**

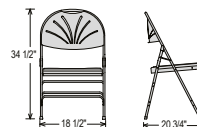

See Page 171 for Dolly Specs
Compatible with **DOLLY**
84/EXT-8, DY35,
DY-50, DY1100

Colors



Blue Plastic
Grey Frame
1105



Black Plastic
Black Frame
1110



Dark Blue Plastic
Grey Frame
1115

Features



18-Gauge
Steel Frame



Double Riveted
U Brace



7/8" Round
Tubular Frame



Non-Marring
Polypropylene Glides



Double Hinge

See Available
Accessories on
PAGE 12



ten year
warranty
10

**BIFMA
INTERNATIONAL
ANSI**

products meet
or exceed applicable
ANSI/BIFMA standards

AirFlex®



COMFORT

Distinct AirFlex® Design
Contours to Each Individual
Making for the Perfect Balance
of Comfort and Strength.



DESIGN

Modern Design
Enhances Any Event.



DURABILITY

Strong 18-Gauge Steel Frame
and Seat Supports Make for
Long Lasting Durability.



Features



Durable Industrial Grade 3.8MM Polypropylene



Seat Strengthened With Two 11-Gauge Steel Side Supports



Sweat-Free Ventilation



18-Gauge Steel Frame



7/8" Square Leg Tubing for Added Strength



Oversized 18"D Seat



Backrest Secured With Rivets

Colors



Black
1410



Platinum
1412



White
1421

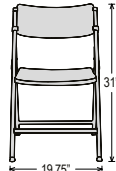

AirFlex® Dimensions
Overall: 31" H x 19.75" W x 20.25" D
Folded: 40.25" H x 19.50" W x 2" D
Seat: 17.25" H x 17" W x 18" D
Back: 7.5" H x 19.5" W
Weight: 9.6 lbs.



products meet or exceed applicable ANSI/BIFMA standards





STACK CHAIRS



Stack Chairs

8100, 8500, 8600, 8700,
8800, LuvraFlex

Polyshell Stacker
8100 Series



Stacks
10
CHAIRS



See Page 173 for

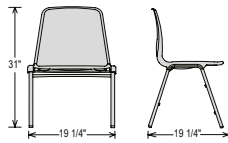

Features



High-Density Injection Molded Poly One-Piece Shell



Frame Shields Protect Against Snags and Pinching



Strong 17-Gauge 7/8" Square Tubing

Colors

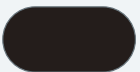

Black
8110



Blue
8125



Available Accessories



TA81R*
Oak Surface
Left Tablet Arm



TA81R*
Oak Surface
Right Tablet Arm



PGC81
Ganging Device

*Chairs can't be stacked with tablet arms attached

Signature Stacker
8600 Series



Stacks
20
CHAIRS

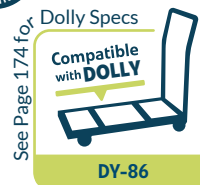

See Page 174 for

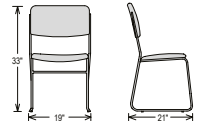

Features



Strong 16-Gauge 1/2" Round Tubing



Contoured Seat and Back for Enhanced Comfort



Non-Marring Floor Glides

Colors



Ebony Black
8660



Classic Grey
8652

Accessories



MGC86
Ganging Device



products meet or exceed applicable ANSI/BIFMA standards



Black Frame / Black Fabric Also Available as Custom Order for 8600

Hi Tech Ultra Compact Stacker
8500 Series



Features



Molded Seat and Back Provide Comfort and Allow for Easy Interstacking



Protective Rounded Polycarbonate Floor Glides With Custom Clamping Device



Reinforced Underseat Ribbing for Added Strength



Chrome-Plated 11mm Steel Rod Frame

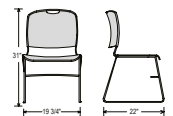

products meet or exceed applicable ANSI/BIFMA standards



Colors

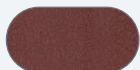

Wine
8508



Black
8510



Gunmetal Grey
8502



Navy Blue
8505

Available Accessories



TA85L*
Black Left
Tablet Arm



TA85R*
Black Right
Tablet Arm

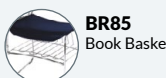

BR85
Book Basket



PGC85
Ganging Device

*Chairs can't be stacked with tablet arms attached



See Page 173 for

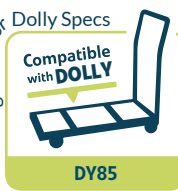

STACK CHAIRS | 8700 SERIES
Padded Cafetorium Chair



See Page 27 for Custom Color Options

Standard Colors

8704-10-04
 Blue Poly and Blue Vinyl
 Black Frame

8710-11-10
 Black Poly and Black Vinyl
 Chrome Frame

8742-12-02
 Grey Poly and Blue Vinyl
 Silver Frame



24" SEAT HEIGHT

See Page 27 for Custom Color Options

Standard Colors

8710C-11-10
 Black Poly and Black Vinyl
 Chrome Frame



30" SEAT HEIGHT

See Page 27 for Custom Color Options

Standard Colors

8710B-11-10
 Black Poly and Black Vinyl
 Chrome Frame

Chair Features 8700/8800



"Rod In Tube"
 Design



Glides Function as
 Built-in Gangers for
 Multi Chair Setup



Polypropylene Plastic
 Back Design Provides
 Ergonomic Support



Glides Are Made
 of TPU For
 Sensitive Floors

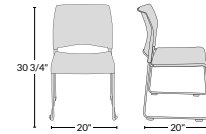

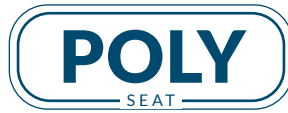

STACK CHAIRS | 8800 SERIES Poly Cafetorium Chair



See Page 27 for Custom Color Options



24" SEAT HEIGHT

See Page 27 for Custom Color Options



30" SEAT HEIGHT

See Page 27 for Custom Color Options

Standard Colors

- 8804-11-04 Blue Poly Chrome Frame
- 8810-11-10 Black Poly Chrome Frame
- 8820-11-20 Charcoal Poly Chrome Frame

Standard Colors

- 8804C-11-04 Blue Poly Chrome Frame **NEW**
- 8810C-11-10 Black Poly Chrome Frame
- 8820C-11-20 Charcoal Poly Chrome Frame **NEW**

Standard Colors

- 8804B-11-04 Blue Poly Chrome Frame **NEW**
- 8810B-11-10 Black Poly Chrome Frame
- 8820B-11-20 Charcoal Poly Chrome Frame **NEW**

Bar Stool Features 8700/8800

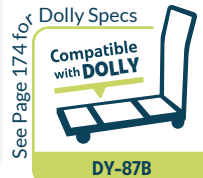
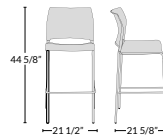



Features



Solid Rod Frame Design



Transparent Glides Feature a Felt Base for Floor Protection



Flex Back Tested by SGS Labs to Resist 425 Lbs of Force



Unique Design for Ultimate Seating Comfort



Glides Function as Built-in Gangers for Multi Chair Setup



See Facing Page for Custom Color Options

Standard Poly Colors



LVC04-10
Blue Poly
Black Frame



LVC10-11
Black Poly
Chrome Frame



LVC20-11
Charcoal Poly
Chrome Frame

See Facing Page for Custom Color Options

Standard Vinyl Colors

add vinyl code to the end of poly chair model number



04
Blue



10
Black

Model Number Configuration

Poly Chair Model Number

LVC04-10-10

Vinyl Seat Color (if applicable)



products meet or exceed applicable ANSI/BIFMA standards



8700/8800/LuvraFlex Custom Colors

Custom Color Options

300 Chair MOQ and Extended Lead Times Apply

Frame Colors

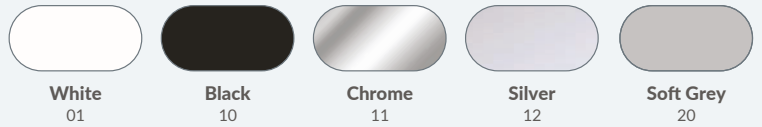

Available for 8700/8800 and LuvraFlex

Poly



Available for 8700 and LuvraFlex

Vinyl

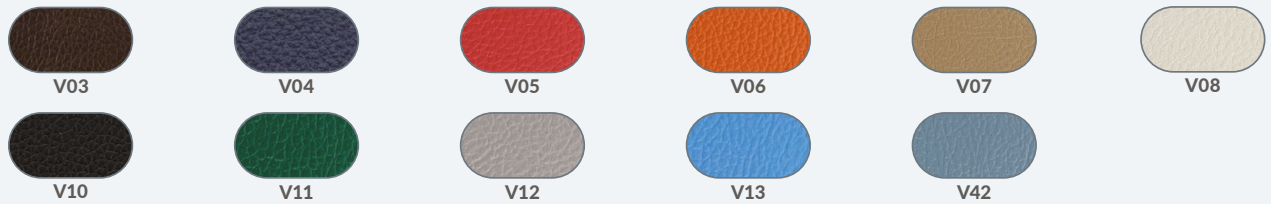

Available for 8700 and LuvraFlex

Fabric



8700/8800 Custom Configuration

Model Number Frame Color
87* PXX-XX-PXX
 Seat Color Back Color

*Add B for Bar Height or C for Counter Height



LuvraFlex Custom Configuration

Model Number Frame Color
LVC PXX-XX-VXX
 Poly Color Vinyl/Fabric Seat Color (if applicable)

BANQUET CHAIRS



Banquet Chairs

Dome Back 9200 Series



Silhouette Back 9300 Series



Stacks
10
CHAIRS

See Page 173 for Dolly Specs

Compatible with DOLLY

DY81, DY-9000



Standard Colors

See Page 206 for Custom Color Options



9254-SV
Midnight Blue Fabric
Silvervein Frame



9201-M
French Beige Vinyl
Mocha Frame



9254-BT
Midnight Blue Fabric
Black Santex Frame



9204-SV
Midnight Blue Vinyl
Silvervein Frame



9260-SV
Ebony Black Fabric
Silvervein Frame



9204-BT
Midnight Blue Vinyl
Black Santex Frame



9260-BT
Ebony Black Fabric
Black Santex Frame



9210-SV
Panther Black Vinyl
Silvervein Frame



9210-BT
Panther Black Vinyl
Black Santex Frame

Standard Colors

See Page 206 for Custom Color Options



9304-SV
Midnight Blue Vinyl
Silvervein Frame



9362-BT
Natural Greystone Fabric
Black Santex Frame



9310-BT
Panther Black Vinyl
Black Santex Frame



9364-SV
Diamond Navy Fabric
Silvervein Frame



9354-SV
Midnight Blue Fabric
Silvervein Frame



9374-BT
Natural Blue Fabric
Black Santex Frame



9360-BT
Ebony Black Fabric
Black Santex Frame



9378-BT
Natural Taupe Fabric
Black Santex Frame



9361-BT
Natural Chocolatier Fabric
Black Santex Frame

Features



2" 1.8lb. High-Density Grade A Foam Waterfall Seat

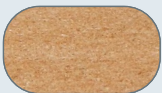

MDF Core Seat and Back



Stacking Bars And 12 Plastic Stack Bumpers Ensure Stacking Securely



7/8" Square 18 Gauge Tubing With Non-Marring Glides 5/8" Underseat H Braces

9200



Back Rests On 4 Tabs For Extra Durability

9300



Premium Double Back Conceals 4 Steel Backrest Tabs

CAL-117
RATED

ten year warranty
10

BIFMA
INTERNATIONAL

ANSI

products meet or exceed applicable ANSI/BIFMA standards

GREEN
CERTIFIED
GREEN

MOBILE CHAIRS



MOBILE CHAIRS | COGO SERIES
CoGo Mobile Tablet Chair
 Modern chair for today's collaborative learning!



DESIGN

Ergonomically Designed For All-Day Seating Support; Contemporary Design Enhances the Modern Classroom.



MOBILITY

Allows Students to Move to Different Learning Areas With Ease.



DURABILITY

16 Gauge Steel and Twin 2 Inch Casters for Long-Lasting Classroom Use.



products meet or exceed applicable ANSI/BIFMA standards



Features



Strong Twin Wheeled 2" Casters



Fiberglass-Reinforced Polypropylene



Tablet Can Be Installed on the Right or Left Side

Seat Colors



Black
COGO-10



Blue
COGO-04



Red
COGO-40

Available Accessory



GLCOGO
Set of Four Glides



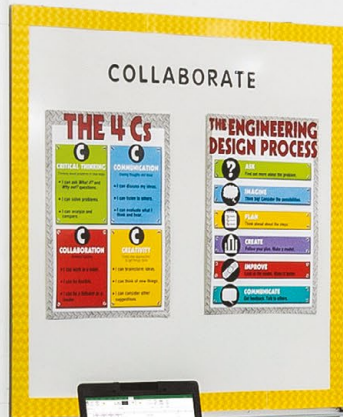

STOOLS



Stools
6200, 6300,
6400, 6500



**Designer
Stools**
6600, 6800,
Titan



**Task Chairs
and Stools**
6700, CTC



Heavy-Duty Masonite Seat Stools

Features



8 Rivets on Seat To Ensure Longevity



Heavy-Duty 18-Gauge 7/8" Steel Tubing



Industrial Grade Glides



Four Weld Points at Each Leg for Extreme Durability



Add-on Backrest Adjusts 2" Up/Down and 2" Forward/Back



Add-on Chromed Adjustable Height Inserts Adjust to Nine Heights



STANDARD



BACKREST



ADJUSTABLE HEIGHT



ADJUSTABLE HEIGHT & BACKREST



Model # Seat Height

6218	18"
6224	24"
6230	30"
6218H	19-27"
6224H	25-33"
6230H	32-39"

Model Number Configuration



Frame Colors

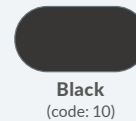

Seat Color



Add-on Codes

Backrest	B
Adjustable Height	H
Adjustable Height and Backrest	HB

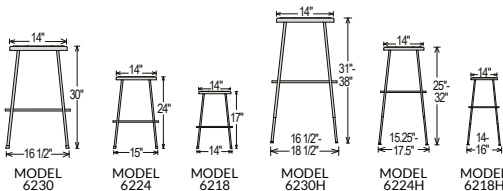

Heavy-Duty Masonite Seat Stools

Features



16 Rivets on Seat To Ensure Longevity



Four Weld Points at Each Leg for Extreme Durability



Industrial Grade Glides



Heavy-Duty 18-Gauge 7/8" Steel Tubing



Add-on Backrest Adjusts 2" Up/Down and 2" Forward/Back



Add-on Chromed Adjustable Height Inserts Adjust to Nine Heights



STANDARD



BACKREST



ADJUSTABLE HEIGHT



ADJUSTABLE HEIGHT & BACKREST



Model # Seat Height

6318	18"
6324	24"
6330	30"
6318H	19-27"
6324H	25-33"
6330H	32-39"

Model Number Configuration

Model Number Add-on Code (if applicable)
6318H

Frame Colors



Grey

Seat Color

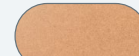

Masonite

Add-on Codes

Backrest	B
Adjustable Height	H
Adjustable Height and Backrest	HB

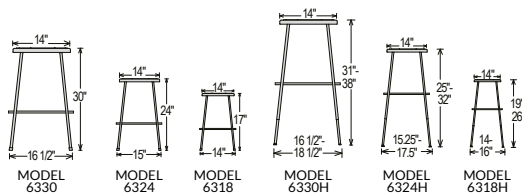

Heavy-Duty Padded Stools

Features

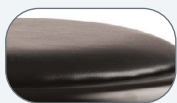

Padded Vinyl Seat



Heavy-Duty 18-Gauge 7/8" Steel Tubing



Industrial Grade Glides

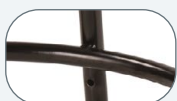

Four Weld Points at Each Leg for Extreme Durability

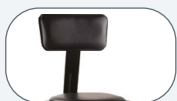

Add-on Backrest Adjusts 2" Up/Down and 2" Forward/Back



Add-on Chromed Adjustable Height Inserts Adjust to Nine Heights



STANDARD



BACKREST



ADJUSTABLE HEIGHT



ADJUSTABLE HEIGHT & BACKREST



Model # Seat Height

6418	18"
6424	24"
6430	30"
6418H	19-27"
6424H	25-33"
6430H	32-39"

Model Number Configuration



Stool Colors



Grey Vinyl
Grey Frame
(no code)



Black Vinyl
Black Frame
(code: 10)



Add-on Codes

Backrest	B
Adjustable Height	H
Adjustable Height and Backrest	HB

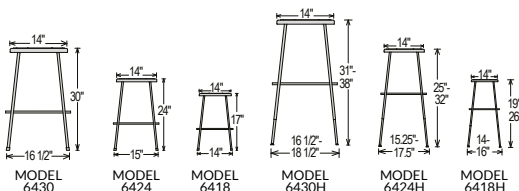

products meet or exceed applicable ANSI/BIFMA standards

STOOLS | 6500 SERIES
Heavy-Duty Padded Stools

Features



Height Adjustable from 24"-30"



1/2" Vinyl Padded Riveted Thru the Steel Seat Pan



7/8" O.D. 16-Gauge Steel Tubing



Foot Rings, 5/8" O.D. Welded to Each Leg



Add-on Backrest Adjusts 2" Up/Down and 2" Forward/Back



Stool Color

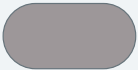

Grey

Model #	Height	Description
6524HB	24-30"	Stool with Backrest
6524H	24-30"	Stool without Backrest

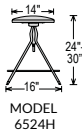
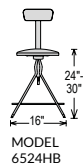

The Contemporary Designer Stool

Soft Seat

Metallic grey or black base with a 3" stain resistant fabric and a Solid Pine core.

Soft Seat Height Adjustable from 18" – 25"



Steel Seat

Metallic grey or black base and heavyduty steel seatpan with an aesthetically pleasing polypropylene plastic surface available in an array of colors.

Metal Seat Height Adjustable from 18" – 24"



Wooden Seat

Metallic grey or black base and a robust 1.2" thick solid New Zealand pine wood seat with a clear lacquer finishing

Wood Seat Height Adjustable from 19" – 25"



Seat Colors



Black
(10S)

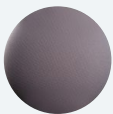

Charcoal
(20S)



Cobalt Blue
(25S)

Seat Colors

All seats are on grey steel



Persian Blue
(25)



Blueberry
(05)



Burgundy
(18)



Black
(10)

Seat Color



New Zealand Pine
(00W)

Features



360° Turning Capability



Non-Marring Glides

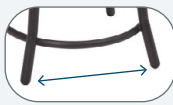

20" Cross Leg Distance



Metal Center Sleeve Conceals Adjustable Height Pole



Seat Adjustable Using the Swivel Mechanism



Built in 4" Height Footrest With a 15" Diameter

Frame Colors



Grey
02

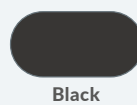

Black
10

Model Number Configuration

Prefix Seat Code
 | |
 | |
68 10-02
 | |
 Frame Color



products meet or exceed applicable ANSI/BIFMA standards



Model Number Configuration

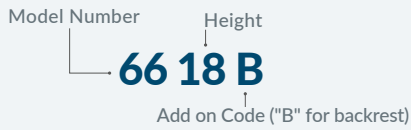

Model # | Seat Height

6618	18"
6622	22"
6624	24"



products meet or exceed applicable ANSI/BIFMA standards

Features



Additional Weld on Bottom for Added Strength



Riveted Glides For Added Stability

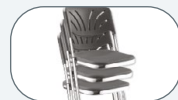

Conveniently Stackable



Optional Fan-Back For Extra Comfort



14 Gauge Eye-Tubular Steel Frame



Nests on Tabletops For Easy Cleanup and Storage!



Ergonomic Blow Molded Seat Provides Maximum Comfort



Embedded Thermoplastic Polyurethane TPU Glides Provide Quiet and Smooth Gliding On All Floor Types



Oversized Contact Area For Extreme Stability



Rear Brace For Added Strength



Built in 4" Height Footrest With a 15" Diameter

6622/6624

TITAN STOOL





Steel Seat



Black Poly Center
Soft Grey Steel
S10



Wood Seat



Solid Oak
1.2" Thick
BB



Laminate Seat

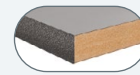

MDF with Protect Edge
HPL Surface | 1.2" Thick
MDPExx*



Particleboard with T-Mold
HPL Surface | 1.2" Thick
PBTMxx*

PAGE 203 | Laminate, and Edge Options

*Specify Laminate Code in place of xx

STANDARD



BACKREST



ADJUSTABLE HEIGHT



ADJUSTABLE HEIGHT & BACKREST



Features



Curved Footring for
Extra Leg Support



14-Gauge
Steel Tubing



Industrial Grade
Glides



Full Welds at Each
Leg for Extreme
Durability



Heavy-Duty Steel
Backrest With
Double Locking
Mechanism



Add-on Adjustable
Height Inserts Adjust
to Nine Heights



Model #	Seat Height
TTSG18	18"
TTSG24	24"
TTSG30	30"
TTSG18H	18-26"
TTSG24H	24-32"
TTSG30H	30-38"

Add-on Codes	
Backrest	B
Adjustable Height	H
Adjustable Height and Backrest	HB

Model Number Configuration

Model Number Add-on Code (if applicable)
TTSG 18H BB
 Height Seat Code

Frame Color



products meet
or exceed applicable
ANSI/BIFMA standards

Comfort Task Chair and Stool

Comfort Task Stool



Comfort Task Chair



TAA ✓

2 DAY
LIGHTNING SHIP

Fabric tested to
EXCEED 70,000
double rubs

WEIGHT CAPACITY
300 lbs

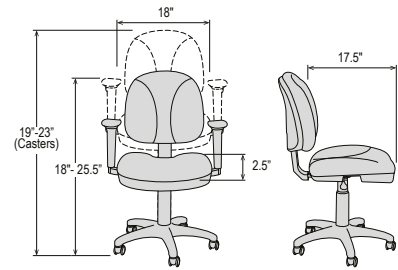
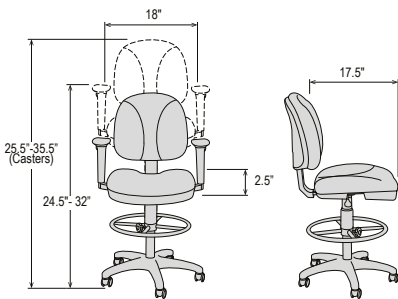

Features

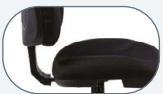

Plush Padded Seat
And Back



Includes Five 2"
Industrial Grade Casters
and Mushroom Glides



Plastic Reinforced
Backrest and Seat

Add-On



Optional Armrest With
11 Adjustable Heights,
Including Lowest Position
(½ Inch Increments)

Model # Description

CTC	18"-22" (Glides) 19"-23" (Casters) Comfort Task Chair
CTC-A	18"-22" (Glides) 19"-23" (Casters) Comfort Task Chair with Adjustable Height Armrests
CTS	24.5"-34.5" (Glides) 25.5"-35.5" (Casters) Comfort Task Stool
CTS-A	24.5"-34.5" (Glides) 25.5"-35.5" (Casters) Comfort Task Stool with Adjustable Height Armrests

CAL-117
RATED

MADE
CERTIFIED GREEN
For a healthier and safer environment

ten year
warranty
10

BIFMA
INTERNATIONAL
ANSI

products meet
or exceed applicable
ANSI/BIFMA standards

Polyurethane Task Chair



Polyurethane Task Stool



**2 DAY
 LIGHTNING SHIP**



Features



Convenient Backrest Handhold for Maneuverability



Includes Five 2" Industrial Grade Casters and Mushroom Glides



Backrest Tilt

Add-On



Optional Armrest with 11 Adjustable Heights, Including Lowest at 1/2 Inch Increments

Model #	Description
6716HB	16"-21" Polyurethane Chair (desk height)
6722HB	22"-32" Polyurethane Stool
6716HB-A	16"-21" Polyurethane Chair (desk height) with Adjustable Height Armrests
6722HB-A	22"-32" Polyurethane Stool with Adjustable Height Armrests



products meet or exceed applicable ANSI/BIFMA standards





PLASTIC FOLDING TABLES

**Plastic
Folding Tables**
1800, 2400, 3000, 3600,
BTA, BTR, BMFIH, BPFT



PLASTIC FOLDING TABLES | 1800 SERIES

Seminar Tables



The perfect solution for your banquet & cafeteria use – indoor, outdoor, or any other application that calls for affordable, lightweight, weather resistant and highly durable folding tables.



THREE SIZES AVAILABLE



Model #	Size
BT1860	18"x60"
BT1872	18"x72"
BT1896	18"x96"

Colors

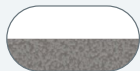

Speckled Grey Plastic
Grey Hammer Tone
Frame

Features



Unique Spring-Loaded Lock For Complete Stability



2" Thick UV Protected Tabletop

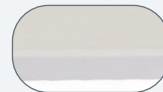

Textured Tabletop Surface Smooth Enough For Writing



Industrial Grade Framing System



16-Gauge Cantilever Comfort Legs

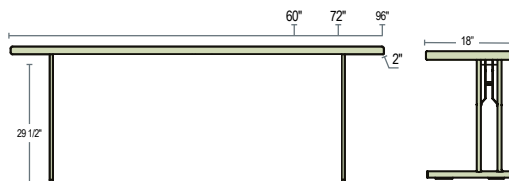

evenly distributed



products meet or exceed applicable ANSI/BIFMA standards

Blow Molded Folding Tables

See Page 169 for Dolly Specs
Compatible with **DOLLY**
TAD, DYMU



Features



17-Gauge Framing System



Built In Handle For Easy Lifting



Extra Stable Gravity Lock

Colors

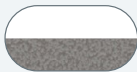

Speckled Grey Plastic
Grey Hammer Tone Frame

Model Number
BT2448

can withstand heat up to **212°**

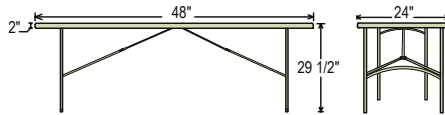

evenly distributed



products meet or exceed applicable ANSI/BIFMA standards



Features



19-Gauge Framing System



Attractive Arched Tube Leg Connectors For Added Strength

can withstand heat up to **212°**

Model Number
BT3636

Colors



Speckled Grey Plastic
Grey Hammer Tone Frame

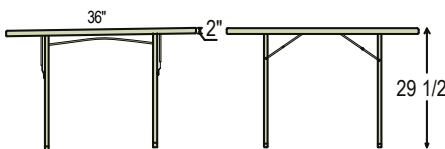

evenly distributed



products meet or exceed applicable ANSI/BIFMA standards



PLASTIC FOLDING TABLES | BT3000 SERIE
Blow Molding Folding Tables



See Page 169 for Dolly Specs
 Compatible with DOLLY
 TAD, DYMU, DY3072/DY3096



BT3072-20



Features



18-Gauge Legs



17-Gauge Framing System



Heavy Duty Wishbone Leg Structure



Extra Stable Gravity Lock

Colors



BT3000 series
 Speckled Grey Plastic
 Grey Hammer Tone Frame



BT3072-20 series
 Charcoal Slate Plastic
 Silverstone Frame (30"x72" only)

Model #	Size
BT3060	30"x60"
BT3072*	30"x72"
BT3096	30"x96"

*add -20 for Charcoal Slate

THREE SIZES AVAILABLE

can withstand heat up to **212°**

2 DAY LIGHTNING SHIP

BT3060/BT3072



evenly distributed

BT3096



evenly distributed



products meet or exceed applicable ANSI/BIFMA standards

PLASTIC FOLDING TABLES | BTA SERIES
Adjustable Folding Tables

Brighten up your room to create a complete portable Furniture Suite, with these attractive, affordable, Quick Ship Tables!



Features



Lightweight 37lbs For Easy Setup and Transport



Adjustable Height From 22-28.5"

Colors



BTA-3072-40
Red Plastic
Black Frame



BTA-3072-04
Blue Plastic
Black Frame

See Page 169 for Dolly Specs
Compatible with DOLLY
TAD, DYMU, DY3072/DY3096

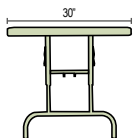
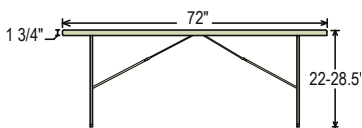

evenly distributed



products meet or exceed applicable ANSI/BIFMA standards

Round Folding Tables



The perfect solution for your banquet & cafeteria use – indoor, outdoor, or any other application that calls for affordable, lightweight, weather resistant and highly durable folding tables.



See Page 170 for Dolly Specs
Compatible with **DOLLY**
DY-60R, DY-71R, DYMU

2 DAY LIGHTNING SHIP

can withstand heat up to **212°**

Features

All Round Tables		BT48R/BT71R		BT60R	
	Gravity Lock		2" Thick UV Protected Tabletop		19-Gauge Framing System
	700 LBS Weight Capacity		17-Gauge Framing System		1000 LBS Weight Capacity

Colors

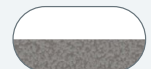

Speckled Grey Plastic
Grey Hammer Tone Frame

Model #	Size
BT48R	48"
BT60R	60"
BT71R	71"

THREE SIZES AVAILABLE

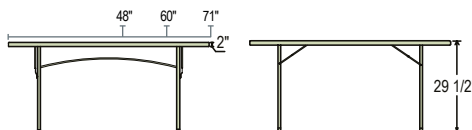

ten year warranty
10



PLASTIC FOLDING TABLES | BMFIH SERIES
Fold in Half Tables



Features



Automatic Locking Device for Safe Setup



1.5" High-Density Polyethylene (HDPE) Top



Gravity Lock



First of Its Kind! Rounded Ends and Oblique Edges.



No Cross Bar Allows For Additional Seating At The End Of The Table



Powder-Coated 19-Gauge Steel Frame



Convenient Carrying Handle for Easy Transport



Lightweight 37lbs for Easy Setup and Transport

Colors



Speckled Grey Plastic
 Grey Hammer Tone Frame



Open dimensions:
 71.8"L x 30"W x 29.5"H
 Folded dimensions:
 36"L x 30"W x 3.75"D

Model Number
BMFIH3072

can withstand heat up to
212°

2 DAY LIGHTNING SHIP



evenly distributed



products meet or exceed applicable ANSIBIFMA standards

PLASTIC FOLDING TABLES | BPFT SERIES

Flip-N-Store



Model Number Configuration

Model Number Color (if applicable)

BPFT-24 **60-20**

Length

TWO SIZES AVAILABLE

24" Standard Width

Lengths

60"

72"

Colors

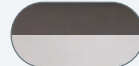

Charcoal Slate Top
Silvertone Frame
(code: 20)

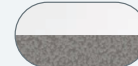

Speckled Grey Top
Grey Frame
(no code)



Roll In



Flip



Store



Features



Frame and Legs Are Made With Industrial Grade Powdercoated Steel



Perforated Steel Modesty Panel With a Built-in Cable Channel To Conceal Wires



Four 2" Casters (Two Locking) Enable Tables to Roll With Ease



Lightweight 37lbs for Easy Setup and Transport



Two Grommet Holes for Wire Management



Tables Nest for Easy Storage



Use Lever to Collapse Tables for Easy Storage



17-Gauge Steel Frame



evenly distributed



products meet or exceed applicable ANSI/BIFMA standards





MAX Seating™
MSFT



Flip-Top
TGT



WOOD FOLDING TABLES

MAX Seating Tables™

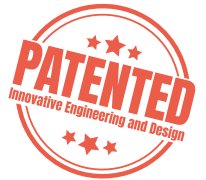

Features



16-Gauge C-Channel Frame



2-Point Welded Leg Brace



14-Gauge 1.25" Square Leg Tubing Legs



Proprietary Leg Clips Secure Legs When Folded



Auto-Engage Locking Mechanism

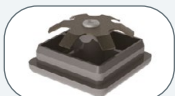

High-Impact, Non-Marring Spring Steel Flower Glides



Folding/Locking Mechanisms Exceeded 7,000 Cycle Tests



Legs at Table Corners for Max Seating™



Nylon Corners With Standoff for Scratch-Free Stackability



14-Gauge Stability Boost Leg Brackets



Leg Design Options

*Use leg code MSFE for 30" high elevated standard legs



29"H | Standard*
(MSFT)



29"H | Cantilever
(MSFTC)

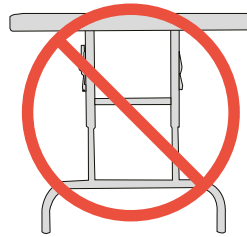

**NO WISHBONE LEGS
 FOR ZERO OBSTRUCTION
 MAX SEATING™ SPACE**

Tabletops

Custom tabletop core and surfaces available

PAGE 203 | Laminate and Edge Design Options



Particleboard with T-Molding
 .75" Core | HPL Surface
 T-molding
 (PB TM)



Particleboard with 3mm PVC Edge
 .75" Core | HPL Surface
 3mm Hot-Melt PVC Edge
 (PB EB)

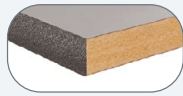

MDF with Protect Edge
 .75" Core | HPL Surface
 Protect Edge
 (MD PE)



Plywood with T-Molding
 .75" Core | HPL Surface
 T-molding
 (PW TM)

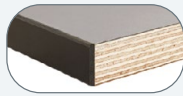

Plywood with 3mm PVC Edge
 .75" Core | HPL Surface
 3mm Hot-Melt PVC Edge
 (PW EB)

Standard Leg Placement

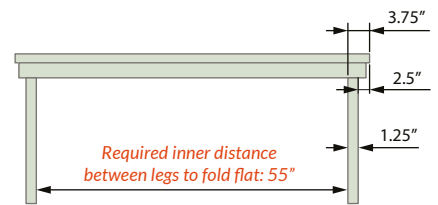

Size (width/Length in inches)

1848*	1860	1872	1884	1896
2448*	2460	2472	2484	2496
3048*	3060	3072	3084	3096
3648*	3660	3672	3684	3696
48RD	60RD	72RD	RD= Round	

● Available in Cantilever Leg

*48" Long Rectangle Tables Do Not Fold Flat

See Next Page for Custom Sizes and Recessed Leg Options

Model Number Configuration

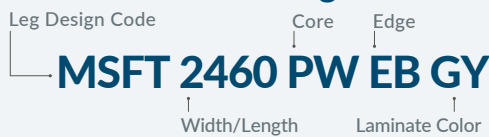

7 Day Quickship Models:

- MSFT1872PMDPECE (Carbon EV)
- MSFT1872PMDPEPN (Pinnacle Walnut)
- MSFTC1872PMDPECE (Carbon EV)
- MSFTC1872PMDPEPN (Pinnacle Walnut)
- MSFT1896PMDPECE (Carbon EV)
- MSFT1896PMDPEPN (Pinnacle Walnut)
- MSFTC1896PMDPECE (Carbon EV)
- MSFTC1896PMDPEPN (Pinnacle Walnut)



Compact Wood Folding Bench

Same Heavy Duty structure as MAX Seating Tables



Model Number Configuration

Prefix
MSFB 1572 PW EB GY
 Core Edge
 Width/Length Laminate Color

Sizes

- 15"x60"
- 15"x72"
- 15"x96"



Tabletops

Custom tabletop core and surfaces available



MDF with Protect Edge
 .75" Core | HPL Surface
 Protect Edge (MD PE)



Particleboard with T-Molding
 .75" Core | HPL Surface
 T-molding (PB TM)

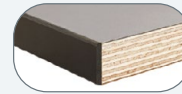

Plywood with 3mm PVC Edge
 .75" Core | HPL Surface
 3mm Hot-Melt PVC Edge (PW EB)

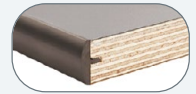

Plywood with T-Molding
 .75" Core | HPL Surface
 T-molding (PW TM)

PAGE 203 | Laminate and Edge Design Options

Custom Size Tables:

Upcharge and extended lead time apply

We can build any length tabletop on the smaller size frame (up to 108" long). We will install it onto the closest smaller size frame (60", 72", 84" & 96" Length).

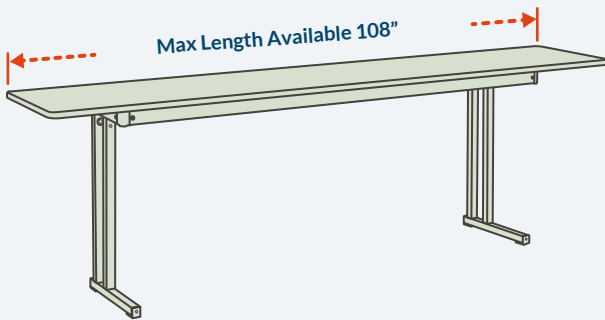

Recessed Legs:

*Available only for rectangle shape | Upcharge and extended lead time apply

Table legs can be recessed to your ideal placement to help maximize seating space. When recessing legs, only the legs for which a dimension is noted will be recessed. Any non-specified legs will be mounted at the standard placement.

To recess the right leg:

Add **R** followed by distance from the edge of the tabletop at the end of model number (i.e. R12)

To recess the left leg:

Add **L** followed by distance from the edge of the tabletop at the end of model number (i.e. L8)

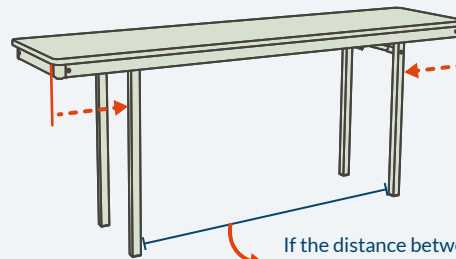

If the distance between legs is less than 58" Table Will Not Fold Flat



Model Number Configuration

Custom Length
MSFT 24108 PW EB GY

Model Number Configuration

Right Leg Recessed Distance from Edge
MSFT 2448 PW EB GY R12 L8
 Left Leg Recessed Distance from Edge



Please note:

- All testing was conducted with standard tabletop and leg configurations. Recessing legs or customizing tabletops may cause table to be susceptible to tipping.
- Please allow up to 2 inch tolerance.

WOODEN FOLDING TABLES | TGT SERIES
Flip Top Table



 PAGE 203 | Laminate and Edge Design Options

Features



Heavy Duty 3" Locking Casters



14-Gauge Steel Frame



Auto Lock System



Tables Flip and Nest for Simple Storage

Table Core/Edge Options

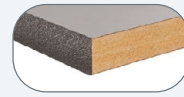

1.2" MDF Core
 HPL Surface
 Protect Edge (MDPE)



1.2" Particleboard Core
 HPL Surface
 T-Mold (PBTM)

Model Number Configuration

Model Number Core Edge
TGT 2448 MD PE GY
 Width/Length Laminate Color

Model #	Seats	Table WxL	Table-Seat Height (Standard)
TGT2448	2-3	24"x48"	24"x48"
TGT2460	3-4	24"x60"	24"x60"
TGT3048	2-3	30"x48"	30"x48"
TGT3060	3-4	30"x60"	30"x60"

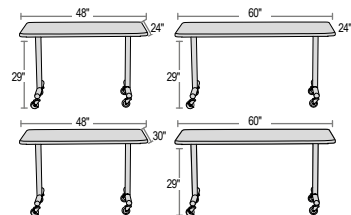



5/8
Prüf Tech work for you in
"Hekt"
personal again!
Tablets vs HW in Lintel 2011
Interaction w/ your dog
data - Efficiency, Time!
Blended reality - Global safety
Teamwork - Accessibility

5/8/15
Prüf Tech work for
"Hekt"
personal again!
Tablets vs HW in Lintel
Interaction w/ your
data - Efficiency, Time!
Blended reality



STEELTABLES

Titan
TT



Heavy Duty
HDT, HDTD, HDTA



Heavy Duty Accessories
TRAY-KIT, TBK



Titan Table



Features



14-Gauge Legs Are Set at a 94 Degree Angle



Tamper-Free Hardware



Super-Duty Sheet-Metal Apron Design



Undertable Hat Structure for Ultimate Durability



Legs Are Fastened With a Double Bolt and Four Screw Connection



6 Millimeter Thick Foot Plate for Extreme Strength



Tables Ship With Frame Pre-Installed



Apron Is Constructed from 14-Gauge Steel

THREE HEIGHTS AVAILABLE

Frame Color



Titan Table

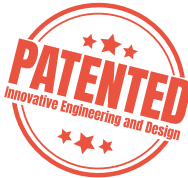

Heights



Model Number Configuration

Prefix Casters/Glides Top
TT02-2448 G 1 PBTM GY
 Width/Length Height Laminate Color (if applicable)

Table Foot Options



4" Lock Casters
 Constructed with Polyamide Plus TPU Tread (C)



Super-Duty Steel Glides
 Powercoated Grey Felt base rubber foot (G)

Size (Width/Length in inches)

2436	2442	2448	2454	2460	2472	2484	2496
3036	3042	3048	3054	3060	3072	3084	3096
3636	3642	3648	3654	3660	3672	3684	3696
4242	4248	4254	4260	4272	4284	4296	
4848	4854	4860	4872	4884	4896		

- Quick ship tables available, choose from tops B, W, C, P
- Quick ship tables available, choose from tops P and C
- Quick ship tables available with top C only

Standard lead time is 8 weeks. Quick ship lead time is 7 days.

Tabletops



High Pressure Laminate

1.2" particleboard core
 HPL Surface | T-molding (PBTM)

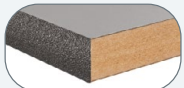

High Pressure Laminate

1.2" MDF core
 HPL Surface | Protect Edge (MDPE)



Whiteboard

1.2" Particleboard Core
 Markerboard HPL Surface | PVC Edge Banding (W)



Chem-Res

1" Particleboard Core
 Chemical Resistant Top
 Edge Banding (C)



Phenolic

.75" Solid Phenolic
 Designer Beveled Edges (P)



Trespa

.75" Cellulose Core
 Designer Beveled Edges (T)



Butcherblock

1.75" Solid Maple Wood
 Proprietary UV Finish (B)

See page 207 for warranty, finish options and care instructions.

PAGE 203 | Laminate and Edge Design Options



products meet or exceed applicable ANSIBIFMA standards



STEEL TABLES | HDT SERIES
Heavy Duty Tables





MORE THAN
2,000
DESIGN VARIATIONS

Heavy Duty Tables Specs

Tabletops



Standard High Pressure Laminate
 .75" particleboard core
 HPL Surface | T-molding
 (H)

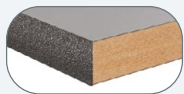

Supreme High Pressure Laminate
 1.2" MDF core
 HPL Surface | Protect Edge
 (S)



Whiteboard
 1.2" Particleboard Core
 Markerboard HPL Surface
 | PVC Edge Banding
 (W)



Chem-Res
 1" Particleboard Core
 Chemical Resistant Top
 Edge Banding
 (C)



Phenolic
 .75" Solid Phenolic
 Designer Beveled Edges
 (P)

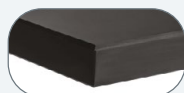

Trespa
 .75" Cellulose Core
 Designer Beveled Edges
 (T)



Epoxy
 1" Solid Epoxy
 Designer Beveled Edges
 (E)



Butcherblock
 1.75" Solid Maple Wood
 Proprietary UV Finish
 (B)

See page 207 for warranty, finish options and care instructions.

PAGE 203 | Laminate and Edge Design Options

The **NPS Heavy Duty Table** is ideal for any makerspace environment. The 16-Gauge apron and 14-Gauge legs make this table virtually indestructible. Available with either fixed or adjustable height legs. Adjustable legs can be raised in 1" increments and are locked firmly in place with 2 K-9 external tooth lock washers and heavy duty tamper-free hex screws. All legs come standard with simple-adjust glides and have a caster option for easy mobility. **Play. Work. Study.**

Table Sizes

*Personal sizes
 patent pending
 18"x24", 18"x30",
 24"x24", 24"x30",
 30"x30"*

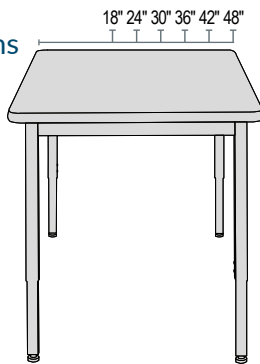

Length Options

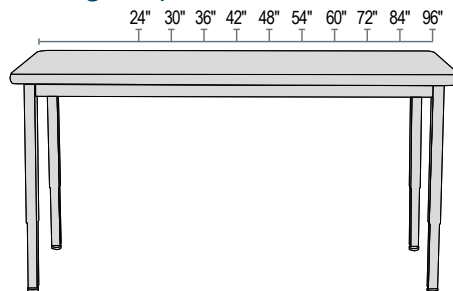

Leg Construction

Fixed Height Legs:



Adjustable Height Legs:



Standard Features



Corner Brackets Bolted Onto Frame



Dual-Side Leg Connection



Welded 12-Gauge Leg Top Plate



Adjustable Legs Adjust in 1" Increments



11-Gauge Welded Support Brackets



16-Gauge Channel Frame



Leveling Glides Can Add up to 3/4" Height to Table



Exceeds 500lbs. Static Weight Capacity

Optional Accessories

Casters

3" Heavy-Duty Casters



- 4 Heavy Duty Swivel Locking Casters
- Increases the Table Height by 3¼"
- A Set of Gussets Is Included With Casters

Corner Gussets



- 13-Gauge Steel
- Tamper-Free Hardware
- All tables wider than 30", longer than 72" will include a set of gussets
- Recommended When Using Tables Above 30" High

Peg Boards

Available for 24" and 30" Tables



- Two 16-Gauge Industrial Grade Peg Boards Included in Each Set
- Variety Set of 50 7-Gauge Chromed Pegs Included With Each Peg Board Set
- Holes Spaced 1" Apart
- Assembled With Tamper-Free Self-Tapping Screws



Model Number Configuration

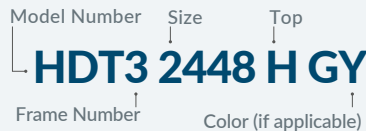

All tables wider than 30", longer than 72", or with Epoxy/Trespa tabletops will include a set of gussets

Accessories Model Number Configuration

Core Model #

CAST-3

Frame #

Model# Description

Model#	Description
CAST-	4 heavy duty casters and gusset
PEG24-	2 Peg boards with 50 Pegs for 24"W Tables
PEG30-	2 Peg boards with 50 Pegs for 30"W Tables

(for example, "3" should be used for accessories used for table frame # HDT3)

Frame# Description

Frame#	Description
HDT3	Heavy Duty Table, Height Adjustable, Textured Black
HDT7	Heavy Duty Table, Fixed Height Legs, Textured Black
HDT8	Heavy Duty Table, Height Adjustable, Soft Grey
HDT9	Heavy Duty Table, Fixed Height Legs, Soft Grey

Size (width/Length in inches)

1824	1830	1836	1842	1848	1854	1860	1872	1884	1896
2424	2430	2436	2442	2448	2454	2460	2472	2484	2496
3030	3036	3042	3048	3054	3060	3072	3084	3096	
3636	3642	3648	3654	3660	3672	3684	3696		
4242	4248	4254	4260	4272	4284	4296			
4848	4854	4860	4872	4884	4896				

- Quick ship tables available, choose from tops B, W, C, P, and H with grey nebula laminate
- Quick ship tables available, choose from tops P and C
- Quick ship tables available with top C only

Standard lead time is 8 weeks. Quick ship lead time is 7 days.

Top Description/edge

Top	Description/edge
B	1.75" Solid Maple Butcherblock/UV Finish
W	1.25" Whiteboard/PVC Edge Banding
H	.75" Standard High Pressure Laminate with T-Mold
S	1.25" Supreme High Pressure Laminate with Protect Edge
C	1" Chem-Res/3mm Edge Banding
P	.75" Solid Phenolic/Beveled Edge
T	.75" Solid Trespa/Beveled Edge
E	1" Solid Epoxy/Beveled Edge

Using Epoxy tables in mobile applications with casters voids the warranty.

Frame Color Options

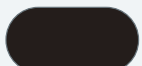

Textured Black



Soft Grey



STEEL TABLES | HDTD SERIES
Heavy Duty Designer Tables



*Heavy-Duty Tables
with a Designer Touch!*





*Innovative
Designer Apron*



Heavy Duty Designer Tables



*Discover the perfect blend of form and function
with our NPS Heavy-Duty Designer Tables!*

MORE THAN 2,000 DESIGN VARIATIONS!



Tabletops



High Pressure Laminate
1.2" particleboard core
HPL Surface | T-molding (H)

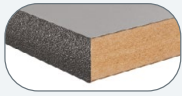

High Pressure Laminate
1.2" MDF core
HPL Surface | Protect Edge (S)



Whiteboard
1.2" Particleboard Core
Markerboard HPL Surface
| PVC Edge Banding (W)



Chem-Res
1" Particleboard Core
Chemical Resistant Top
Edge Banding (C)



Phenolic
.75" Solid Phenolic
Designer Beveled Edges (P)

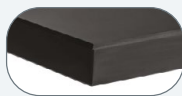

Trespa
.75" Cellulose Core
Designer Beveled Edges (T)



Butcherblock
1.75" Solid Maple Wood
Proprietary UV Finish (B)

See page 207 for warranty, finish options and care instructions.

PAGE 203 | Laminate and Edge Design Options

Standard Features



Innovative Designer Apron



Corner Brackets Bolted Onto Frame

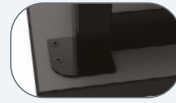

Welded 12-Gauge Leg Top Plate



4-Gauge Full-Length Apron Support Plate



Designer Apron ADA Compliant



Adjustable Legs Adjust in 1" Increments



Leveling Glides Can Add up to 3/4" Height to Table



Exceeds 500lbs. Static Weight Capacity

Frame Color Options

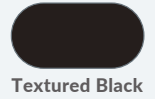

Textured Black



Soft Grey

Table Sizes

Width Options



All Widths/Lengths smaller than 30" feature Standard Non-Designer Aprons

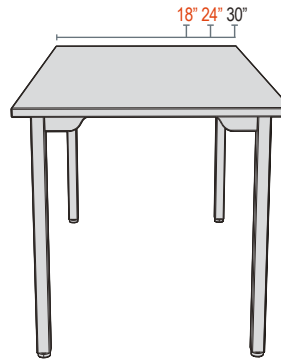

Length Options

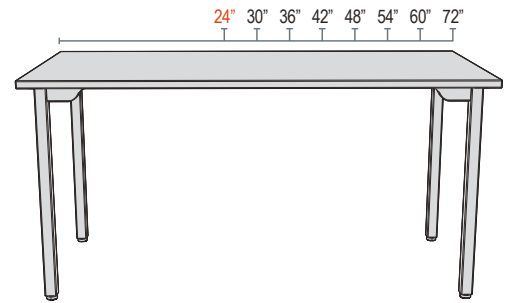

Leg Construction

Fixed Height Legs:

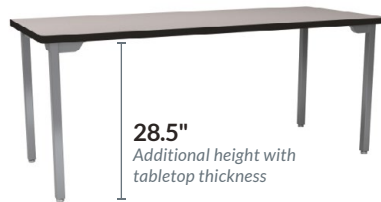

28.5"
Additional height with tabletop thickness

Adjustable Height Legs:

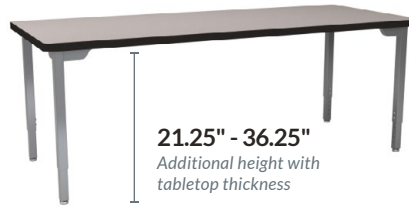

21.25" - 36.25"
Additional height with tabletop thickness

Frame# Description

3	Height Adjustable, Textured Black
7	Fixed Height Legs, Textured Black
8	Height Adjustable, Soft Grey
9	Fixed Height Legs, Soft Grey

Size (width/Length in inches)

1824	1830	1836	1842	1848	1854	1860	1872
2424	2430	2436	2442	2448	2454	2460	2472
3030	3036	3042	3048	3054	3060	3072	

● Quick ship tables available, choose from tops B, W, C, P, and H with grey nebula laminate

● Quick ship tables available, choose from tops P and C

Standard lead time is 8 weeks. Quick ship lead time is 7 days.

Model Number Configuration

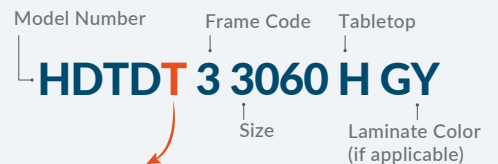

Add "T" here for Pre-Installed Tote Tray Holders
See Page 77 for Tote Tray Holder Specs



STEEL TABLES | HDTA SERIES
Heavy Duty Activity Tables





Classroom Innovation:

*Elevate Learning with Our Dynamic Shape-Shifting
Heavy-Duty Activity Tables!*

Heavy Duty Activity Tables Shapes

TRAPEZOID



SQUARE



ROUND



SEMICIRCLE



HEXA | Designer Shape



TRI | Designer Shape



STEEL TABLES | HDTA SERIES Heavy Duty Activity Table Specs



Exceeds 500lbs.
Static Weight Capacity

Standard Features



Heavy-Duty Activity
11-Gauge Leg Mount



Dual-Side Leg
Connection



Additional
Reinforcement Screws



ADA Compliant



Adjustable Legs
Adjust in 1"
Increments



Patent Pending Leg
Mount Gusset Design



Welded 12-Gauge
Leg Top Plate



Leveling Glides
Can Add up to 3/4"
Height to Table

Tabletops

PAGE 203 | Laminate and Edge Design Options



High Pressure Laminate
1.2" particleboard core
PVC Edge Banding
(PBEB)



High Pressure Laminate
1.2" particleboard core
T-molding
(PBTM)



Whiteboard
1.2" Particleboard Core
Markerboard HPL Surface
PVC Edge Banding
(W)



Chem-Res
1" Particleboard Core
Chemical Resistant Top
Edge Banding
(C)

Leg Construction

Fixed Height Legs:

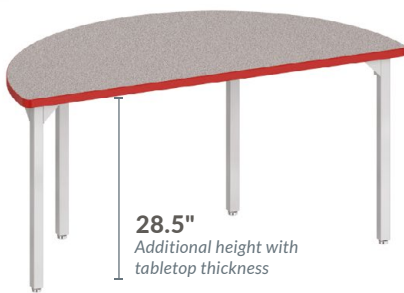

Adjustable Height Legs:

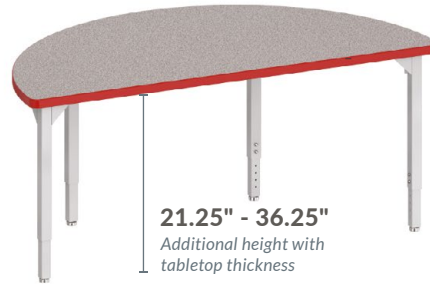

Frame Color Options



Textured Black



Soft Grey

Frame#	Description
3	Height Adjustable, Textured Black
7	Fixed Height Legs, Textured Black
8	Height Adjustable, Soft Grey
9	Fixed Height Legs, Soft Grey

Shapes



Trapezoid
(TZ)



Tri
(TR)



Square
(SQ)



Semicircle
(SC)



Hexa
(HX)



Round
(RD)

Trapezoid Sizes (TZ)

(Width/Length in Inches)

2448 2454 2460 2472
3054 3060 3072

Square Sizes (SQ)

(Width in Inches)

24 30 36 42 48

Hexa Sizes (HX)

(Width/Length in Inches)

2454 2460

Tri Sizes (TR)

(Width/Length in Inches)

2454 2460
3054 3060

Semicircle Sizes (SC)

(Diameter of Full Circle in Inches)

48 60

Round Sizes (RD)

(Diameter in Inches)

36 42 48 60

Model Number Configuration

Model Number Shape Tabletop
HDTA 3 TZ 3060 PBTM GY
 Frame Number Size Laminate Color
 (if applicable)



Tote Tray Holder

Get Tote-ally Organized!

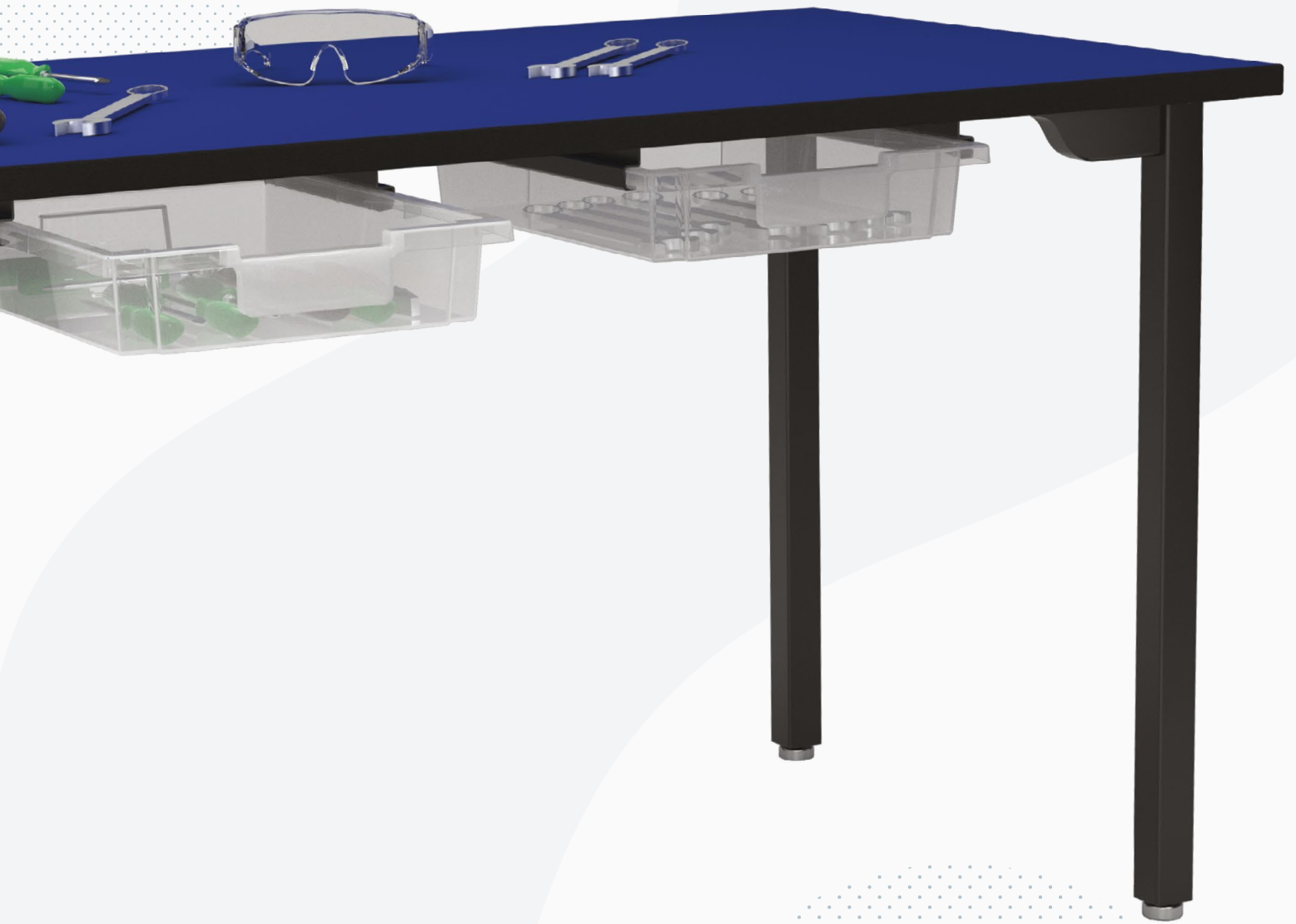

Tote Tray Holder



Tray Holder Dimensions 15.8" L x 12.9" W x 1.7" H
 Available for table 30" and greater

Create an Organized and Inviting Learning Atmosphere with Multishaped Tables and Integrated Tote Tray Holders, Tailored for Educational Excellence

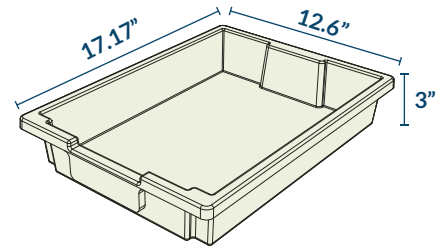

SIMPLE ASSEMBLY TRAY HOLDERS

Compatible Tables: SLT6 Series, HDTD Series, HDTA Series, Titan Series 36" and wider, and CT Series.

Features



Trays are Made of Heavy-Duty Translucent Polypropylene Material



Tray Holders Feature a Single Rail Made of 14-Gauge Steel



Trays Feature Built-In Name Card Slots

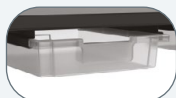

Trays Feature a Built-in Handle and Smooth Edges

Holder Color Options



Textured Black (S10)

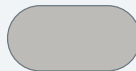

Soft Grey (S02)

Model Number Configuration

Tote Tray Holder Prefix

TRAY-KIT-S10

Tray Holder Color

Perfect Match!

Use with our Mobile Science Cart with Tote Trays MSC04



STEEL TABLES | TBK SERIES
Robotics Bumper Kit



NEW



Discover the future of robotic safety with our versatile and heavy-duty Robotics Bumper Kit! Ideal for all types of robotic environments, this kit can be seamlessly installed on almost any rectangular table, both new and existing.

*Convert any Table into a
 Fun Hub with Our
 Easy-Install Bumper Kit!*



Kit Includes:

- 4 Corner Brackets
- 4 Side Clamps
- 4 Bumper Panels
- 4 Acrylic Foam Corner Protectors



**TOOL FREE
 INSTALLATION**

Personalized for You!

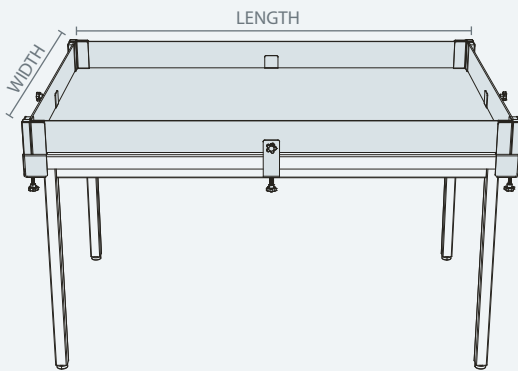

Specify the width and length of your rectangular tabletop for your Bumper Kit preparation, ensuring it is of the same size. Ensure there are no obstructions within 1.5 inches from the edge of the tabletop so that the bumper system can be securely mounted.

Note: Compatible with all NPS Rectangular Tables except SLT6 and MSFT

Standard Features



Simplified Setup with Tool Free Assembly



Compatible with Tabletops up to 1.75" thick

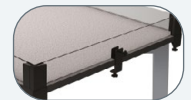

Center Clamps for Ultimate Security

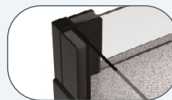

Unique Bumper Style Compatible with Wood or Acrylic Panels



Heavy-Duty Knob Assembly Ensures Unit is Secure when in Use and Allows for Simple Takedown



Corners Brackets and Side Clamps are constructed of 13-Gauge and 6-Gauge Steel Parts

Bumper Type



Optix® Acrylic Bumper
 Clear Acrylic (CA)



Wood Bumper
 Particleboard Core
 HPL Black Surface
 PVC Edge Banding (PBEBBK)

Corners Color

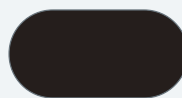

Black Powdercoating

Model Number Configuration

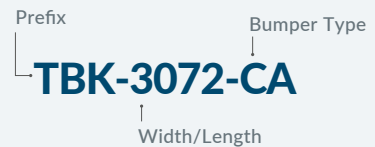



SCIENCE



**Science
Cart**
MSC



**Science
Workstation**
WSH



Science Tables
SLT1, SLT2, SLT3,
SLT7, SLT8, SLT9,
SLTD, SLTA



**Signature
Tables**
SLT4, SLT5



**Designer
Table**
SLT6



MOBILE SCIENCE CARTS



 **SINK OPTION**
for Most Models

 **CUSTOM TOPS**
AVAILABLE

 **HEAVY-DUTY**
CONSTRUCTION

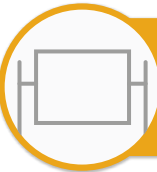

WHITEBOARD/MIRROR
for Most Models

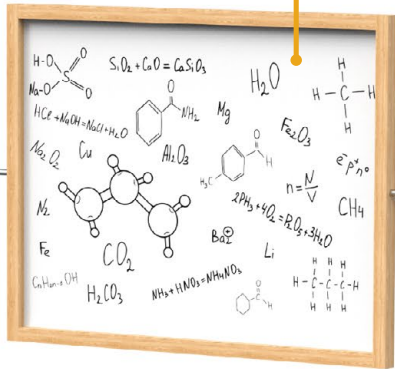

**BUILT-IN
MAGNETIC GANGING**

BUILT-IN POWERSTRIP
on Most Models



*Caster Assembly Required

SCIENCE CARTS | MSC SERIES
Mobile Science Carts



A Cart for Everyone!

Models



Shared Features



All Carts Include 4 Swivel Casters, 2 Locking

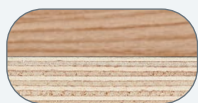

Oak Veneer Plywood Core Cabinet and Shelves



Modern Two-Tone Black Edge and Hardware on Oak Panel Look



Doors Feature Five-knuckle Wrap-Around Hinges



Doors/Drawers Lock To Keep Contents Safe



Magnetic Ganging to Connect Multiple Cabinets and Form a Worksurface



All Carts are the Same Height (Excluding MSC05), to Enable Seamless Connection with Gangers



Tabletops



Chem-Res
 1" Particleboard Core
 Chemical Resistant Top
 Edge Banding
 (no code)



Phenolic
 .75" Solid Phenolic
 Designer Beveled Edges
 (P)

OPTIONAL SINK & WHITEBOARD/MIRROR FEATURES

Only Available for MSC01, MSC02, MSC03, and MSC06 Models

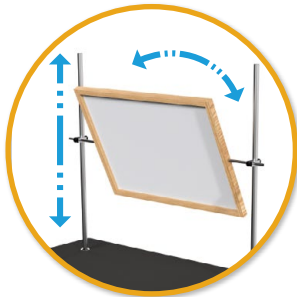

Adjust the **Height and Tilt** according to your needs

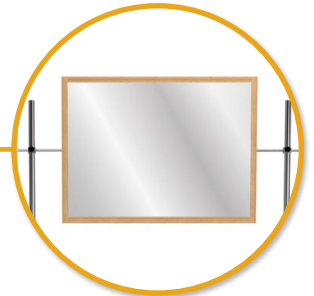
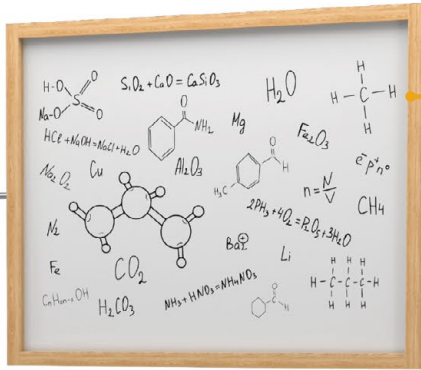

Dual purpose:
Whiteboard & Mirror framed in solid wood

(Available only for MSC01, MSC02, MSC03, and MSC06)



Stainless Steel Sink with a Hand Pump Faucet

(Available only for MSC01, MSC02, MSC03, and MSC06)



Two Jugs included with Sink Option.
Fill one with water and use the other for disposal



10-Outlet + 4 USB Input Surge Protected Power Strip, 15ft Cord, and Built-in Hook

(Available only for MSC01, MSC02, MSC03, and MSC06)

Mobile Science Cart

with Shelving

Maximize Storage and Efficiency with Our Science Cart Featuring Two Long Shelves!



Two Adjustable Height Shelves

Open Storage Area When Sink Is In Use

Dimensions

Overall 28"W x 48"L x 36.25"H

See Page 82 & 83 for Shared Features

7 DAY QUICK SHIP



Model Number & Configuration

Personalize Your Standard Cart!

Model Number Mirror/Whiteboard (if applicable)
MSC01 P WS
 Phenolic Tabletop (if applicable) Sink (if applicable)



MSC01

Standard

MSC01S

Sink

MSC01W

Whiteboard/Mirror

MSC01WS

Whiteboard/Mirror & Sink

Mobile Science Cart

with Inner Drawers and Shelf

Unleash Organization with 4 Inner Drawers + 1 Shelf



Open Storage Area When Sink Is In Use

Adjustable Height Shelf

Four Concealed Drawers

Dimensions

Overall 28"W x 48"L x 36.25"H



See Page 82 & 83 for Shared Features



7 DAY QUICK SHIP



Model Number & Configuration

Personalize Your Standard Cart!

Model Number Mirror/Whiteboard (if applicable)

MSC02 P WS

Phenolic Tabletop (if applicable) Sink (if applicable)



MSC02
Standard



MSC02S
Sink



MSC02W
Whiteboard/Mirror



MSC02WS
Whiteboard/Mirror & Sink

Mobile Science Cart

with External Drawers and Pegboard

Smart Science, Smart Storage – Unleash the Possibilities.



Three External Drawers and a Pull-out Shelf on Slides

Pullout Pegboard With 50 Assorted Pegs

Adjustable Height Shelf
Open Storage Area When Sink Is In Use

Dimensions

Overall 28"W x 48"L x 36.25"H

See Page 82 & 83 for Shared Features

7 DAY QUICK SHIP



Model Number & Configuration

Personalize Your Standard Cart!

Model Number Mirror/Whiteboard (if applicable)
MSC03 P WS
 Phenolic Tabletop (if applicable) Sink (if applicable)



MSC03



MSC03S



MSC03W
Whiteboard/Mirror



MSC03WS
Whiteboard/Mirror & Sink

*Where Organization Meets Mobility:
24 Tote Trays in Our Mobile Science Cart.*

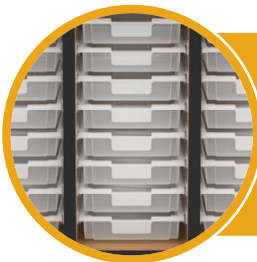

SHIPS WITH

24 TOTE TRAYS

Made of Heavy-Duty Translucent Polypropylene Material

Removeable Storage Trays Nest when Not in Use



Trays Feature Built-In Name Card Slots



Trays Feature a Built-in Handle and Smooth Edges



See Page 84 for Shared Features

Model Number
MSC04 P
Phenolic Tabletop (if applicable)



7 DAY QUICK SHIP

Dimensions

Overall	28"W x 48"L x 36.25"H
Trays	12.5"W x 17"L x 3"H

Mobile Science Cart

with Microscope Dividers

See More, Store More – Dual-Sided Microscope Storage.



Adjustable Height
Removable Shelf
on Each Side



Doors Open on Both Sides
of Cart with Five-Knuckle
Wrap-Around Hinges

Removable Microscope
Dividers to Maximize
Storage Options



See Page 84 for
Shared Features

Model Number

MSC05 P

Phenolic Tabletop
(if applicable)

Dimensions

Overall 28"W x 48"L x 41.5"H



Mobile Science Cart

with Inner Drawers and Pegboard

Optimize Space with 4 Inner Drawers + 1 Pegboard.



Four Concealed Drawers

Pullout Pegboard With 50 Assorted Pegs

Dimensions

Overall 28"W x 48"L x 36.25"H

See Page 82 & 83 for Shared Features

7 DAY QUICK SHIP

BUILT-IN MAGNETIC GANGLING

BUILT-IN POWERSTRIP

4 SWIVEL CASTERS 2 LOCKING

Model Number & Configuration

Personalize Your Standard Cart!

Model Number Mirror/Whiteboard (if applicable)

MSC06 P WS

Phenolic Tabletop (if applicable) Sink (if applicable)



MSC06
Standard



MSC06S
Sink



MSC06W
Whiteboard/Mirror



MSC06WS
Whiteboard/Mirror & Sink

Mobile Science Cart



MSC01



MSC02



MSC03



MSC04



MSC05



MSC06

Uniques Features	-Two adjustables height shelves	-Adjustable height shelf -Four concealed drawers	-Adjustable height shelf -Three external drawers -External Pullout shelf on sliders -Pullout Pegboard with 50 assorted Pegs	-24 Removable storage Tote Trays made of heavy-duty translucent polypropylene material.	-Dual side storage -Adjustable height shelf on each side -20 Removable microscope dividers	-Four concealed drawers -Pullout Pegboard with 50 assorted Pegs
Dimensions	Overall 28"W x 48"L x 36.25"H	Overall 28"W x 48"L x 36.25"H	Overall 28"W x 48"L x 36.25"H	Overall 28"W x 48"L x 36.25"H Trays 12.5"W x 17"L x 3"H	Overall 28"W x 48"L x 41.5"H	Overall 28"W x 48"L x 36.25"H
Doors	Two doors with Five-knuckle wrap-around hinges	Two doors with Five-knuckle wrap-around hinges	Two doors with Five-knuckle wrap-around hinges	Two doors with Five-knuckle wrap-around hinges	Two doors with Five-knuckle wrap-around hinges	Two doors with Five-knuckle wrap-around hinges
Lock System	Door	Door	Door and drawers	Door	Door (both sides)	Door
Weight	160 Lbs	155 Lbs	170 Lbs	165 Lbs	150 Lbs	155 Lbs
Tabletop	Chem-res Particleboard Core Black Pvc Edge Banding 1" Thick or Solid Phenolic Designer Beveled Edges .75" Thick	Chem-res Particleboard Core Black Pvc Edge Banding 1" Thick or Solid Phenolic Designer Beveled Edges .75" Thick	Chem-res Particleboard Core Black Pvc Edge Banding 1" Thick or Solid Phenolic Designer Beveled Edges .75" Thick	Chem-res Particleboard Core Black Pvc Edge Banding 1" Thick or Solid Phenolic Designer Beveled Edges .75" Thick	Chem-res Particleboard Core Black Pvc Edge Banding 1" Thick or Solid Phenolic Designer Beveled Edges .75" Thick	Chem-res Particleboard Core Black Pvc Edge Banding 1" Thick or Solid Phenolic Designer Beveled Edges .75" Thick
Color	Oak Veneer	Oak Veneer	Oak Veneer	Oak Veneer	Oak Veneer	Oak Veneer
Powerstrip	10-Outlet + 4 USB Input Surge Protected Power Strip, 15ft Cord, and Built-in Hook	10-Outlet + 4 USB Input Surge Protected Power Strip, 15ft Cord, and Built-in Hook	10-Outlet + 4 USB Input Surge Protected Power Strip, 15ft Cord, and Built-in Hook	-	-	10-Outlet + 4 USB Input Surge Protected Power Strip, 15ft Cord, and Built-in Hook
Ganging	Built-in Magnetic Ganging	Built-in Magnetic Ganging	Built-in Magnetic Ganging	Built-in Magnetic Ganging	Built-in Magnetic Ganging <i>(will only gang to other microscope carts)</i>	Built-in Magnetic Ganging
Casters	4 Swivel Casters, 2 Locking	4 Swivel Casters, 2 Locking	4 Swivel Casters, 2 Locking	4 Swivel Casters, 2 Locking	4 Swivel Casters, 2 Locking	4 Swivel Casters, 2 Locking
Sink	Optional Stainless Steel Sink with a Hand Pump Faucet, Two jugs included	Optional Stainless Steel Sink with a Hand Pump Faucet, Two jugs included	Optional Stainless Steel Sink with a Hand Pump Faucet, Two jugs included	-	-	Optional Stainless Steel Sink with a Hand Pump Faucet, Two jugs included
Whiteboard/Mirror	Optional Dual purpose: Whiteboard & Mirror framed in solid wood	Optional Dual purpose: Whiteboard & Mirror framed in solid wood	Optional Dual purpose: Whiteboard & Mirror framed in solid wood	-	-	Optional Dual purpose: Whiteboard & Mirror framed in solid wood
Lead Time	7 Days	7 Days	7 Days	7 Days	7 Days	7 Days

Looking for a Storage Cart?

See our Model MSC2436



The **NPS® Mobile Science Storage Cabinet** is an important addition to your science lab. It functions as a **WORKSTATION, MOBILE STORAGE CABINET** and as a **DEMONSTRATION TABLE**.



Features *This Model Ships Unassembled*



1 1/4" Thick High Pressure Laminated Surface, Compliant With NEMA Standard Testing

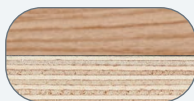

Fully Oak Veneer Plywood Core Cabinet and Shelf



Modern Two-Tone Black Edge and Hardware on Oak Panel Look



2 Doors With 270° Wrap-Around Hinges



Keep Contents Safe with Built-in Door Lock



One Adjustable Height Removable Shelf



Shelf Can Be Adjusted in 1" Increments to 5 Heights



4 Heavy Duty 4" Swivel Locking Casters



Specs

Overall	24"W x 36"L x 36"H
Product Weight	103 lbs

HEXAGON WORKSTATION



*Empower Your Team's
Potential with the NPS
Hexagon Workstation*

Empower your students, enhance their learning experience, and create a more engaging classroom environment with the NPS Hexagon Workstation.

This dynamic workstation comfortably accommodates 6 students around it. What sets Hexagon Workstation apart is its thoughtful design maximizing the workstation capacity while also ensuring that every student has easy access to electricity with strategically placed outlet plugs.



6 WORKSTATIONS
With full access to all features



MODERN DESIGN
Modern Two-Tone Black Edge
and Hardware on Oak Panel Look



BUILT-IN EXTRA STORAGE
For personal/working elements

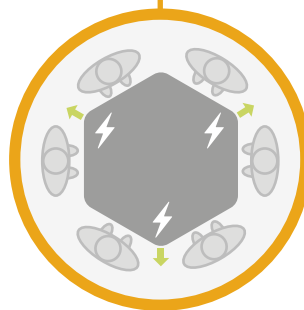

3 EXTERNAL POWERS HUBS
For uninterrupted connectivity

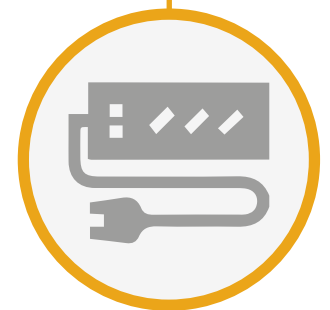

INTERNAL POWER HUB
For easy setup

Hexagon Workstation

Drawers

CODE: D

-OR-

Book Boxes

CODE: B



6 Plywood Core Drawers with an Ergonomically Carved Handle Design. Drawers Lock To Keep Contents Safe



6 Book Boxes for Open Storage with Easy Accessibility. Inner Dimensions 15.75" W x 11" D x 4.5"H



Doors Lock To Keep Contents Safe

One Adjustable Height Shelf

Optionally Installed Rubber Toe Kick to Protect Against Spills or Damages

Doors Feature Five-knuckle Wrap-Around Hinges

Add-Ons



2 Gas+Cold Water Fixtures

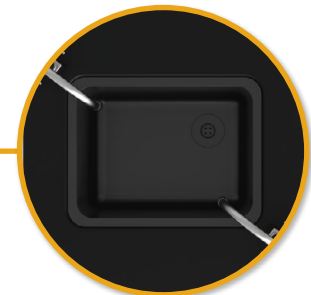

Solid Epoxy Resin Sink
with Drain, Sink Outlet and Stopper
(Available only with Phenolic Tabletop)



Internal Power Hub
10-Outlet + 4 USB Input Surge
Protected Power Strip with a 15ft Cord



3 UL Approved Powers Hubs

Each Power Hub is Rated at 125v, 60Hz, 15A, and Offers the Following Features:

- Two Tamper-Resistant AC Outlets
- One USB Type-A charging port delivering 5V at 2.1A (10.5W)
- One USB Type-C charging port providing 5V at 2.4A (12W)
- Built-in 10-foot power cord (14 AWG x 3C) that is routed to the power strip inside the cabinet.

Tabletops



Chem-Res
1" Particleboard Core
Chemical Resistant Top
Edge Banding
(C)



Phenolic
.75" Solid Phenolic
Designer Beveled Edges
(P)



Epoxy
1" Solid Epoxy
Designer Beveled Edges
(E)

Add-Ons Description

S	Standard
P	Built-In Power Hubs
ESFG	Epoxy Sink & Gas-Water Fixtures

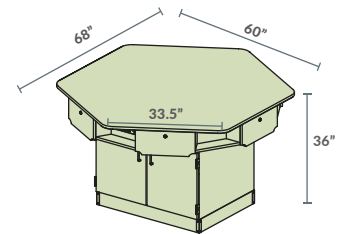

Options Available



Base Design



Cabinet
(C)

Apron Style Options

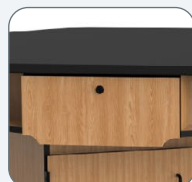

Drawers
(D)



Book Boxes
(B)

Model Number Configuration

Prefix | Tabletop | Power Add-on
WSH P-C D P ESFG
Apron Style | Epoxy Sink & Gas-Water Fixtures Add-on

SCIENCE TABLES | SLT SERIES Solid Wood Tables



Top Options

SEE PAGE 202 FOR TABLETOPS GUIDE



HPL



CHEM-RES



See page 207 for custom color options

PHENOLIC



WHITE BOARD



EPOXY*



TRESPA



SCIENCE TABLES | SLT SERIES
Solid Wood Tables



Features



Rubber Boots
Protect Against Spills



Legs Attach W/ Metal
on Metal Double Bolt
Assembly on 13-Gauge
Steel Corner Braces



Solid Ash Frame
And Legs



Adjustable Glides
for Accurate Floor
Leveling



Available
With Book
Compartments



Optional Heavy Duty
3" Thermoplastic Rubber
Casters with a side lock and
Stretchers and Braces

Model Number Configuration



Model# Description

SLT1	30" High*, Science Lab Table, Wood Frame
SLT2	36" High*, Science Lab Table, Wood Frame

Size (width/Length in inches)

2430	2448	2454	2460	2472
3030	3060	3072	4260	4272

- Lightning ship tables available, choose from tops H, C and P
 - Lightning ship tables available, choose from tops H, C, P, and W
 - Lightning ship tables available with top C only
- Standard lead time is 8 weeks.
 Lightning ship lead time is 2 days.

Top Description

W	Whiteboard
H	High-Pressure Laminate
C	Chem-Res
P	Phenolic
E	Epoxy
T	Trespa

Using Epoxy tables in mobile applications with casters voids the warranty.

Add-on Description

B	Add Book Boxes
C	Add Casters* & Stretchers

*Additional 3.5" Height when ordered with Casters

All tables wider than 30", longer than 72", or with Epoxy/Trespa tabletops will include stretchers and braces



SCIENCE TABLES | SLT SERIES

Steel Tables

Top Options

SEE PAGE 202 FOR TABLETOPS GUIDE



HPL



CHEM-RES



See page 207 for custom color options

PHENOLIC



EPOXY*



TRESPA



Features



Corner Brackets Bolted Onto Frame



Welded 12-Gauge Leg Top Plate



11-Gauge Welded Support Brackets



Leveling Glides Can Add up to 3/4" Height to Table

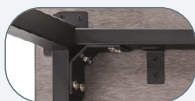

Dual-Side Leg Connection



Adjustable Legs Adjust in 1" Increments



16-Gauge Channel Frame



Optional Heavy-Duty 3" Thermoplastic Rubber Casters with a side lock and Gussets Available



PATENTED PERSONAL TABLE ***

Color Options



Black



Soft Grey

Model Number Configuration

Model Number Size Top Material

SLT3 - 2448 H

Size (width/Length in inches)

2430 2448 2454 2460 2472

3030 3060 3072 4260 4272

● Lightning ship tables available, choose from tops H, C and P

● Lightning ship tables available with top C only

Standard lead time is 8 weeks.

Quick ship lead time is 7 days.

Top Description

H	High-Pressure Laminate
C	Chem-Res
P	Phenolic
E	Epoxy
T	Trespa

Using Epoxy tables in mobile applications with casters voids the warranty.

Model# Description

SLT3	Height adjustable steel table, black
SLT7	Fixed Height steel table, black
SLT8	Height adjustable steel table, soft grey
SLT9	Fixed Height steel table, soft grey

Caster/Gusset Model

Model Number Frame Number (of table that it will be used with)

CAST-3



Without Casters



With Casters



products meet or exceed applicable ANSI/BIFMA standards

Additional 3.5" Height when ordered with Casters

All tables wider than 30", longer than 72", or with Epoxy/Trespa tabletops will include a set of gussets



Top Options

SEE PAGE 202 FOR TABLETOPS GUIDE



HPL



CHEM-RES



See page 207 for custom color options

PHENOLIC



Features



Available With Book Compartments



Aprons Made of Solid Ash



Aprons Reinforced With 13" Gauge Steel Corner Brackets



Legs Adjust in 3/4" Increments from 27"-42"H With Included Spacer



11-Gauge Leg-Bases Fastened to Tabletop With 6 Heavy-Duty Screws



Legs Come Standard With Simple-Adjust Glides for Accurate Floor Leveling



Optional Casters Available for Lightweight Use

Model Number Configuration

Model Number Size Top Material Add-Ons
SLT4 - 2448 H BC

Model# Description

- SLT4 Black Legs, Signature table w/ black legs
- SLT5 Oak Legs, Signature table w/ oak legs

Size (width/Length in inches)

- 2430 2448 2454 2460 2472
- 3030 3060

Lightning ship tables available, choose from tops H, C, and P
 Standard lead time is 8 weeks.
 Quick ship lead time is 7 days.

Leg Options



Black

Oak

Top	Description
H	High-Pressure Laminate
C	Chem-Res
P	Phenolic

Add-on	Description
B	Add Book Boxes
C	Add Casters



Designer Tables

Top Options

SEE PAGE 202 FOR TABLETOPS GUIDE



HPL



CHEM-RES



PHENOLIC



BUTCHERBLOCK



WHITEBOARD



Features



1.2" Thick Reinforcement Board Under Tabletops for Added Strength



Legs Adjust in 3/4" Increments from 27"-42"H With Included Spacer



11-Gauge Leg-Bases Fastened to Tabletop With 6 Heavy-Duty Screws



Legs Come Standard With Simple-Adjust Glides for Accurate Floor Leveling



Optional Casters Available for Lightweight Use

Model Number Configuration

Model Number Size Top Material Add-Ons

SLT6 - 2448 H C

Size (width/Length in inches)

2430 2448 2454 2460 2472

3030 3060

● Lighting ship tables available, choose from tops H, C, and P

Standard lead time is 8 weeks.
Quick ship lead time is 7 days.

Top Description

W	Whiteboard
B	Butcherblock
H	High-Pressure Laminate
C	Chem-Res
P	Phenolic

Add-on Description

C	Add Casters
---	-------------



products meet or exceed applicable ANSI/BIFMA standards

SCIENCE TABLES | SLT SERIES
Steel Designer Tables



Innovative Designer Apron



For more specs see page 71

Model#	Description
SLTD3	Height adjustable steel table, black
SLTD7	Fixed Height steel table, black
SLTD8	Height adjustable steel table, soft grey
SLTD9	Fixed Height steel table, soft grey

Top Options
SEE PAGE 202 FOR TABLETOPS GUIDE



CHEM-RES (C)



PHENOLIC (P)



EPOXY (E)



TRESPA (T)

Size (width/Length in inches)

1824	1830	1836	1842	1848	1854	1860	1872
2424	2430	2436	2442	2448	2454	2460	2472
3030	3036	3042	3048	3054	3060	3072	

- Quick ship tables available, choose from tops C, P, and H with grey nebula laminate
 - Quick ship tables available, choose from tops P and C
- Standard lead time is 8 weeks. Quick ship lead time is 7 days.

Color Options

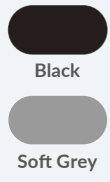

Model Number Configuration

Model Number | Size | Top Material

SLTD3 - 2448 C



Steel Activity Tables



For more specs see page 75

Model Number Configuration

Model Number | Size | Top Material

SLTA7 - TZ 2448 C

Shape

Top Options
SEE PAGE 202 FOR TABLETOPS GUIDE



CHEM-RES (C)

Shapes

Trapezoid (TZ)	Tri (TR)	Square (SQ)
Semicircle (SC)	Hexa (HX)	Round (RD)

Trapezoid Sizes (TZ) (Width/Length in Inches)	Tri Sizes (TR) (Width/Length in Inches)
2448 2454 2460 2472 3054 3060 3072	2454 2460 3054 3060
Square Sizes (SQ) (Width in Inches)	Semicircle Sizes (SC) (Diameter of Full Circle in Inches)
24 30 36 42 48	48 60
Hexa Sizes (HX) (Width/Length in Inches)	Round Sizes (RD) (Diameter in Inches)
2454 2460	36 42 48 60





WORKSTATIONS

**Sit Stand
Desks**
EDTC, SSD



Workstations
Teacher's EduPod
Teacher's WorkPod



WORKSTATIONS | EDTC SERIES
Sit Stand Students Desk



Features



Strong Powder-Coated Steel Frame



2 1/2" Two-Tone Double-Wheel Hooded Casters



Pneumatic Adjusting System

Model Number
EDTC

Color

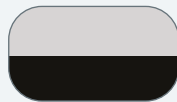

Speckled Grey Surface
 Black Steel Frame

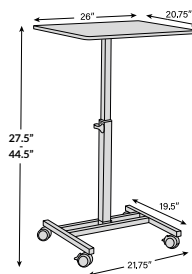

Description

Dimensions

Top Shelf Dimensions	26" L x 20.75" D
Height Adjustable	27.75" - 44.5" 30"
Leg Dimensions	21.75" L x 19.5" D
Unit Weight	35 lbs.



Features



Strong Powder-Coated Steel Frame



2 1/2" Two-Tone Double-Wheel Hooded Casters



One Button Click Pneumatic Adjusting System



Book-Bag Holder



Plastic Surface With Embedded Tablet Groove



Built-in Modesty Panel

Colors



Charcoal Grey Surface
 Soft Grey Frame



Model Number
SSDG-20



products meet or exceed applicable ANSIBIFMA standards



Description

Surface Dimensions
 Height Adjustable
 Distance Between Legs

Dimensions

23.5" W x 19.5" D
 28.5" - 41.75"
 21.5"

WORKSTATIONS | EDPD SERIES
Edupod Teacher's Desk & Lectern



Features



Beautiful Blow-Molded Table Top



3 Shelves, 2 Adjustable for Customizability

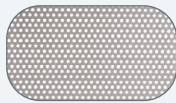

Built-in Perforated Modesty Panel



Locking Storage Cabinet for Security



Wire Management Grommet for Technology Equipment



6 Hooded Twin-Wheel, Two-Inch Casters, 3 Lock for Stability

Colors

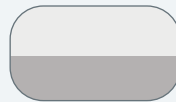

Speckled Grey Tabletop
 Grey Hammer Tone Cabinet and Frame

Model Number
EDPD

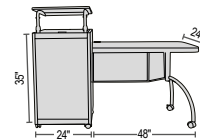

Description

Dimensions

68" L x 24" W	Overall Dimensions
48" L x 24" W	Desk Dimensions
2-inch	Desk Thickness
24" L x 20" W x 35" H	Cabinet Dimensions (including casters)
24" L x 20" W	Lectern Desk
3/4-inch	Lectern Thickness
19" L x 22" W	Cabinet Shelves Dimensions
115 lbs.	Unit Weight
85 lbs.	Lectern Portion Weight



Colors



Charcoal Slate and Black

Features



Double Frame for Added Support

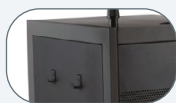

Desk Can Be Hooked on to Either Side of the Lectern

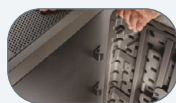

Unhook the Desk from the Lectern to Use Separately



Built-in Attractive Mesh Front Provides Venting to Prevent Overheating



Contemporary Frame and Legs



Adjustable Height Surface with Metal Bookstop

Model# Description

TWPD	Teacher's WorkPod Desk
TWPL	Teacher's WorkPod Lectern
TWP	Teacher's WorkPod Desk & Lectern Kit

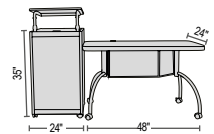

Description Dimensions

68" L x 24" W	Overall Dimensions
48" L x 24" W	Desk Dimensions
2-inch	Desk Thickness
24" L x 20" W x 35" H	Cabinet Dimensions (including casters)
24" L x 20" W	Lectern Desk
3/4-inch	Lectern Thickness
19" L x 22" W	Cabinet Shelves Dimensions
115 lbs.	Unit Weight
85 lbs.	Lectern Portion Weight







MOBILE TABLES

Mobile Table

MT, MTFB,
MTS, MTSB



Easy Fold

MTSSF



Convertible Bench

CBG



Booth Seating

TG, CSB



Our tables come in

Rectangle



Square



Hexagon



Octagon



all shapes and sizes

Round



Oval



Elliptical



>>>>>>
SEE NEXT PAGE FOR
**DESIGNER
SHAPES**
>>>>>>

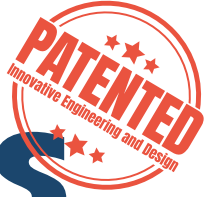

Designer Shapes

Swerve Table

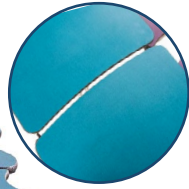

Bedrock Table

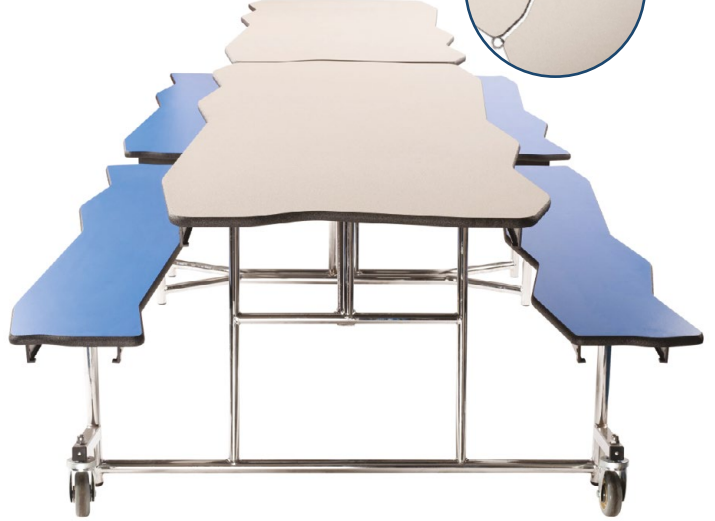

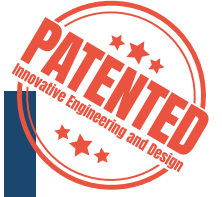

ErgoMax Stool

14" Wide



*An Ergonomically
Designed Mobile
Table Stool for
Maximum Comfort.*



Table & Bench Core Options



3/4" MDF (MD)



3/4" Particleboard (PB)



3/4" Plywood (PW)

Frame Color Options



Chrome (CR)



Black Powder Coating (PC)

Table/Seat Heights*

25"/13"
code: 25

27"/15"
code: 27

29"/17"
standard‡

32"/20"
code: 32

*For non-standard heights add code to end of model number
‡Standard MTS1216 is 27"/15"



Mobile Table Features Stool, Bench, Shape, and Combo Units



Casters Lift off Floor to Prevent Table from Moving When Opened



Tamper-Free, Non-Marring, Nylon Steel-Insert Glides and Tube Closures



Protect Edge Option Prevents Food from Being Trapped Between the Laminate and Edge



Self-Leveling Automatic Down Lock Ensures Engagement Every Time Table Is Fully Opened



Locks Table Partially Open for Easy Floor Cleaning



No Need to Reach in! Storage Latch Release Handles on Both Sides of Table to Unlock. Locks Automatically When Folded



4" Double Ball Bearing Non-Marring Heavy-Duty Casters With 275 Lb. Weight Capacity Ea



"EasyLift" Torsion Bar System. One Person Can Easily Lift and Fold Table for Convenient Storage



14-Gauge Steel Framing

Bench Features



Prevent Tripping During Entry With Our Exclusive Curved Frame Design



3/4" Thick Benches Reinforced With 16-Gauge Aprons

Stool Features



High Impact Stools Reinforced With Embedded Steel Washers



Hex-Head Serrated Flange Bolts & Serrated Flange Nylon Insert Nuts Provides Stronger and Simpler Assembly

Easy Fold Features



One-Piece Top Eliminates the Gap in the Middle of Surface



4" Double Ball Bearing Non-Marring Heavy-Duty Casters With 275 Lb. Weight Capacity Ea



Casters Lift off Floor to Prevent Table from Moving When Opened



Gas Spring Rated to 100,000 Cycles Balances Open-Fold Operation - Simple for One Person Operation



Automatically Locks Open With Two Points of Manual Release to Fold

Convertible Bench Features



Create One Large Table By Combining Single Bench Units, Using the Built-in Ganging Devices



Non-Marring Reinforced Nylon Glides With Steel Inserts Installed Over Leg Uprights.



"Pinch-Proof" Feature: Bench Does Not Touch the Top When Folding



Under Table Hat Supports 1000 Lbs. Weight Capacity (CBG96 Only)



Easy Lock 3" Double Ball-Bearing Heavy-Duty Casters





>>>>>>

ADD YOUR

LOGO!

JUST SEND IN AN .AI FILE

>>>>>>



Shape Tables

*Mobile tables that
shape up to your unique
seating needs.*





See Page 116 for Product Features



Shapes

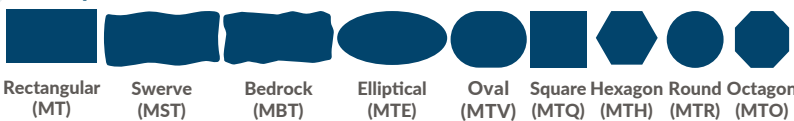

Rectangular (MT) Swerve (MST) Bedrock (MBT) Elliptical (MTE) Oval (MTV) Square (MTQ) Hexagon (MTH) Round (MTR) Octagon (MTO)



7 DAY QUICK SHIP

MT12-MDPEPCGY
(12' Rectangle, MDF/ProtectEdge, Textured Black Frame, Grey Nebula Top)
MT60R-MDPEPCGY
(60" Round, MDF/ProtectEdge, Textured Black Frame, Grey Nebula Top)

Model Number Configuration

Model # Core Edge Frame Laminate Color Top

MTE10-MD PE CR CH

Add custom height to the end of model number

ADA Configurations

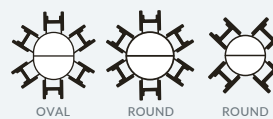

OVAL ROUND ROUND

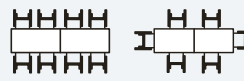

12' TABLE 10' TABLE

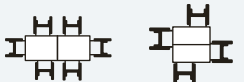

8' TABLE SQUARE conditional based on wheelchair width



Model #	Shape	Table WxL	Folded Dimensions	Table Height (Standard)	Table Height (Custom)
MT8	Rectangular	30"x97"	30"x30"x60"	29"	
MT10	Rectangular	30"x121"	31"x30"x68"	29"	
MT12	Rectangular	30"x145"	32"x30"x81½"	29"	
MST8	Swerve	30"x97"	30"x30"x60"	29"	25"
MST10	Swerve	30"x121"	31"x30"x68"	29"	27"
MST12	Swerve	30"x145"	32"x30"x81½"	29"	32"
MBT8	Bedrock	30"x97"	30"x30"x60"	29"	
MBT10	Bedrock	30"x121"	31"x30"x68"	29"	
MBT12	Bedrock	30"x145"	32"x30"x81½"	29"	
MTE10	Elliptical	44½"x121½"	31¼"x 44⅝"x 67¼"	29"	
MT72V	Oval	60"x72"	19"x60"x45¼"	29"	
MT48Q	Square	48"x48"	19"x48"x39¼"	29"	25"
MT60Q	Square	60"x60"	19"x60"x42¼"	29"	27"
MT48H	Hexagon	48"x48"	19"x48"x39¼"	29"	32"
MT48R	Round	48"x48"	19"x48"x39¼"	29"	42"
MT60R	Round	60"x60"	19"x60"x42¼"	29"	
MT72R	Round	72"x72"	19"x72"x45¼"	29"	
MT60O	Octagon	60"x60"	19"x62½"x42¼"	29"	

Bench Tables

Better together! Bench tables make group seating simple.





See Page 116 for Product Features



7 DAY QUICK SHIP

MTFB12-MDPEPCGGY
 (12' Rectangle, MDF/ProtectEdge, Textured Black Frame, Grey Nebula Top & Bench)
MTR60B-MDPEPCGGY
 (60" Round, MDF/ProtectEdge, Textured Black Frame, Grey Nebula Top & Bench)

Shapes



Model Number Configuration

Model # Core Edge Frame Tabletop Laminate
MTFB12-MD PE CR CH GY
 Add custom height and/or ADA code to the end of model number Bench Laminate

Model #	Shape	Seats	Table WxL	Folded Dimensions	Table Height (Standard)	Table Height (Custom)
MTFB8	Rectangular	8-12	30"x97"	56"x34½"x59¾"	29"-17"	
MTFB10	Rectangular	10-14	30"x121"	56"x35"x68½"	29"-17"	
MTFB12	Rectangular	12-16	30"x145"	56"x35½"x81"	29"-17"	
MSTB8	Swerve	8-12	30"x97"	56"x34½"x59¾"	29"-17"	
MSTB10	Swerve	10-14	30"x121"	56"x35"x68½"	29"-17"	25"-13"
MSTB12	Swerve	12-16	30"x145"	56"x35½"x81"	29"-17"	27"-15"
MBTB8	Bedrock	8-10	30"x97"	56"x34½"x59¾"	29"-17"	32"-20"
MBTB10	Bedrock	10-12	30"x121"	56"x35"x68½"	29"-17"	
MBTB12	Bedrock	12-16	30"x145"	56"x35½"x81"	29"-17"	
MTEB	Elliptical	10-12	45"x121"	72"x35½"x73½"	29"-17"	
MTR60B	Round	8	60"x60"	34"x86"x54½"	29"-17"	
MTO60B	Octagon	8	60"x60"	34"x86"x54½"	29"-17"	

ADA Configurations

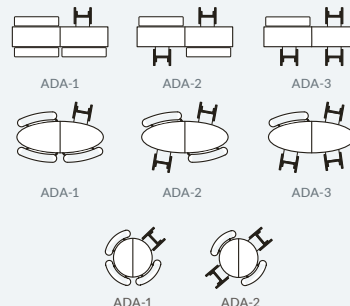

conditional based on wheelchair width





Stool Tables

*Roll in, roll out, flip,
and store. Pairs well
with any seating!*





See Page 116 for Product Features



Shapes



MTS1216-MDPEPCGYxx (12' Rectangle, MDF/ProtectEdge, Textured Black Frame, Grey Nebula Top)
 MTS12-MDPEPCGYxx (12' Rectangle, MDF/ProtectEdge, Textured Black Frame, Grey Nebula Top)
 MTR60S-MDPEPCGYxx (60" Round, MDF/ProtectEdge, Textured Black Frame, Grey Nebula Top)

Model #	Shape	Seats	Table WxL	Folded Dimensions	Table Height (Standard)	Table Height (Custom)
MTS8	Rectangular	8	30"x97"	30"x59"x57"	29"-17"	25"-13"
MTS10	Rectangular	12	30"x121"	59"x36"x73½"	"	27"-15"
MTS12	Rectangular	12	30"x145"	59"x39"x79¾"	29"-17"	
MTS1216	Rectangular	16	30"x145"	59"x35"x81¾"	"	25"-13"
MTS1316*	Rectangular	16	30" x 156¾"	41" x 59.12" x 91"	29"-17"	
MSTS8	Swerve	8	30"x97"	56"x34½"x59¾"	"	25"-13"
MSTS10	Swerve	12	30"x121"	56"x35"x68½"	27"-15"	27"-15"
MSTS12	Swerve	12	30"x145"	56"x35½"x81"	"	32"-20"
MSTS1216	Swerve	16	30"x145"	59"x35"x81¾"	29"-17"	25"-13"
MBTS8	Bedrock	8	30"x97"	32"x59"x57"	29"-17"	25"-13"
MBTS10	Bedrock	12	30"x121"	59"x36"x73½"	"	27"-15"
MBTS12	Bedrock	12	30"x145"	59"x39"x79¾"	29"-17"	32"-20"
MBTS1216	Bedrock	16	30"x145"	59"x35"x81¾"	"	25"-13"
MTR60S	Round	8	60"x60"	38"x81"x54½"	29"-17"	25"-13" 27"-15"
MTO60S	Octagon	8	60"x60"	38"x81"x54½"	29"-17"	32"-20"
MTES	Elliptical	12	45"x121"	59"x35"x81¾"	29"-17"	25"-13" 27"-15"

*Custom SKU: Extra-tall 91" folded height, high doorway and special shipping requirements. Non-refundable/cancellable after order.

Model Number Configuration

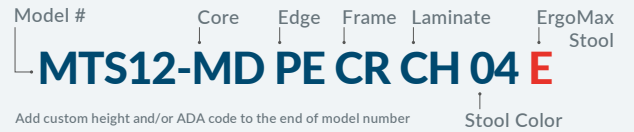

ADA Configurations

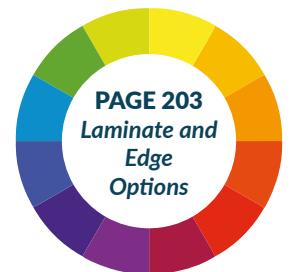
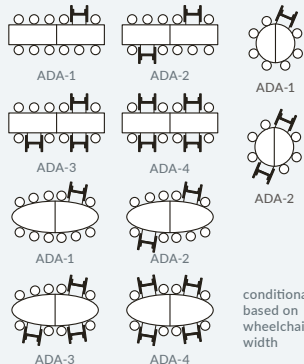



Combo Tables

The best of both worlds - bench or stool, sit together how you'd like!





See Page 116 for Product Features



Shapes

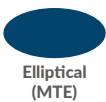

Elliptical (MTE)



Round (MTR)



Octagon (MTO)

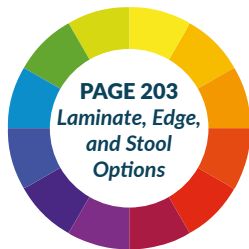

Model Number Configuration

Model # Core Edge Bench Laminate Stool Color
MTR60SB-MD PE CR XX XX XX E
 Add custom height and/or ADA code to the end of model number
 Frame Tabletop Laminate ErgoMax Stool

Model #	Shape	Seats	Table WxL	Folded Dimensions	Table Height (Standard)	Table Height (Custom)
MTE5B	Elliptical	12	45"x121"	59"x35"x81½"	29"-17"	25"-13"
MTR60SB	Round	8	60"x60"	38"x81"x54½"	29"-17"	27"-15"
MTO60SB	Octagon	8	60"x60"	38"x81"x54½"	29"-17"	32"-20"

ADA Configurations



ADA-1



ADA-2

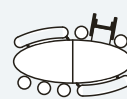

ADA-1

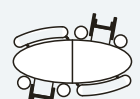

ADA-2

conditional based on wheelchair width

Easyfold Units

*Roll in, roll out, flip,
and store. Pairs well
with any seating!*





See Page 116 for Product Features



Shapes

- 
Oval
(V)
- 
Square
(Q)
- 
Round
(R)
- 
Octagon
(O)
- 
Hexagon
(H)

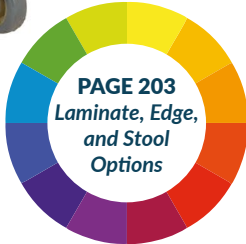

Model #	Shape	Table WxL	Folded Dimensions	Table Height (Standard)	Table Height (Custom)
MTSSF-60V	Oval	60"x72"	72"x20"x72"	29"	
MTSSF--48Q	Square	48"x48"	48"x20"x62"	29"	
MTSSF-60Q	Square	60"x60"	60"x20"x72"	29"	25"
MTSSF-48R	Round	48"x48"	48"x20"x62"	29"	27"
MTSSF-60R	Round	60"x60"	60"x20"x72"	29"	32"
MTSSF-60O	Octagon	60"x60"	60"x20"x72"	29"	42"
MTSSF-48H	Hexagon	48"x48"	48"x20"x65"	29"	

7 DAY QUICK SHIP MTSSF-60R-MDPEPCGY (Round 60"x60", MDF Core, Black Protect Edge, Grey Nebula Top)

Model Number Configuration

Model # Core Edge Frame Laminate Color Top

MTSSF-48Q-MD PE CR CH

Add custom height to the end of model number

Convertible Bench Units

*Adaptable for your
cafeteria, auditorium
and testing center!*





Open



See Page 116 for Product Features

Flip



Gang



PAGE 203
Laminate, Edge,
and Stool
Options

TAA ✓

7 DAY QUICK SHIP

CBG96-MDPEPCGYG
(96" L, MDF Core, Black Protect Edge, Grey Nebula Back and Bench)

UL CERTIFIED

Model #	Seats	Table WxL	Folded Dimensions	Table Height (Standard)	Table Height (Custom)
CBG72	3-4	29"x72"	72"x12"x34"	29"-17"	25"-13"
CBG84	4-5	29"x84"	84"x12"x34"	29"-17"	27"-15"
CBG96	4-6	29"x96"	5696"x12"x34"	29"-17"	32"-20"

Model Number Configuration

Model # Core Edge Frame Back Laminate

CBG96-MD PE PC CH GY

Bench Laminate



Booth Seating





*Transforming cafeterias into cafes.
Roll and swivel into booth seating.*

ToGo Specs



BOOTH SEATING

The ToGo Benches Feature Fixed High Backs With a Slight 12-Degree Pitch Providing the Perfect Contour for Comfortable Seating.



MOBILE

Built With 14-Gauge Steel, 2" Tube Legs, and Double Ball-Bearing Non-Marring 3" Casters, the ToGo Provides the Ultimate in Strength and Mobility.



COLLABORATIVE

Today's Cafeterias Have Become Multi-Purpose Spaces Which Require Furniture That Is Mobile and Multi-Functional. NPS's ToGo Booth System Is Ideal for Such An Environment.



SIMPLE STORAGE

The ToGo Bench and Table Top Flip up and Nest for Optimal Storage. Both Are Offered in 48" or 60" Widths and 24" or 30" Depths Providing Comfortable Seating for All Sizes.



LATCH



HEAVY-DUTY 3" CASTERS



GRIP-RITE GLIDE

EASE OF USE

It's Simple to Reconfigure for Multi-Purpose Use. With Its Heavy-Duty 3" Casters the ToGo Booth Is Easy to Move. Rubber Grip-Tight Glides Automatically Engage With the Floor When Opened Along With Locking Casters to Keep Your Seating Arrangement Nicely in Place. Tables Open and Lock Automatically and Are Easily Released With the Pull of a Handle.

19" High Back 15" Wide Seat

Compared to standard 15"x12" Convertible Bench



WITH GLOBAL MATERIALS

Table Core/Edge Options

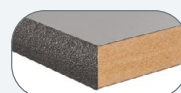

1" MDF core
HPL Surface | Protect Edge (MDPE)



1" Particleboard core
HPL Surface | T-molding (PBTM)

Model #	Seats	Open Footprint	Folded Footprint	Weight
TGT2448	2-3	24"W x 48"L x 29"H	21.25"W x 48"L x 39.50"H	58 lbs.
TGT2460	3-4	24"W x 60"L x 29"H	21.25"W x 60"L x 39.50"H	64 lbs.
TGT3048	2-3	30"W x 48"L x 29"H	21.25"W x 48"L x 39.50"H	68 lbs.
TGT3060	3-4	30"W x 60"L x 29"H	21.25"W x 60"L x 39.50"H	76 lbs.

ToGo Table



PAGE 203
Laminate, Edge,
and Stool
Options

Model Number Configuration

Model # Core Edge Laminate
TGT2448-MD PE RE



7 DAY
QUICK SHIP

TGT2460MDPEGY
(24"x60", MDF Core,
Black Protect Edge, Grey Nebula)

ToGo Bench



Bench Core/Edge Options

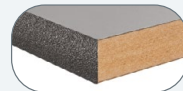

.75" MDF core
HPL Surface | Protect Edge
(MDPE)



.75" Particleboard core
HPL Surface | T-molding
(PBTM)

Model Number Configuration

Model # | Core | Edge | Back Laminate
TGB60-MD PE RE BL
 | Bench Laminate

Model #	Seats	Open Footprint	Folded Footprint	Weight
TGB48	2-3	25"W x 48"L x 38"H	17.25"W x 48"L x 38"H	74 lbs.
TGB60	3-4	25"W x 60"L x 38"H	17.25"W x 60"L x 38"H	86 lbs.



TGB60MDPENLNL
 (60", MDF Core, Black Protect Edge,
 Navy Legacy Back/Bench)



Cluster Swivel Booth



Features



Flex Back Tested by SGS Labs to Resist 425 Lbs of Force



Unique Design for Ultimate Seating Comfort

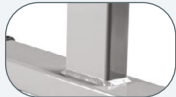

13-Gauge Heavy-Duty Steel Frame



18-1/2" Space from Tabletop to Seat Back



Seats Are Mounted on An Industrial Grade Swivel Base



T-Shaped Legs for Extreme Stability



Undertable 11-Gauge Framing System



Tamper Free Hardware

Colors

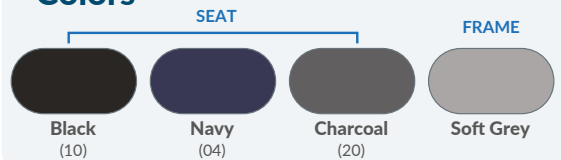

Model Number Configuration

Prefix | Edge | Laminate (HPL tops) | Seat Color

CSBG2448 PBTM xx 10

Cluster Swivel Booth

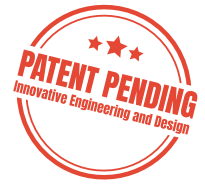

Featuring

LÜvra

FLEX

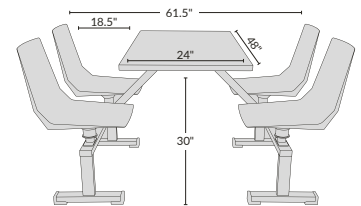
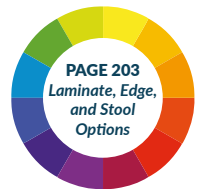

Tabletops

Tabletop Dimensions are 24" x 48"



1.2" particleboard core
HPL Surface
T-molding
(PBTM)



1.2" Particleboard
HPL Surface
PVC Edge Banding
(PB EB)

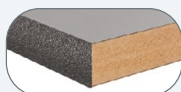

1.2" MDF core
HPL Surface
Protect Edge
(MDPE)



1.2" Particleboard Core
Whiteboard HPL Surface
PVC Edge Banding
(WB)



1.75" Solid Maple Wood
Butcherblock
Proprietary UV Finish
(BB)

See page 203 for warranty, finish options and care instructions.



products meet or exceed applicable ANSI/BIFMA standards

ADVANTAGES & BENEFITS for NPS Mobile Tables pages 112-129

Frame Design | Table Top | Seat

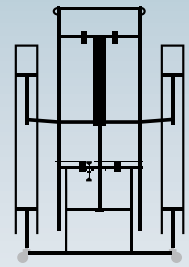

Sophistication made Simple with Safety in mind.

NPS Mobile Tables are sophisticated in design yet simple to operate. Offering enhanced safety features giving you complete peace of mind.

Frame Design *Intelligent steel understructure design supports table tops and seating providing ease of operation and maintenance.*

Table Top Apron Support

- Each top is supported by 2" deep, 14-gauge steel aprons capped at the ends with riveted plastic protectors.
- Aprons and brackets are fastened to wood with custom designed tamper-resistant screws with superior holding power while still easily serviceable if the need arises.
- Tops are supported between the leg top tubes and wood with spacers.

Leg Assembly



- Structural leg components are comprised of 1 1/4" diameter, 14-gauge steel tubing.
- Legs and stool columns are constructed of 1 1/4" diameter, 14-gauge steel tubing and braced horizontally to the stool support column on the opposite side of the table to resist bending.

Lock Rod



- Heavy duty 7/16" diameter lock rod is chrome plated to resist wear.
- Tamper resistant lock nuts on all down lock assemblies with a self-adjusting hinge lock ensure that the down lock engages every time.

Storage Lock

- Heavy duty storage lock is comprised of a 1 1/4" square tube with heavy-duty catch. Locks automatically in storage position and easily release from either side of the table when opening.

Table Top & Seats

Core



- Available in MDF, Particleboard, or Plywood.
- Tops and benches are surfaced with high pressure laminate bonded to a 3/4" thick AC grade core, sealed underneath with a poly backer for T-molded tabletops and a phenolic backer sheet for tabletops with Protect Edge. This is especially helpful when cleaning the underside of the table.

Edge (for table tops and benches)



- Available with Protect Edge or Vinyl T-Molding.
- Protect Edge is sealed with a polyurethane epoxy resin, chemically bound to the edge of the laminate, core and phenolic backing sheet.
- Vinyl T-molding is secured by staples to the top's underside approximately every 10".

Seat

Stools



- Stools are injection molded with a minimum of 25 Oz. of rubber-modified, high impact polystyrene materials measuring 13" in diameter.
- Ribs, which extend from the outer perimeter of the stool to the mounting hub in the center, are reinforced to resist failure with 12 integrally molded, tapered ribs.



- **Wobble-free** stools are mounted quickly without "wobble" with our custom designed serrated head nut and bolt. Nut also has nylon locking inserts to ensure stools stay tight.
- Power tools are recommended for safe and secure assembly.

ADVANTAGES & BENEFITS for NPS Mobile Tables pages 112-129

Frame Design | Table Top | Seat

Hardware

Table Top Screws



- Serrated head and thick threading provides superior holding power to frame with the ability to be serviced easily in the field.
- Tamper resistant.

Flower Glides and Tube Closures

- Made from glass-infused nylon and spring steel, will not break or fall out.

Casters



- 4" heavy-duty, double ball-bearing casters.
- Weight capacity of 275 lbs. per castor.
- Hard rubber, non-marring wheels.

Operation

Entrances (for bench units)

- Each bench is designed for easy entry on both ends.

Locking - Opening



- A gravity lock automatically locks the table in the open position. The lock is disengaged manually, capable of being operated from both sides of the table.

Locking - Folding



- The storage lock latch automatically locks the table in the folded storage position. The lock is disengaged manually, capable of being operated from both sides of the table and within easy reach.

Custom Torsion Bar System



- Easy opening and closing via a perfectly balanced torsion bar system.
- Each unit includes 1 to 5 torsion bars determined by table size and core material.
- Each torsion bar is at a specific angle based on weight distribution.

Safety

Lift-Off Casters



- Mobile tables incorporate the beneficial castor lift-off design in which casters lift off the floor in the open position.
- Lift-off casters do not protrude past the seats so they are not a tripping hazard.

Midway Position Lock



- Secures the unit in a partially folded position for ease of movement during floor cleaning and to prevent finger or hand pinching.

Storage Lock Latch



- Vertical adjustment ensures that the table always locks safely into the folded position.
- **UL CERTIFIED:** Tested for 7,000 open/close cycles exceeding the UL testing standard of 6,000 cycles.
- **SAFETY POSITION:** Folds in teepee position to prevent tipping.

CAFÉ



Bushwick Bentwood Chairs & Stools

Bentwood Chair

Bentwood Barstool



Model Number Configuration



Model	Width	Depth	Back Height	Seat Height	Back Height
Chair	21 ½"	22 ¼"	33 ⅞"	18"	N/A
Bar Stool	21 ½"	22 ¼"	46 ½"	30"	13 ½"



Features



Heavy-Duty Bumpers for Safe and Secure Stackability



Modern Handle for Easy Movement and Storage



4 Fully Welded 12-Gauge Under-Seat Support Brackets



½" Thick 8-Layer Bent Plywood Seat With HPL Finish



Legs Designed for Easy Stackability

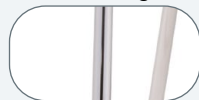

7/8" 16-Gauge Chromed Steel Tubing



Designer Contoured Waterfall Edge



Durable Non-Marring Polypropylene Glides

Colors



Espresso (21)

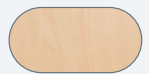

Natural (22)

Barstool



Heavy-Duty Welded Footring for Added Comfort and Stability

CAFÉ | CT SERIES
Fixed Height Tables



Features



Industrial Grade
8-Gauge Steel
Bases



Pole Connects to Base
With Heavy-Duty Bolt
and Thread Locker



Poles Have a 3"
Diameter and a Fully
Welded Base Plate



Leveling Glides
Pre-Installed to
Bases



Poles Feature a Fully
Welded Tabletop
Support Plate



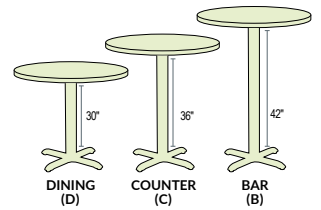

THREE HEIGHTS AVAILABLE

Tabletops



1.2" Particleboard core
HPL Surface
T-molding
(PBTM)

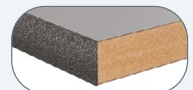

1.2" MDF core
HPL Surface
Protect Edge
(MDPE)



1.2" Particleboard core
Whiteboard Surface
PVC Edge Banding
(WB)



Quick ship options available

Frame Colors



Black
(no Code)



Soft Grey
(G)

Base Style



T Base
(T)



X Base
(X)



Round Base
(R)

Model Number Configuration

Prefix Shape Size Height Tabletop
CTG 2 3042 T D PBTM xx
 Color (if Grey) Base Style Laminate (HPL Tops)

Shapes



Round
(1)



Rectangle
(2)



Square
(3)



Racetrack
(4)



Curve
(5)

Rectangle & Racetrack Sizes (width/Length in inches)

2430	2436	2442	2448	2454	2460	2472	2484	2496
3036	3042	3048	3054	3060	3072	3084	3096	

Round & Square Sizes

(width/Length in inches)	
2424	3030
3636	4242
4848	

Curved Sizes

(width/Length in inches)	
60°: 2491*	108°: 2492*



products meet or exceed applicable ANSI/BIFMA standards

Quick ship tables available in 36" round and square, choose from Grey Nebula (GY) or Figured Mahogany (MY) laminates with Black T-mold (TM)

*Recommended with T Base

CAFÉ | PCT SERIES
Premium Plus Café Table



Features



Four Locking Heavy Duty Non-Marring Swivel Casters



Heavy-Duty 13-Gauge Steel Column



1/2" Thick Solid Steel Base



Easy Pneumatic Height Adjustment





Easy To Use Non-Pinching Handle



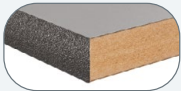

Tabletop Options

			
1.2" Particleboard core HPL Surface T-molding (PBTM)	1.2" MDF core HPL Surface Protect Edge (MDPE)	1.2" Particleboard core Whiteboard Surface PVC Edge Banding (WB)	1 ½" Blow Molded Top (BM)

Shapes

 **Round**
 (1)

 **Square**
 (3)

7 DAY QUICK SHIP

Quick ship options available

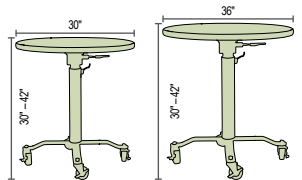

Model Number Configuration



Size (square/round in inches)

24	30	36*
----	----	------------

• Quick ship tables available in this size, choose from tops BM and PB with Grey Nebula (GY) or Figured Mahogany (MY) laminates with Black T-mold (TM)

Standard lead time is 8 weeks.
 Quick ship lead time is 7 days.

*Blowmold top only available in 36" square.

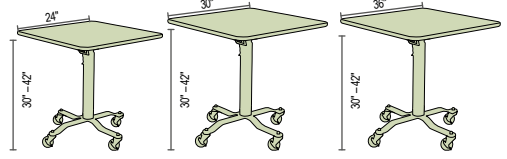







CAFÉ | CTT/CTS SERIES
Café Time



Roll In



Flip



Store



Color



Charcoal Slate
Silver Tone Frame

Table Features



Concealed Pneumatic
Lever Makes for Effortless
Raising and Lowering



Casters and
Glides Included

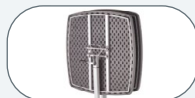

Tabletop Sets Into
Vertical Position For
Compact Storage

Chair Features



Rubber Glides To
Protect Floors



Stacks For
Easy Storage



Scratch Resistant,
Attractive Chair Seats
& Backs

Model# Description

CTT3042	Café Time Adjustable-Height Table
CTS30	Café Time Stool

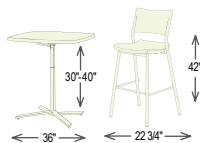





MUSIC

Melody Chair®
8210, TR82



Music Stand
82MS



Conductor
CSS, CP2, CS, CTS



Melody Chair®



Stacks
18
CHAIRS

See Page 173 for Dolly Specs

Compatible with **DOLLY**



DY82

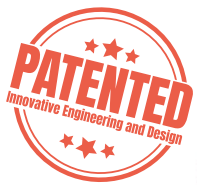

Melody Chair® Jr.

(16" SEAT HEIGHT VS. 17.5" ON THE 8210)

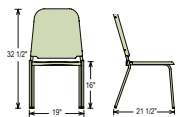

Model Number
8210-16

TWO HEIGHTS AVAILABLE

Model Number
8210

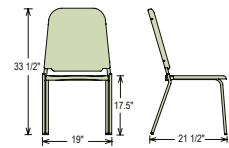

Melody Chair® Features



Optional Tablet Arm With Plywood Core



Durable Polypropylene Contoured Seat For Extra Comfort



Curved, Tight Plugs



Music Band-Pitch Style With a Seat Back Angle Of 97°

Tablet Arms



TA82L Left Tablet Arm



TA82R Right Tablet Arm



products meet or exceed applicable ANSIBIFMA standards



Tuba Rest



NEW

Model Number
TR82

Note: Chair sold separately

Tuba Rest Features



Telescoping Tube with Four Adjustable Height



Quick & Easy Installation



17-Gauge, 7/8" Square Chrome Frame

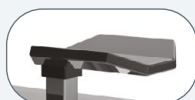

Thermoplastic Coated Tuba Support with Ergonomic Design

Music Stand



Model Number
82MS

2 DAY LIGHTNING SHIP

Music Stand Features



Tension Tilt Surface For Smooth Adjustment



Neck Assembly Provides A Tighter Fit On Pole



Rubber Tips Included To Prevent Noise And Floor Scratching



products meet or exceed applicable ANSI/BIFMA standards

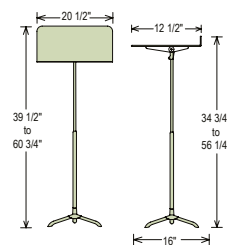

See Page 175 for Dolly Specs
Compatible with **DOLLY**
DYMS10, DYMS20

CONDUCTOR'S FURNITURE



CONDUCTOR'S FURNITURE



CONDUCTOR'S FURNITURE



CONDUCTOR'S FURNITURE



ROOM DIVIDERS



ALUMINUM FRAMING
Encasing Each Panel

**BUILT-IN
MAGNETIC GANGING**



SOUND DAMPENING PET
*Noise Reduction Coefficient of .55
Sound Absorption Average of .54*



ROBUST



EASY



PORTABLE



FULL LENGTH HANDLE
For Easy Manuverability



STEEL FOOT PEDAL
LOCK RELEASE



3/16" ACRYLIC
Frosted and Clear Options

DIVIDERS Robo Dividers



ROLL IN



FOLD



SET UP



GANG



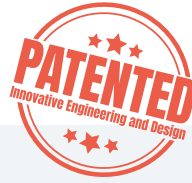

Features



Panel Position Regulators



Full Length Handle



Built-in Magnetic Ganging Mechanism on Top and Bottom



Foot-Pedal Activated Lock-Release Enables Effortless Folding

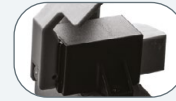

Auto-Click Panel-Locking Mechanism Keeps Panels Secure When Folded



Self-Leveling Spring Mechanism on All Casters



Each Panel Is Encased in Aluminum Framing



Tech-Lock Brake on 3" End-Panel Casters



PET Panels Are Tackable



PET Panels Are B1-Grade Flame Retardant



PET Panels Have a Noise Reduction Coefficient of 0.55 & Sound Absorption Average of 0.54



PET Panels Are Made of Environmentally Friendly Recycled Materials

Divider Lengths

6' Standard height

3 Panels
72"

5 Panels
118"

7 Panels
164"

9 Panels
210"

11 Panels
256"



Panel Type

SOUND ABSORBING PET



Grey (PT02)



Blue (PT04)



Black (PT10)

OPTIX® ACRYLIC

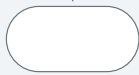

Clear (CA)

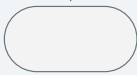

Frosted (FA)

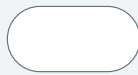

Whiteboard (WB)

Frame Color



Black (B)



Grey (G)

Model Number Configuration

Model Number Panels
RD B 6 3 PT04
Frame Color Panel Type

Base Model # Description

RDB6	Black Frame, 6ft High
RDG6	Grey Frame, 6ft High



7 DAY
QUICK SHIP

Robo Dividers with Sound Absorbing Pet (PT02, PT04 and PT10) and Clear Optix® Acrylic (CA) Panel Type







STAGES AND RISERS

Stages

S, SP, SST, TFXS, SG



Risers

RT, RS, TP,
SBRC, SCRC



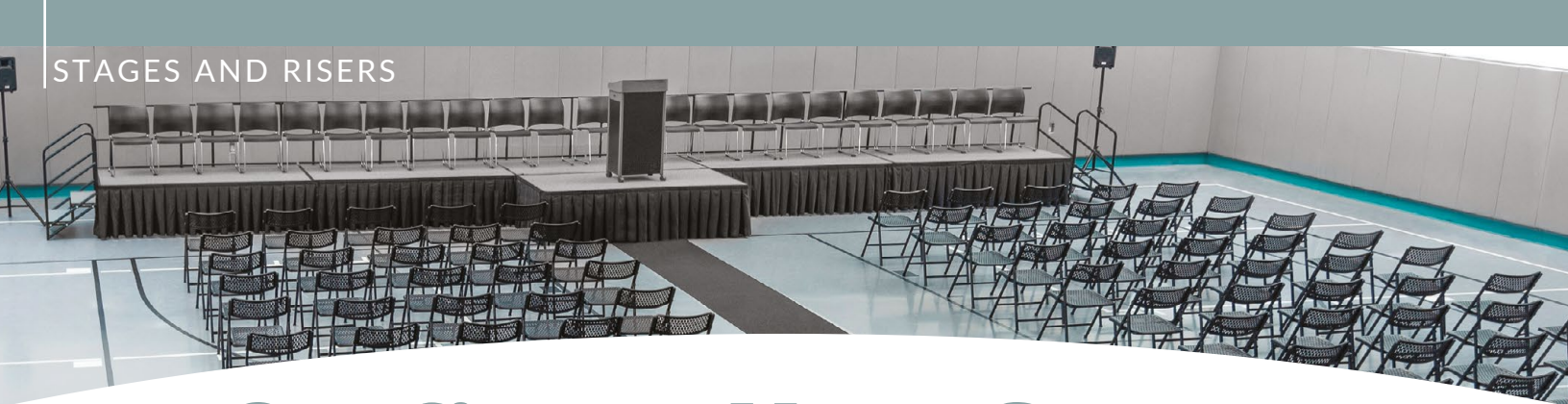

Configure Your Stage

WIDTH, HEIGHT AND SURFACE TYPE



Sizes

WIDTH

36" 48"

HEIGHT

8" 16" 24" 32"

Surface Options

CARPET



Model Number Configuration

Model Number | Height
S488C-10
 Width | Surface

Features



14-Gauge Tubular Steel Legs



16-Gauge Steel Frame

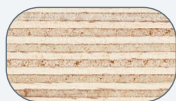

0.75" Thick Plywood Core

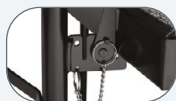

Ganging To Easily Connect Multiple Stages



96" Standard Length

200 LBS/FT²

Tested by SGS Labs to Exceed 200 lb/Sq Ft Weight Capacity



Create Curved Configurations

Using Stage Pies

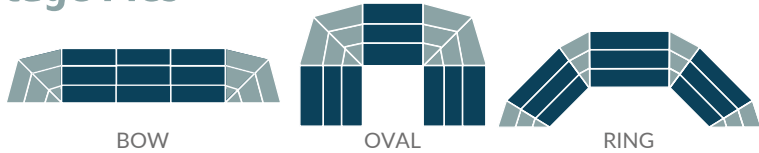

Sizes

WIDTH

36" 48"

HEIGHT

8" 16" 24" 32"

Model Number Configuration

Model Number | Height

SP36 8 C-04

Width/Depth | Surface



Surface Options

CARPET

Black (C-10) | Blue (C-04) | Grey (C-02) | Red (C-40) | Hardboard (HB)

Create Seated Risers

Single-level stages combine with gangers to create multi-level surfaces. Use below configuration codes for multi-level sets.

Straight sets



See Accessories

Page 161

Stage Packages

Page 165

Pie sets



Level Code

2L 2 levels; 8" and 16" Heights

3L 3 levels; 8", 16", and 24" Heights

4L 4 levels; 8", 16", 24" and 32" Heights

Model Number Configuration

Model Number | Width | Level Code

SPST 48 2L C-10

Add "P" for pie set | Surface



Choral Risers

Combine Risers for Straight or Curved Configurations

Straight Edge

Code "RS"



Tapered Edge

Code "RT"

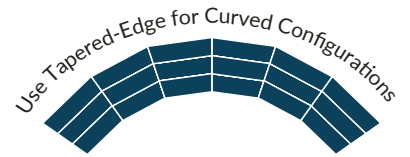

Sizes

WIDTH

18"

HEIGHT

8" 16" 24" 32"

Surface Options

CARPET



Model Number Configuration

Edge Code | Height
RT 24 C-10
 Surface

Single-level risers combine with gangers to create multi-level surfaces. Use below configuration codes for multi-level sets.



Edge Code

STRAIGHT

Code "RS"

TAPERED

Code "RT"

Level Code

2L 2 levels; 8" and 16" Heights

3L 3 levels; 8", 16", and 24" Heights

4L 4 levels; 8", 16", 24" and 32" Heights

Model Number Configuration

Edge Code | Level Code
RS 2L C-10
 Surface



TransPort Riser

Available with straight or tapered edges and a fourth-level add-on

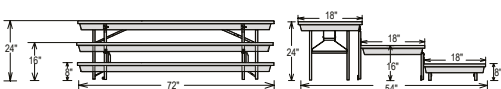

Model Numbers

- TP72 Straight Riser
- TPR72 Tapered Riser
- TPA 4th Level Straight Add-on
- TPRA 4th Level Tapered Add-on

Transfix Stages

Adjustable Height Stages for Built-in Multi-Level Capabilities



Sizes

WIDTH/LENGTH

48"x48"

48"x96"

ADJUSTABLE HEIGHTS

16"/24"

24"/32"

Model Number Configuration

Prefix Width/Length
TFXS 4896 1624 C-10
 Height Surface

Surface Options

CARPET



Black
(C-10)



Blue
(C-04)



Grey
(C-02)



Red
(C-40)



Hardboard
(HB)

Features

**200
LBS/FT²**

Tested by SGS Labs to Exceed 200 lb/Sq Ft Weight Capacity



2 Heavy Duty Casters Lift Off When Set Up



14-Gauge Legs Adjustable to Two Heights



Built in Gangers for Multi Stage Configurations

See Accessories



Page 161



Stage Packages

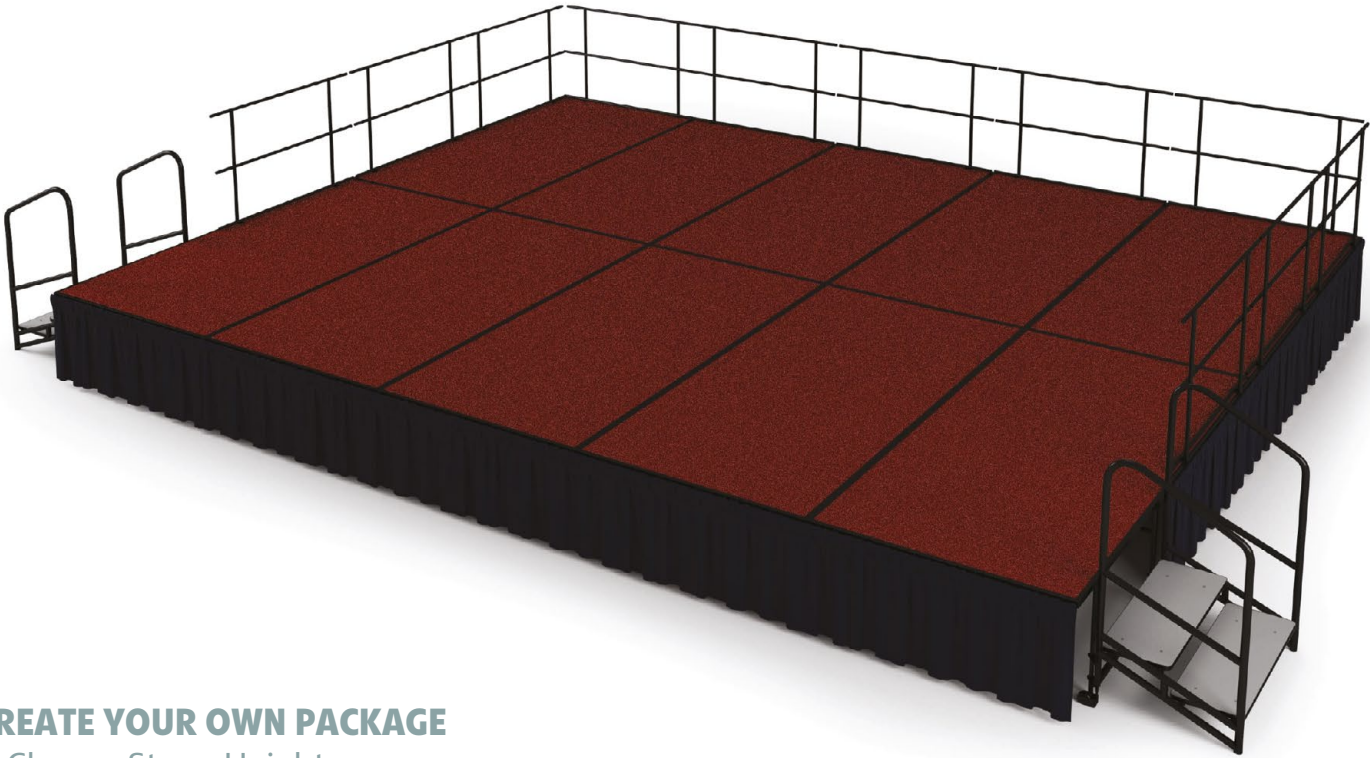

CREATE YOUR OWN PACKAGE

1. Choose Stage Height
2. Choose Quantity of Stages
3. Choose Surface Type and Color
4. Choose Skirting Type and Color

WE WILL CONFIGURE THE REST.

Each package includes guard rails on 3 sides, skirting on all sides, and 2 sets of steps.

Skirting Options

Type



Box pleat skirting (SB)



Shirred pleat skirting (SS)

Color



Black (10)



Navy (04)



Burgundy (08)



Green (06)

Surface Options

CARPET



Black (C-10)



Blue (C-04)



Grey (C-02)



Red (C-40)



Hardboard (HB)

Model Number Configuration

Prefix | QTY of Stages | Skirting Color
SG48 24 04 C-10 -SB 08
 Height | Surface | Skirting Type

Sample Configurations

Model#	Description	Add surface and skirting codes to the end of Model #
SG482404	16' X 8' X 24"	
SG481610	20' X 16' X 16"	
SG482410	20' X 16' X 24"	
SG483210	20' X 16' X 36"	
SG482412	24' X 16' X 24"	
SG362404	12' X 8' X 24"	



Riser Packages

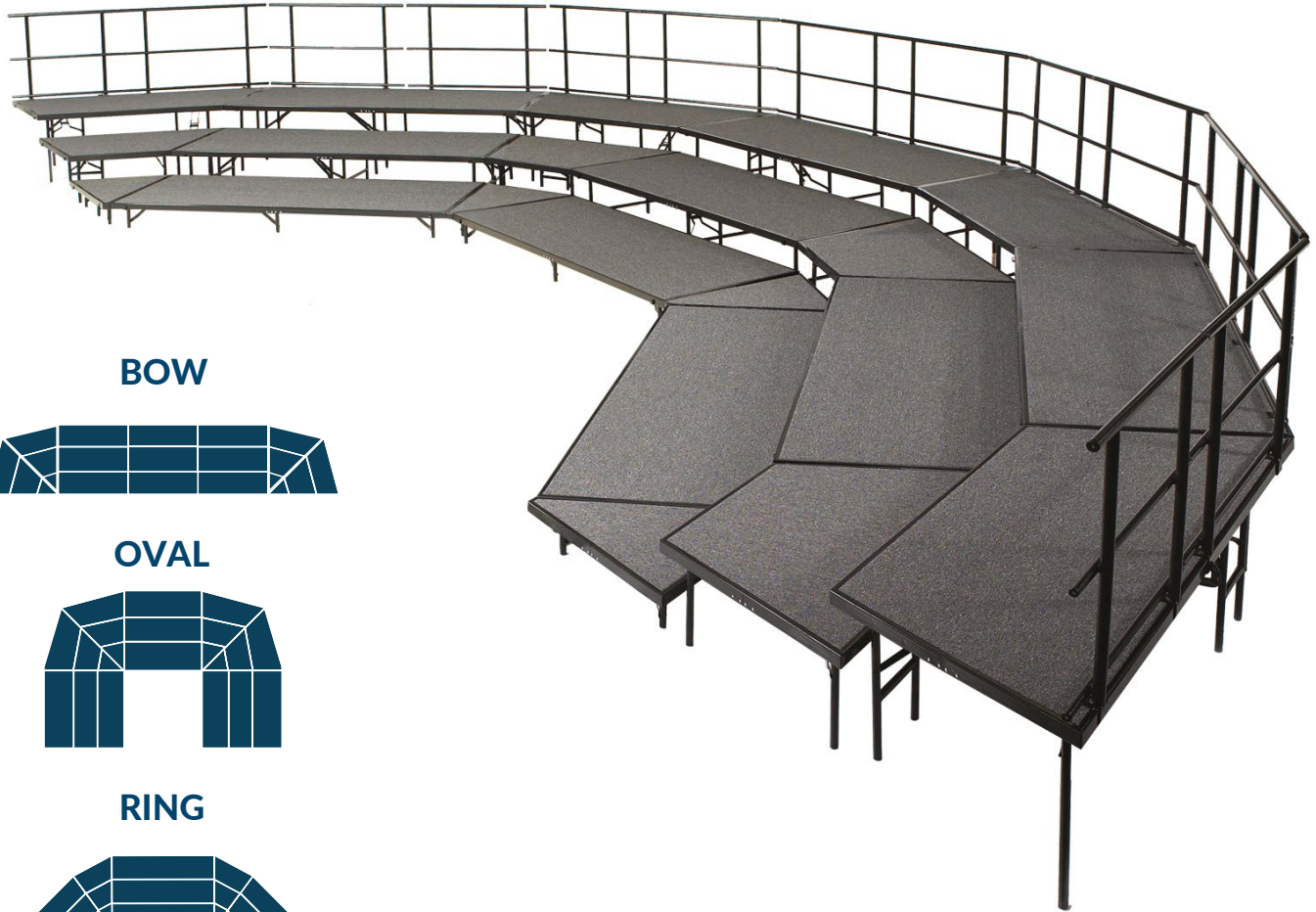

BOW



OVAL

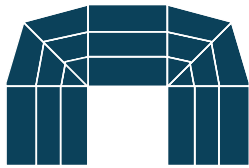

RING



Surface Options

CARPET



Use progressive heights for Seated Bands or Choral Riser Configurations

Package Options

Model#	Includes
SBRC48	3 sets of SST48 (48" x 96" straight stages) and 4 sets of compatible SPST48 (pie stages) and guard rails
SBRC36	3 sets of SST36 (36" x 96" straight stages) and 4 sets of compatible SPST36 (pie stages) and guard rails

Model Number Configuration

Base Model

SBRC48 C-10

Surface Option



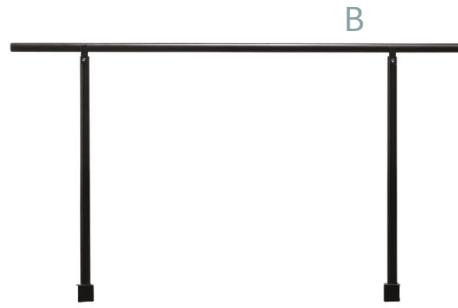

A. Back Guard Rail For use with choral risers

Model#	Description
GRR24S	Back Guard Rails for 3 Level Straight Standing Choral Risers
GRR32S	Back Guard Rails for 4 Level Straight Standing Choral Risers
GRR24T	Back Guard Rails for 3 Level Tapered Standing Choral Risers
GRR32T	Back Guard Rails for 4 Level Tapered Standing Choral Risers
GRTPR3	Back Guard Rails for 3 Level TransPort Riser
GRTPR4	Back Guard Rails for 4 Level TransPort Riser

B. Side Guard Rail For use w/ standing risers in 3 heights

Model#	Description
SGRTP3	Side Guard Rails for 3 Level TransPort Riser
SGRTP4	Side Guard Rails for 4 Level TransPort Riser
SGR2L	Side Guard Rails for Standing Choral Risers
SGR3L	Side Guard Rails for Standing Choral Risers
SGR4L	Side Guard Rails for Standing Choral Risers

Chair Guard

Model#	Description
CG28	Chair Guard for SP368 Stage Pie
CG32	Chair Guard for Sides of 3' x 8' Stages
CG37	Chair Guard for SP488 Stage Pie
CG44	Chair Guard for Sides of 4' x 8' Stages
CG54	Chair Guard for SP3616 & SP4824 Stage Pie (2 EA. Needed for SP4824)
CG72	Chair Guard for SP4816 Stage Pie
CG81	Chair Guard for SP3624 Stage Pie
CG96	Chair Guard for Back of Stages (3' x 8' & 4' x 8')

C. Dolly For use with stages & seated risers (Minimum 36" widths)

Model#	Description
SDL	Stage Dolly for Use with 36" W or 48" W Stages

D. Steps For stages in 3 heights

Model#	Description
STP16	Steps for 16"H Stages
STP24	Steps for 24"H Stages
STP32	Steps for 36"H Stages

E. Stage Guard Rail For use with stages

Model#	Description
GRS30	30"W Guard Rail for Stages
GRS36	36"W Guard Rail for Stages
GRS48	48"W Guard Rail for Stages

Skirting Options

Model Number Configuration



Skirting Type



Box pleat skirting (SB)



Shirred pleat skirting (SS)

Size



Skirting Color



Black (10)



Burgundy (08)



Green (06)



Navy (04)



DOLLIES



TAD National Public Seating
TABLES
GETTING UP YOUR TABLE IS ALWAYS EASY!
www.nationalpublicseating.com | 800-284-4137

SAFETY INSTRUCTIONS
WARNING: Read carefully before using. Do not use if damaged or if parts are missing. Do not use if you are unable to lift or move the table safely. Do not use if you are unable to follow the instructions. Do not use if you are unable to lift or move the table safely. Do not use if you are unable to follow the instructions. Do not use if you are unable to lift or move the table safely. Do not use if you are unable to follow the instructions.

Transport Options

For use with 4', 5', 6' or 8' rectangular tables

SETTING UP YOUR TABLE IS AS EASY AS 1-2-3

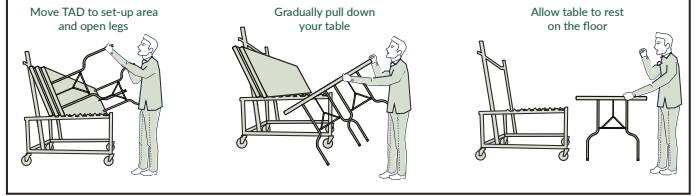

Features



Plastic Coated Table Support Frames



4 Swivel / 2 Locking Casters



7/8" O.D. Steel Handle (18-Gauge)



5 X 1.25" Hard Rubber Casters



1" Square 14-Gauge Tubular Frame

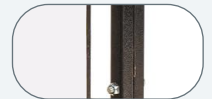

Textured Black Powder-Coated Steel

Compatible Table Series

BT1800 BT2400 BT3000 MSFT*

*Rectangle tables only

Quantity of Tables

10 5

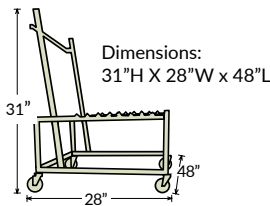

Storage and Transport Dollies

DYMU

Equipped with a Center Bar To Support Small Table Sizes



Compatible Table Series

BT2400 BT3000 BT48R BT60R

Quantity of Tables 8-10

DY-71R

Equipped with an Extra Bar For Additional Support



Compatible Table Series

BT48R BT60R BT71R

Quantity of Tables 8-10



DY-60R

Equipped with a Tubular Handle For Stability & Easy Handling



Compatible Table Series

BT48R BT60R

Quantity of Tables 8-10

DY-3072

Tables up to 72" long

DY-3096

Tables up to 96" long



Compatible Table Series

All Rectangular

Quantity of Tables 12



products meet or exceed applicable ANSI/BIFMA standards

DOLLIES | 84/42-8/EXT-8/C-60 SERIES Storage and Transport Dollies

Model 84

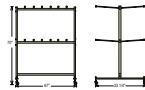

Compatible Chair Series

50 200 300 800 1200 1300 2200 2300

Quantity of Chairs **84**

Model 42-8

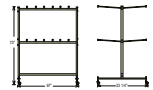

Compatible Chair Series

50 200 300 **600** 800 1200 1300 1400 2200 2300

Quantity of Chairs **42** **30**

Compatible Table Models

BT3072 BT3096

Quantity of Tables **8-10**



Model 84/EXT-8

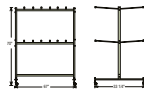

Compatible Chair Series

600 1100 1400 3200

Also any chairs compatible with 84

Quantity of Chairs **72** **60** **96**

Model 84-60 | 84/EXT-8-60 | 42-8-60

Convert the top level of your dolly into a coat rack by adding -60 to the end of the model number



Available Accessories

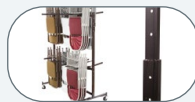

EXT-8

Available for model 84



MODEL C-60

Available for Model 84/42



products meet or exceed applicable ANSI/BIFMA standards



Storage and Transport Dollies

DY-35



USCDK Use this handle kit DY35 and DY50 for understage storage



DY-50

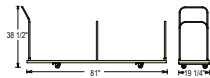

Compatible Chair Series

50	200	300	600	800	1100	1200	1300	2200	2300	3200
----	-----	-----	-----	-----	------	------	------	------	------	------

Quantity of Chairs

24	28	35	30
----	----	----	----

Compatible Chair Series

50	200	300	600	800	1100	1200	1300	2200	2300	3200
----	-----	-----	-----	-----	------	------	------	------	------	------

Quantity of Chairs

35	40	42	50
----	----	----	----



DY1100



DY1400

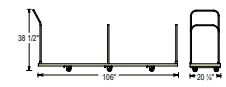
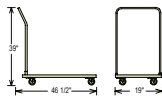

Compatible Chair Series

1100

Quantity of Chairs

26

Compatible Chair Series

1400

Quantity of Chairs

52



products meet or exceed applicable ANSI/BIFMA standards

DOLLIES | DY700/800/DY81/DY82/DY85 SERIES
Storage and Transport Dollies

DY700/800



Optional Strap Available Model DYS8

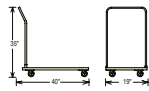

Compatible Chair Series

800

Quantity of Chairs

36

DY81



Compatible Chair Series

8100 BCC

Quantity of Chairs

10

4-6



DY82



Compatible Chair Series

8210 8210-16

Quantity of Chairs

18

DY85



Compatible Chair Series

8500

Quantity of Chairs

40



Storage and Transport Dollies

DY87



Compatible Chair Series

8700 8800

Quantity of Chairs 35

DY87B



Compatible Chair Series

8700B 8700C 8800B 8800C

Quantity of Chairs 24



DY-9000



Compatible Chair Series

9100 9200 9300 BCC

Quantity of Chairs 8-10 4-6

DY86



Compatible Chair Series

8600

Quantity of Chairs 20



products meet or exceed applicable ANSI/BIFMA standards



DOLLIES | DYCL-85/SDL/DYMS10/DYMS20 SERIES
Storage and Transport Dollies

DY-CL85



Compatible Chair Series

850-CL

Quantity of Chairs

30

SDL



Compatible Stages

36"W 48"W

Quantity of Stages

6



DYMS10



Compatible Music Stands

82MS

Quantity of Stands

10

DYMS20



Compatible Music Stands

82MS

Quantity of Stands

20







LECTERNS

Lecterns

GSL, 22, 112, 222, 70,
600, 401S, 611, 612



Sound Lecterns

ZED, GSL-S, 111PLS,
800x, 6010, 950/901



Greystone Lectern



ELEGANT

Designer curved grey plywood for a more sophisticated look.



VERSATILE

Steel cabinet and hooded twin wheel matching casters allow for added storage and mobility.



MULTI-MEDIA

Large reading surface and pull-out shelves for a complete multi-media presentation experience.



Features



Sleek Grey Plywood Provides A Smooth Writing Surface



Quality Lock For Secure Storage



3" Twin Wheel TPR Two-Tone Casters



Two Shelves and Drawer for Convenient Storage

GSL SERIES GREYSTONE LECTERN

Reading Surface: 22.75"W x 18.25"D
Side pull out trays (R & L): 14.25"W x 12"D
Front pull out tray: 17.5"W x 9.25"D
Top two cabinet shelves: 21"W x 14.75"D x 7"H
Bottom cabinet shelf: 21"W x 14.75"D x 12"H
Drawer: 6.25"W x 15"D x 13.25"H
Product Weight: 89 lbs.



Full Floor Lectern
222 Series



TableTop Lectern
22 Series



Lectern Base
112 Series



222 SERIES

Colors



Mahogany
222-MY

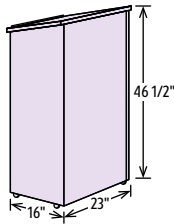

DIMENSIONS: 46.5"H
X 23"W X 16"D
WEIGHT: 56 LBS.

22 SERIES

Colors



Mahogany
22-MY



Black
22-BK

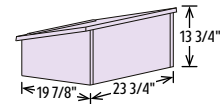

DIMENSIONS:
13.75"H X 23.75"W X 19.875"D
WEIGHT: 31 LBS.

Features



Built in Paper/
Bookstop



Convenient
Shelf for Storage

Accessories



2CS
Caster Kit
Optional for 222
included with 112

112 SERIES

Color



Black
112-BK

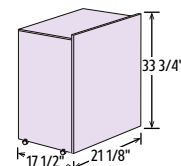

DIMENSIONS: 33.75"H
X 21.125"W X 17.5"D
WEIGHT: 50 LBS.



Portable Presentation Lectern
70 Series



Aristocrat Floor Lectern
600 Series



2 DAY
LIGHTNING SHIP

ten year
warranty
10

Features



Adjustable Height
From 30" - 44" and
Adjustable Glides



Features a
Generous 20"Wx16"L
Reading Surface

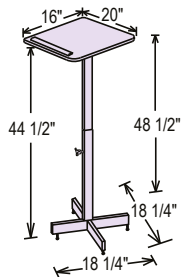

Colors



Medium Oak
70-MO



Mahogany
70-MY



Wild Cherry
70-CH

Features



4 Easy-Roll
Casters, 2
Locking



Side Mounted Slide
Out 15"Wx16"L Shelf
For A/V Presentation
Equipment

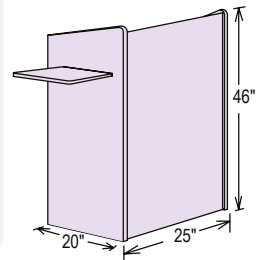

Colors



Medium Oak
600-MO



Mahogany
600-MY



Wild Cherry
600-CH

Clear Acrylic Podium 401S Series



Model Number
401S

Features



Features a
Convenient Shelf



Broad 23.5"X24"
Reading Surface



Built-in Acrylic
Book Stop

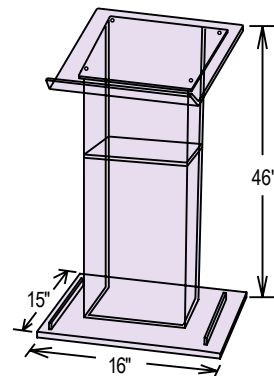

Vision LECTERNS

Vision Lectern
611 Series



Vision Lectern with Screen
612 Series



611 SERIES

Color



Ribbonwood
611-RW

Features



Four Concealed
Casters, Two Locking

Overall Dimensions: 46"Hx24"Wx21"D
Interior shelf: 14.5"Dx23"W



612 SERIES

Color



Ribbonwood
612-RW

Features



Screen Display Is
Compatible With All Popular
SD Memory Cards. No
Computer Necessary



3/4-Inch Stain and
Scratch Resistant
Thermofused Melamine
Laminate on MDF



Easy to Use
Remote Control
Operation With
On Screen Menus



Sleek Black Casing
Around LCD Display



SOUND LECTERNS

ZED Lectern

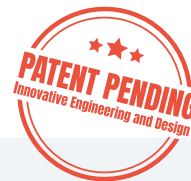

Features



Equipped With Condenser and Dynamic Microphone Inputs



Includes One Gooseneck Mic and One Tie-Clip/Lavalier Mic



Amplifier Supports Bluetooth/USB Inputs



Built-in Tone Control Capabilities



Output Lines for Auxiliary Speakers



Featuring 4 Concealed Casters



Equipped With a Halogen Lamp



Four 4" 40W Speakers



Durable Scratch Resistant Surface



High-Pressure Thermal-Fused Laminate on an MDF Core

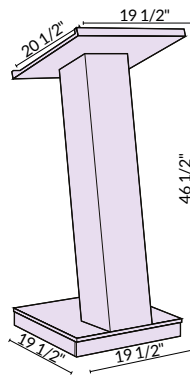

Product Feature	ZED
Overall	19.5"W x 19.5"D x 46.5"H
Reading Surface	19.5"W x 20.5"D
Product Weight	47.6 lbs.
Mics	21" Gooseneck
AMP	40W



LECTERNS | GSL-S SERIES
Greystone Lectern with Sound

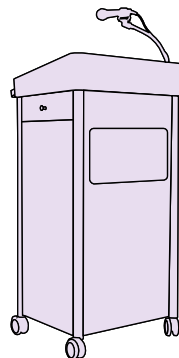

Features



Includes a Handheld Mic With 9' Cable and a Tie-Clip/Lapel Mic With 10' Cable



Equipped With Condenser and Dynamic Microphone Inputs



Amplifier Supports Bluetooth/USB Inputs and Output Lines for Auxiliary Speakers



Sleek Grey Plywood Provides A Smooth Writing Surface



Two Shelves and Drawer for Convenient Storage



3" Twin Wheel TPR Two-Tone Casters

Product Feature	GSL-S
Overall	23.5"W x 19.25"D x 45.5"H
Reading Surface	22.75"W x 18.25"D
Side Pull Out Trays (R & L)	14.25"W x 12"D
Front Pull Out Tray	17.5"W x 9.25"D
Top Two Cabinet Shelves	21"W x 14.75"D x 7"H
Bottom Cabinet Shelf	21"W x 14.75"D x 12"H
Drawer	N/A
Product Weight	95 lbs.
Mics	Handheld and Tie-clip
AMP	30W

Optional Suffix	Description
/LWM-5	Add Wireless Handheld Mic
/LWM-6	Add Wireless Tieclip Mic
/LWM-7	Add Wireless Headset Mic

Optional Prefix	Description
M	Add Rechargeable Battery

**Power Plus Lectern
111PLS Series**

**The Orator
800X Series**





Color

Mahogany
111PLS-MY

Ribbonwood
111PLS-RW

Color

Mahogany
800X-MY

Ribbonwood
800X-RW

Upgraded Amplifier with Bluetooth/USB Inputs

Upgraded Amplifier with Goosneck Microphone and Four Concealed Casters

Base Model	Description
111PLS-MY	Power Plus Lectern - Mahogany
111PLS-RW	Power Plus Lectern - Ribbonwood

Base Model	Description
800X-MY	Orator Lectern - Mahogany
800X-RW	Orator Lectern - Ribbonwood

Optional Suffix	Description
/LWM-5	Add Wireless Handheld Mic
/LWM-6	Add Wireless Tieclip Mic
/LWM-7	Add Wireless Headset Mic

Optional Suffix	Description
/LWM-5	Add Wireless Handheld Mic
/LWM-6	Add Wireless Tieclip Mic
/LWM-7	Add Wireless Headset Mic

Optional Prefix	Description
M	Add Rechargeable Battery

Optional Prefix	Description
M	Add Rechargeable Battery

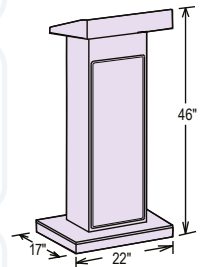
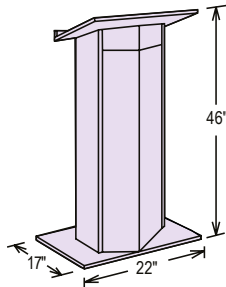



Base Model	Description
6010-MY	Aristocrat Floor Lectern - Mahogany

Optional Suffix	Description
/LWM-5	Add Wireless Handheld Mic
/LWM-6	Add Wireless Tieclip Mic
/LWM-7	Add Wireless Headset Mic

Optional Prefix	Description
M	Add Rechargeable Battery

Color



Mahogany
6010-MY

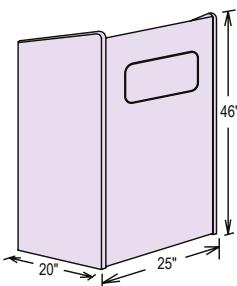

See Accessories

 Page 189

2 DAY
 LIGHTNING SHIP

ten year
 warranty
10

Veneer Lecterns

Combo Veneer Sound Lectern 950/901 Series



Upgraded Amplifier with Bluetooth/ USB Inputs Goosneck Microphone and Four Concealed Casters

Base Model	Description
950/901-MY/WT	Combo Floor Sound Lectern - Mahogany on Walnut

Optional Suffix	Description
/LWM-5	Add Wireless Handheld Mic
/LWM-6	Add Wireless Tieclip Mic
/LWM-7	Add Wireless Headset Mic

Optional Prefix	Description
M	Add Rechargeable Battery

Color

Mahogany on Walnut
950/901-MY/WT

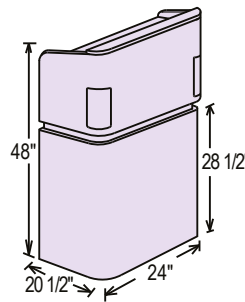



	111PLS	6010	800X	950 / 901	GSL-S	Zed
Dimensions	46"H X 22"W X 17"D	46"H X 25"W X 20"D	46"H X 22"W X 17"D	48"H X 24"W X 20"D	45.5" H X 23.5" W X 19.25" D	46.5" H X 19.5" W X 19.25" D
Weight	50 Lbs.	89 Lbs.	63 Lbs.	175 Lbs.	95 Lbs.	47.6 Lbs
Inside Shelf	20.5"W X 6"D	(2) 23.5"W X 18"D	12"W X 4"D	22"W X 16"D X 11"H	21"W X 14.75"D X 7"H	–
Microphones	2 Condenser Type: Handheld W/ 9' Cable; Tie-Clip Lavalier With 10' Cable	2 Condenser Type: Handheld W/ 9' Cable; Tie-Clip Lavalier With 10' Cable	1 Gooseneck Mic; One Tie-Clip/Lavalier Mic	1 Gooseneck Mic; One Tie-Clip/Lavalier Mic	2 Condenser Type: Handheld W/ 9' Cable; Tie-Clip Lavalier With 10' Cable	1 Gooseneck Mic; One Tie-Clip/Lavalier Mic
Speakers	Four 8" Full Range	Two 8" High Efficiency	Four 6" Full Range	Four 4" High Efficiency	Two 8" High Efficiency	Four 4" High Efficiency
Inputs	Two Mics, One Aux	Two Mics, One Aux	Two Mics, One Aux	Two Mics, One Aux	Two Mics, One Aux	Media Players, Extension Speakers, Usb, Bluetooth, Recording & Mp3
Wireless	Switchable; Two Frequency	Switchable; Two Frequency	Switchable; Two Frequency	Switchable; Two Frequency	Bluetooth Enabled	Bluetooth Enabled
Outputs	Line Out 1 – Extension Speaker Line Out 2 – Media Recorder	Line Out 1 – Extension Speaker Line Out 2 – Media Recorder	Line Out 1 – Extension Speaker Line Out 2 – Media Recorder	Line Out 1 – Extension Speaker Line Out 2 – Media Recorder	Line Out 1 – Extension Speaker Line Out 2 – Media Recorder	Line Out 1 – Extension Speaker Line Out 2 – Media Recorder
Controls	Four Volume, Bass/ Treble, On/Off	Four Volume, Bass/ Treble, On/Off	Four Volume, Bass/ Treble, On/Off	Four Volume, Bass/ Treble, On/Off, Bluetooth/Usb	Four Volume, Bass/ Treble, On/Off, Bluetooth/Usb	Four Volume, Bass/ Treble, On/Off, Bluetooth/Usb
Fuse	Internally Mounted, 2a	Internally Mounted, 2a	Internally Mounted, 2a	Internally Mounted, 2a	Internally Mounted, 2a	Internally Mounted, 2a
Power Supply	117 Volt Ac; 12 V Dc W/Optional Battery	117 Volt Ac; 12 V Dc W/Optional Battery	117 Volt Ac; 12 V Dc W/Optional Battery	117 Volt Ac; 12 V Dc W/Optional Battery	117 Volt Ac; 12 V Dc W/Optional Battery	117 Volt Ac; 12 V Dc W/Optional Battery
Recharger	Internally Mounted; W/Led Indicator	Internally Mounted; W/Led Indicator	Internally Mounted; W/Led Indicator	Internally Mounted; W/Led Indicator	Internally Mounted; W/Led Indicator	Internally Mounted; W/Led Indicator
Screen	–	–	–	–	–	–
Supported Formats	–	–	–	–	–	–

Available Accessories for Sound Lecterns



LWM-5
Wireless Handheld Mic



LWM-6
Wireless Tie-Clip/Lavalier Mic



LWM-5
Wireless Handheld Mic



PS12V
12V 5 Amp Rechargeable Battery

Model Number Configuration

Lectern Model Number Accessory Code

800XRW LWM-5

add "M" prefix to model number for rechargeable battery

PRESENTATION CARTS



The Wizard Lectern
WZD Series



Features



Surfaces Simultaneously Support: Doc Camera, LCD Projector, and Laptop



Attractive Cherry Wood Top & Base With Steel Cabinet



Sliding/ Locking LCD Projector Shelf



Storage Cabinet With Built in Power Strip

Product Feature WZD

Overall Dimensions	38"H x 25"W x 19"D
Boxed Dimensions	37"H x 25"W x 8"D
Surface Dimensions	25"W x 19"D
Laptop Shelf	16"W x 13"D
Side Shelves	16"W x 16"D
Drawer	15"W x 15"D x 2.5"H
Cabinet	23"H x 18"W x 16.5"D
Cabinet Shelf	18"W x 16.5"D
Weight	Unit 88 lbs / Boxed 99 lbs

Color

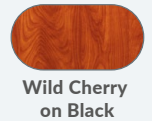

Wild Cherry on Black



Multi Media Cart
MMC Series



Features



Dual Flip up Shelves on Both Sides for Use of a Document Camera, Laptop and Projector Simultaneously

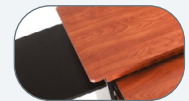

High Pressure Thermofused Scratch Resistance Laminate on Particle Board Core



Locking Door and Drawer for Secure Storage



Front Slide-Out Laptop Shelf

Product Feature MMC

Top Surface	18" L x 21" W
Inside Dimensions	16" L x 14.5" W x 20" H
Projector Slide	16" L x 14" W
Built-In Drawer	10" L x 14" W x 5" H
Height	40" H
Side Pop-Up Shelf	14" L x 14" W

Color

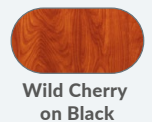

Wild Cherry on Black

Premium Presentation Carts

Premium Presentation Cart
PRC200 Series



Premium Plus Presentation Cart
PRC250 Series



Features



Wire Management Grommets



6 Outlet Power Strip With 25' Cord With Winder



3" Casters (2 Locking)



Large Projector Shelf



Inner Shelf for Added Storage



Adjustable Height Laptop Shelf For Sitting Or Standing Position

Color



Ivory Woodgrain

Product Feature PRC200/PRC250

Dimensions	40.5"H x 18"W x 30"D
Top Shelf	18"W x 16.75"L
Laptop Shelf	18"W x 14"D
Middle Projector Shelf	16"W x 12"D
Bottom Shelf	18"W x 18"D
Weight	40 lbs
Carton size	37"L x 18"W x 5"H
Class	85
Color	Frame: Black; Shelves: Ivory wood grain
Steel	18 gauge
Paint	3 mil powder coating
Tops	Laminated on 3/4" MDF

PRC200

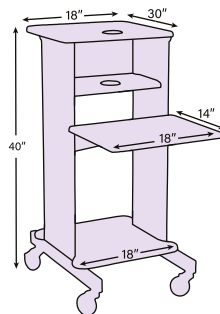

PRC250

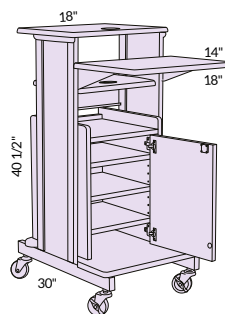

Premium Plus



Lockable Cabinet With 3 Adjustable / Removable Shelves



PRESENTATION CARTS | PRC400/PRC450 SERIES
Jumbo Presentation Carts

Jumbo Presentation Cart
 PRC400 Series

Jumbo Plus Presentation Cart
 PRC450 Series



Features

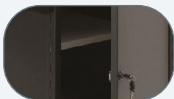

Spacious Lockable Cabinet With Adjustable Shelf



Adjustable Height Laptop Shelf for Sitting or Standing Position

Jumbo Plus



CPU Holder



6 Outlet Power Strip With 20-Foot Cord



Adjustable Height Side Shelf for Document Camera or Projector

Color



Ivory Woodgrain

Product Feature PRC400

Dimensions	40"H x 33"W x 21"D
Surface Dimensions	27"D x 21"W
Middle Projector Shelf	30.5"D x 17.5"W
Laptop Adjustable Shelf	21"W x 18"D
Locking Cabinet	25"D x 19"W x 24.75"H
Cabinet Adjustable Shelf	20"D x 19"W
Weight	100.5 lbs

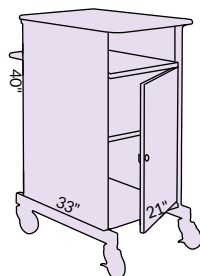

Product Feature PRC450

Dimensions	40"H x 33"W x 21"D
Surface Dimensions	27"D x 21"W
Middle Projector Shelf	30.5"D x 17.5"W
Laptop Adjustable Shelf	21"W x 18"D
Side Adjustable Shelf	24.5"W x 18"D
Locking Cabinet	25"D x 19"W x 24.75"H
Cabinet Adjustable Shelf	20"D x 19"W
Weight	117.5 lbs

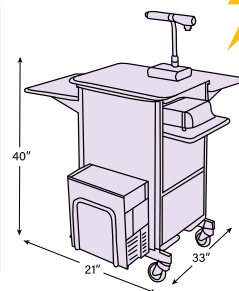

CHARGING CARTS

DUET CHARGING CART DCC Series



Model Number
DCC

Overall Dimensions: 28 1/8"W x 22"D x 38 1/4"H
Surface Dimensions: 22 3/4"W x 21 1/8"D
Shelf Dimensions: 22 1/4"W x 15 1/2"D



Features



18-Gauge Heavy-Duty Steel Parts



4 Heavy-Duty 4" Casters, 2 Locking



Fits 32 Laptops and Tablets With Screens up to 15.6" (up to 1" Thickness)



Adjustable Height Shelves Can Be Adjusted in 2" Increments



32 UL Approved Outlets on Built-in Power Strips



12ft Power Cord to Plug Into Wall



Maintenance Area With 4 Storage Shelves for Device Adapters



Dividers Can Be Positioned at Any Width in 1" Increments



Built in Wire Channels on Each Divider



2 Point Locking System on Front and Back Doors



Hook to Wrap the Power Cord on the Side of Cart



Grip-Rite Surface on Top of Cart

ITALIAN FOOD
Mini

BEST Pizza

STARTERS

Burras SPECIALS

ITALIAN FOOD
Mini

BEST Pizza

STARTERS

Burras SPECIALS

Main

The menu boards are illuminated and feature images of pizzas and other food items. The text is in a bold, sans-serif font. The boards are mounted on a wall above the service counter.





BASICS

by NPS

Banquet Chairs
9100



Stack Chairs
850-CL



Folding Chairs
900



Personal Table
PT3000



Banquet Chairs



Vinyl Colors

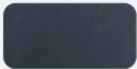

9104-B
Midnight Blue



9108-B
Pleasant Burgundy

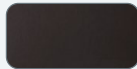

9110-B
Panther Black

Frame Color

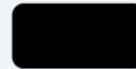

Black



Features



1" High Density
Grade-A Foam Seat



3/4" 19 Gauge
Square Tubing



Eight Plastic Stack
Bumpers for Secure
Stackability



Plywood Core
Seat and Back

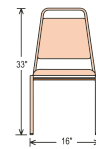

Stack Chairs



Colors



850-CL
Black



855-CL
Navy Blue

Features



Black
Powdercoated
Frame



18-Gauge,
1/2" Steel Tubing



Built-in Ganging
Glides Link Multiple
Chairs Together Easily



Polypropylene
Seat & Back



See Page 175 for

Dolly Specs



Compatible
with DOLLY

DY-CL85

Stack Up to
30
CHAIRS

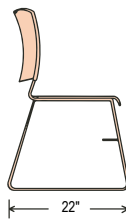
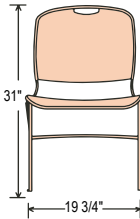

Folding Chairs

All-Steel 900 Series

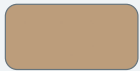
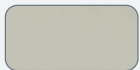
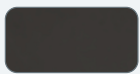

Colors

-  901
Beige
-  902
Grey
-  910
Black

Vinyl Upholstered 950 Series



Colors

-  950
Black Vinyl
Black Frame
-  951
Beige Vinyl
Beige Frame
-  952
Grey Vinyl
Grey Frame

Fabric Upholstered 970 Series



Colors

-  970
Star Trail Black Fabric
Black Frame
-  973
Star Trail Brown Fabric
Beige Frame
-  974
Star Trail Blue Fabric
Navy Blue Frame

Features



Non-Marring
Glides



19-Gauge Steel
Frame



Single Hinge



Two Tack Welded
Leg Braces

See Page 172 for
Dolly Specs
Compatible
with **DOLLY**
DY-35, DY-50

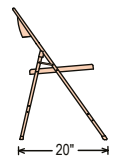
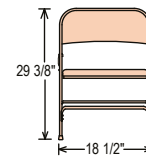

WEIGHT CAPACITY
250
lbs

2 DAY
LIGHTNING SHIP

one year
warranty
1



Features



1.67" Thick Tabletop

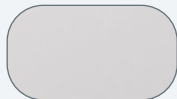

Speckled Grey Tabletop



20"x30" Tabletop



Powder Coated Textured Grey Frames and Legs

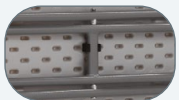

Plastic Clip to Hold Legs in Place



Glides Are Strong and Not Easily Removable



Adjustable Height Mechanism



Fully Welded Cross Brace

ADJUSTABLE TO SIX HEIGHTS

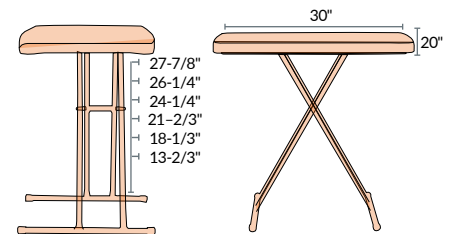

DESIGN OPTIONS Tabletop Guide



High Pressure Laminate

CORE MATERIAL	Industrial Grade Particleboard, MDF, or Plywood
FINISH	Matte Finish, Color Options Vary Per Product
EDGE	Vinyl T-Mold, 3MM PVC Edge Banding or Protect Edge
THICKNESS	Mobile Tables: 3/4" • Cafe Tables: 1-1/4" • Heavy-Duty Standard: 3/4" • Heavy-Duty Supreme: 1-1/4" • Science HPL: 1-1/8" • Togo: 1-1/4"



Chem-Res

CORE MATERIAL	Industrial Grade Particleboard with Chemical Resistant High Pressure Laminate (HPL) on Top Side, Resin Backer Sheet on Bottom Side
FINISH	Black, Matte Finish
EDGE	3MM PVC Edge Banding bonded with heated adhesive
THICKNESS	1"



Phenolic

CORE MATERIAL	Solid Phenolic Resin
FINISH	Black, Matte Finish
EDGE	1/8" Bevel Edge
THICKNESS	3/4"



Epoxy

CORE MATERIAL	Solid Epoxy Resin
FINISH	Black, Matte Finish
EDGE	1/8" Bevel Edge
THICKNESS	1"



Trespa

CORE MATERIAL	Cellulose
FINISH	Black, Matte Finish
EDGE	1/8" Bevel Edge
THICKNESS	3/4"



Whiteboard

CORE MATERIAL	Industrial Grade Particleboard with High-Pressure Laminate (HPL) Top
FINISH	Whiteboard Surface
EDGE	3MM PVC Edge Banding
THICKNESS	1.25"



Butcherblock

CORE MATERIAL	Solid Hard Maple Edge Grain Top
FINISH	Proprietary Urethane-Based Satin Finish or Natural Penetrating Oil Finish. <i>See Page 181 for Details</i>
EDGE	Long Edge Beveled • Square Ends
THICKNESS	1.75"

MAINTENANCE INSTRUCTIONS: Clean butcher block surfaces with soapy water or common kitchen counter top cleaners. Do not use abrasives or powder cleansers. Do not allow moisture to stand on the surface for prolonged periods of time.

Standard Edges *No minimum required*

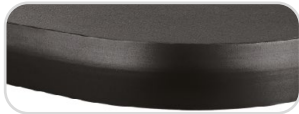

Vinyl T-Molding | Black (TM)



Protect Edge | Black (PE)



3MM PVC Edge Banding | Black (EB)

Premium Edges *May be subject to minimum quantity and upcharge*

VINYL T-MOLD



Navy (TN)



Green (TG)



Red (TR)



Brown (TO)



Beige (TB)



Silver (TS)



Medium Grey (TE)



Light Grey (TL)

PROTECT EDGE



Navy (PN)



Green (PG)



Red (PR)



Purple (PP)



Orange (PO)



Beige (PB)



Dark Grey (PD)



Medium Grey (PM)

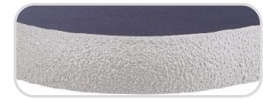

Light Grey (PL)

3MM PVC
EDGE BANDING



Navy (EN)



Green (EG)



Red (ER)



Purple (EP)



Beige (EE)



Dark Grey (ED)



Medium Grey (EM)



Light Grey (EL)

Stool Top Color Options



Grey (02)



Blue (04)



Green (06)



Burgundy (08)



Black (10)



Yellow (25)



Purple (28)



Red (40)



Pacific Blue (14)



Pea Pod (16)



Tangerine (17)

Custom Logo Options

Upcharge and extended lead times apply



Standard Laminates

No minimum required



Robin
RN



Port
PO



Regimental Red
RR



Hollyberry
RE



Candy Apple
CD



Dragon Fire
DF



Orange Grove
OG



Hunter Green
GR



Morrocan
MA



Ocean
OC



Persian Blue
BL



Lapis Blue
LB



Catalina
CI



Indigo
IN



Cassis
XS



Concord Grape
CG



Graphite Nebula
GN



Asian Night
AN



Rustic Slate
RS



Forged Steel
FS



Figured Mahogany
MY



Windsor Mahogany
WM



Lowell Ash
LA



Burnished Chestnut
CT



Buka Bark
KB



River Cherry
RC



Nepal Teak
NT



Wild Cherry
CH



Bannister Oak
OK



Castle Oak
CO



Limber Maple
LM



Kensington Maple
KS



Fusion Maple
FM



Manitoba Maple
MT



Almond Leather
AL



Boardwalk Oak
BD



Steel Mesh
SL



Slate Grey
SG



Mystic Night
MN



Pewter Brush
PB



Windswept Pewter
WP



Twilight Zephyr
TZ



Sheer Mesh
SM



Crisp Linen
CL



High Rise
HR



Frosty White
FW



White Sand
WS

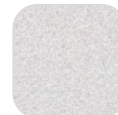

Titanium EV
EV



Carbon Ev
CE



Evening Tigris
ET



Bronze Legacy
BZ



Pearl Soapstone
PS



Grey Glace
GG



Grey Nebula
GY



Platinum
PL



Fashion Grey
GF



White Nebula
WN



White Tigris
TW



Grey
RG



Grey Pampas
PP

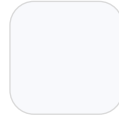

Designer White
DW



Blackbird
CK



Black
BK

Premium Laminates

Minimum Quantity, Upcharge and 10 week lead time apply

						
Maroochy Brush MB	Marigold YW	Island IS	Fresh Cut FE	Marmalade ML	Quince QN	Wheat Berry BY
						
Atlantis AT	Brittany Blue BB	Woolamai Brush WO	Navy Legacy NL	Kale Leaf KL	Blue Curacao CR	Biltmore Cherry BC
						
Coffee Bean CB	Montana Walnut WT	Windswept Bronze WZ	Pinnacle Walnut PN	Williamsburg Cherry WC	Xanadu XD	Skyline Walnut SW
						
Fonthill Pear FP	Harvest Maple HM	New Age Oak NW	Monticello Maple MP	Charcoal Velvet CV	Deepstar Agate DS	White Cypress CY
						
Natural Almond NA	Desert Zephyr DZ	Natural Tigris NG	Natural Nebula NN	White Driftwood WD	Grey Elm GE	Portico Teak PT
						
Earthen Warp EW	Pewter Mesh PW	Green Tigris GT	Dove Grey DG	Italian Silver Ash IA	Cosmic Strandz CS	Ink Vesta IV
						
Tailored Linen TA	North Sea NS	Pressed Linen LN	Cloud Nebula CN	Gold Alchemy GA	Whiteboard WB	

**IF YOU DON'T
SEE A LAMINATE,
JUST ASK!**

Choose any laminates from:

May be subject to minimum quantity and upcharge



Custom Banquet Chairs

MOQ, upcharge and extended lead time apply

Fabrics



Midnight Blue
54



Ebony Black
60



Natural Chocolatier
61



Natural Greystone
62



Diamond Navy
64



Natural Blue
74



Natural Taupe
78



Auburn
F201



Brown
F202



Charcoal
F203

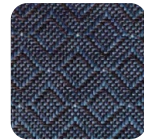

Cobalt
F204

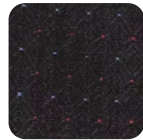

Black Patterned
F205

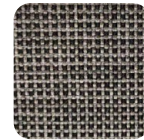

Fossil
F206



Golden Burgundy
F207



Grape
F208



Brown Dot
F209



Grey Dot
F210

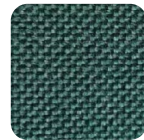

Hunter Green
F211



Indigo
F212



Mixed Tan
F214



Pink Grape
F215



Purple
F216



Red Rose
F217



Walnut
F218



Diamond Burgundy
F219



Graphite
F220

Vinyls



French Beige
01



Midnight Blue
04



Pleasant Burgundy
08



Panther Black
10



Black
V101



Dark Brown
V102



Cobalt Blue
V103



Tan
V104



Burgundy
V105



Medium Brown
V106



Textured Black
V107

Model # Description

93	9300 Series Silhouette Stack Chair
92	9200 Series Dome Stack Chair

Frames



Black Santex
BT



Silvervein
SV



Mocha
M

Model Number Configuration



Custom Phenolics and Butcherblock Finishing Options

Black Core Phenolic

MOQ, upcharge and extended lead time apply



PFG705



PFS729



PBW954



PMO829



PAL029



PFO9435



PLG0428



PGS3978



PSR938



PNB6697



PSO5328



PEA2435



PPU858



PMJ1578



PNB969

Color Thru Phenolic

MOQ, upcharge and extended lead time apply



PNB969CT



PMO829CT



PMJ1578CT

Butcherblock Finishing Options

STANDARD



Urethane-Based Satin Finish

Code: BB

CORE MATERIAL	Solid Hard Maple Edge Grain Top
FINISH	Proprietary Urethane-Based Satin Finish
EDGE	Long Edge Beveled • Square Ends
THICKNESS	1.75"
FOOD SAFE	Yes

MAINTENANCE Recommended to re-finish every 2-3 weeks depending on usage.



Refinishing can be done fairly quickly using a rag and Emmet's Good Stuff Gel Urethane

CUSTOM



Varnique Semi-Gloss Finish

Upcharge and Extended Lead Time apply

Code: BV

CORE MATERIAL	Solid Hard Maple Edge Grain Top
FINISH	Natural Penetrating Oil Finish
EDGE	Long Edge Beveled • Square Ends
THICKNESS	1.75"
FOOD SAFE	Yes

MAINTENANCE Recommended to re-finish every 3-4 weeks depending on usage.



Refinishing can be done fairly quickly using a rag and Boos® EZ-DO Finish



Limited Warranty: Since Natural Wood Products rely heavily on the care they receive, Butcherblock Tabletops have One Year Warranty. The rest of the parts of the product still carry a Ten Year Warranty.

NPS Product Specifications

FOLDING CHAIRS







50 SERIES / STEEL FOLDING CHAIR

DIMENSIONS: OVERALL: 29 3/8"H X 18 1/2"W X 20"D
FOLDED: 38"H X 18 3/4"W X 2"D
SEAT: 16 3/4"H X 15 3/4"W X 16"D / BACK: 8 3/4"H X 18 3/4"W

- Electromagnetically welded seat back
- Features 19-gauge 7/8" round tubular frame with 2 1/2" frame strengthener
- Powder-coated frame
- Two 19-gauge 5/8" U-shaped double riveted cross braces
- Single hinge on each side for added stability and durability
- Color coordinated V-tip plugs for added stability
- Color coordinated polypropylene glides
- Seat with a waterfall front for added comfort
- 500 lbs. static load weight capacity
- Available Colors:  Beige  Grey  Black





200 SERIES / STEEL PREMIUM FOLDING CHAIR

DIMENSIONS: OVERALL: 29 5/8"H X 18 3/8"W X 19 1/2"D
FOLDED: 38"H X 18 1/4"W X 2"D
SEAT: 17 1/4"H X 16"W X 16"D / BACK: 8 1/4"H X 18 1/4"W

- Electromagnetically welded seat back
- Two U-shaped double riveted cross braces
- Features 18-gauge 7/8" round tubular frame
- Powder-coated frame
- Double hinges on each side for added stability and durability
- Color coordinated V-tip plugs for added stability
- Color coordinated polypropylene glides
- Features our unique full size double contoured square back and waterfall seat
- 500 lbs. static load weight capacity
- Available Colors:  Beige  Grey  Brown  Char-Blue  Black  Red





300 SERIES / STEEL TRIPLE BRACE FOLDING CHAIR

DIMENSIONS: OVERALL: 29 1/2"H X 18 7/8"W X 20"D
FOLDED: 38"H X 18 1/4"W X 2"D
SEAT: 17 1/4"H X 16"W X 16"D / BACK: 8 1/4"H X 18 1/4"W

- Features 18-gauge 7/8" round tubular frame
- Three U-shaped double riveted cross braces
- Powder-coated frame
- Electromagnetically welded seat back
- Features our unique full size double contoured square back and waterfall seat
- Double hinges on each side for added stability and durability
- Color coordinated V-tip plugs for added stability
- Color coordinated polypropylene glides
- 500 lbs. static load weight capacity
- Available Colors:  Beige  Grey  Brown  Char-Blue  Black





600 SERIES / BLOW MOLDED RESIN PLASTIC FOLDING CHAIR

DIMENSIONS: OVERALL: 32"H X 18 3/4"W X 21 1/2"D
FOLDED: 42 1/2"H X 18 3/4"W X 3"D
SEAT: 18"H X 15 3/4"W X 16 5/8"D / BACK: 9 1/4"H X 18 3/4"W

- Features 19-gauge 1" O.D. steel frame with metal underbracing on seat for added durability
- Two cross braces for strength
- Powder-coated frame
- Single hinges on each side for added stability and durability
- Lightweight indoor/outdoor use
- Contoured seat and back for comfort
- 500 lbs. static load weight capacity
- Available Colors:  Light Grey seat/back and textured powder coated Grey frame
 Red or Blue seat/back and powder coated Black frame
 Charcoal Slate Plastic/Silvertone Frame
 Black Plastic/Black Frame



800 SERIES / PREMIUM LIGHTWEIGHT FOLDING CHAIRS

DIMENSIONS: OVERALL: 29 3/4"H X 18 3/4"W X 20 3/4"D
FOLDED: 38"H X 18 3/4"W X 2 1/2"D
SEAT: 18"H X 15 3/4"W X 16 1/4"D / BACK: 7 1/2"H X 18 1/2"W

- Features 18-gauge 7/8" round tubular frame
- Two U-shaped double riveted cross braces
- Powder-coated frame
- Double hinges on each side for added stability and durability
- Color coordinated V-tip plugs for added stability
- Color coordinated polypropylene glides
- Features a color-impregnated plastic seat and back
- Stacks up to 80" high (36 chairs) with specially designed stacking tabs
- Weight only 8.5lbs.
- 500 lbs. static load weight capacity
- Available Colors:  Grey/Grey  Blue/Grey  Burgundy/Black
 Black/Black  Bright White/White





1100 SERIES / POLYFOLD FAN-BACK FOLDING CHAIR

DIMENSIONS: OVERALL: 34 1/2"H X 18 1/2"W X 20 3/4"D
FOLDED: 44"H X 18 1/2"W X 20 3/4"D
SEAT: 17 3/4"H X 15 3/4"W X 16"D / BACK: 13 1/2"H X 18 3/4"W X 4"D

- Features 18-gauge 7/8" round tubular frame
- Three U-shaped double riveted cross braces
- Powder-coated frame
- Double hinges for added stability and durability
- Color coordinated V-tip plugs for added stability
- Color coordinated polypropylene glides
- Features our unique full size double contoured high back and waterfall seat
- Stacks up to 26 High
- 500 lbs. static load weight capacity
- Available Colors:  Blue Plastic/Grey Frame  Dark Blue Plastic/Grey Frame
 Black Plastic/Black Frame





1200 SERIES / PREMIUM STEEL VINYL FOLDING CHAIR

DIMENSIONS: OVERALL: 29 1/2"H X 18 3/4"W X 20 1/4"D
FOLDED: 38"H X 18 1/4"W X 2 1/2"D
SEAT: 17 3/4"H X 16"W X 16"D / BACK: 8 3/4"H X 18 3/4"W

- Features 18-gauge 7/8" round tubular frame
- Two U-shaped double riveted cross braces
- Powder-coated frame
- Double hinges for added stability and durability
- Color coordinated V-tip plugs for added stability
- Color coordinated polypropylene glides
- Features our unique full size double contoured back and waterfall seat
- Vinyl and Foam are Cal 117 rated
- .80MM Vinyl over 1 1/4", 0.9lb. density foam seat and 1.2lb. density back
- Fully upholstered seat and back attached with 6 rivets
- 500 lbs. static load weight capacity
- Available Colors:  French Beige/Beige  Warm Grey/Grey
 Honey Brown/Beige  Dark Midnight Blue/Blue
 Caviar Black/Black

1300 SERIES / PREMIUM STEEL VINYL FOLDING CHAIR

DIMENSIONS: OVERALL: 29 1/2"H X 18 3/4"W X 20 3/4"D
FOLDED: 38"H X 18 1/4"W X 2 1/2"D
SEAT: 17 3/4"H X 16"W X 16"D / BACK: 8 3/4"H X 18 3/4"W

- Features 18-gauge 7/8" round tubular frame
- Three U-shaped double riveted cross braces
- Powder-coated frame
- Double hinges for added stability and durability
- Color coordinated V-tip plugs for added stability
- Color coordinated polypropylene glides
- Features our unique full size double contoured back and waterfall seat
- Vinyl and Foam are Cal 117 rated
- .80MM Vinyl over 1 1/4", 0.9lb. density foam seat and 1.2lb. density back
- Fully upholstered seat and back attached with 6 rivets
- 500 lbs. static load weight capacity
- Available Colors:  French Beige/Beige  Warm Grey/Grey  Dark Midnight Blue/Char-Blue
 Caviar Black/Black  Honey Brown/Beige

NPS Product Specifications

1400 SERIES / AIRFLEX® FOLDING CHAIR

DIMENSIONS: OVERALL: 32" H X 21.5" W X 20.75" D
FOLDED: 40.25" H X 19.50" W X 2" D
SEAT: 8" H X 17" W X 18" / BACK: 7.5" H X 19.5" W / WEIGHT: 9.6 LBS.

- Features 18-gauge steel frame for lasting durability
- 7/8" square leg tubing for added strength
- Seat strengthened with 2 side 11 gauge steel supports
- Durable Industrial Grade 3.8MM Polypropylene
- Backrest secured with rivets
- Nesting/Stacking assist glide
- Designed for easy stacking
- Oversized 18" seat
- 1000 Lb. weight capacity
- Sweat-free ventilation
- 1000 lbs. weight capacity
- Available colors: ■ Black ■ White

2200 SERIES / PREMIUM STEEL FABRIC FOLDING CHAIR

DIMENSIONS: OVERALL: 29 1/2"H X 18 3/4"W X 20 1/4"D
FOLDED: 38"H X 18 1/4"W X 2 1/2"D
SEAT: 17 3/4"H X 16"W X 16"D / BACK: 8 3/4"H X 18 3/4"W

- Features 18-gauge 7/8" round tubular frame
- Two U-shaped double riveted cross braces
- Powder-coated frame
- Double hinges on each side for added stability and durability
- Color coordinated V-tip plugs for added stability
- Color coordinated polypropylene glides
- Features our unique full size double contoured back and waterfall seat
- Fabric is rated to 30,000 double rubs
- Fabric and Foam are Cal 117 rated
- Institutional grade fabric over 1 1/4", 0.9lb. density foam seat and 1.2lb. density back
- 500 lbs. static load weight capacity
- Available Colors: ■ Café Beige/Beige ■ Greystone/Grey ■ Imperial Blue/Blue ■ Imperial Blue/Grey ■ Russet Walnut/Brown ■ Majestic Cabernet/Grey ■ Midnight Black/Black

2300 SERIES / PREMIUM STEEL FABRIC FOLDING CHAIR

DIMENSIONS: OVERALL: 29 1/2"H X 18 3/4"W X 20 3/4"D
FOLDED: 38"H X 18 1/4"W X 2 1/2"D
SEAT: 17 3/4"H X 16"W X 16"D / BACK: 8 3/4"H X 18 3/4"W

- Features 18-gauge 7/8" round tubular frame
- Three U-shaped double riveted cross braces
- Powder-coated frame
- Double hinges on each side for added stability and durability
- Color coordinated V-tip plugs for added stability
- Color coordinated polypropylene glides
- Features our unique full size double contoured back and waterfall seat
- Fabric and Foam are Cal 117 rated
- Scotchguarded fabric is rated to 30,000 double rubs
- Institutional grade fabric over 1 1/4", 0.9lb. density foam seat and 1.2lb. density back
- 500 lbs. static load weight capacity
- Available Colors: ■ Café Beige/Beige ■ Greystone/Grey ■ Imperial Blue/Blue ■ Majestic Cabernet/Grey ■ Midnight Black/Black

3200 SERIES / PREMIUM STEEL FABRIC OR VINYL FOLDING CHAIR

DIMENSIONS: OVERALL: 32"H X 18 3/4"W X 20 3/4"D
FOLDED: 39 3/4"H X 18 3/4"W X 3 3/4"D
SEAT: 18 1/2"H X 15 3/4"W X 15 1/2"D / BACK: 8 3/4"H X 18 3/4"W

- 2" Upholstered box seat on a masonite board with 8 rivets
- Features 18-gauge 7/8" round tubular frame
- Two U-shaped double riveted cross braces
- Powder-coated frame
- Double hinges on each side for added stability and durability
- Color coordinated V-tip plugs for added stability
- Color coordinated polypropylene glides
- Fabric and Foam are Cal 117 rated

- Fabric is rated to 30,000 double rubs
- Institutional grade fabric over 1 1/4", 0.9lb. density foam seat and 1.2lb. density back
- Padded backs are fully covered in fabric or vinyl on both sides
- 300 lbs. weight capacity
- Available Colors: ■ Charcoal Grey Fabric/Black Frame ■ Regal Blue Fabric/Grey Frame ■ New Burgundy Fabric/Grey Frame ■ Antique Gold Fabric/Brown Frame ■ Black Vinyl/Black Frame ■ Beige Vinyl/Beige Frame

5200 SERIES / PREMIUM STEEL FOLDING CHAIR WITH TABLET ARM (LEFT OR RIGHT)

DIMENSIONS: OVERALL: 29 1/2"H X 20 1/2"W X 28 3/4"D; TABLET ARM 5/8" H X 22L" X 11" W
FOLDED: 38"H X 18 1/4"W X 4"D
SEAT: 17 1/4"H X 16"W X 16" D / BACK: 8 1/4"H X 18 1/4"W

- Features 18-gauge 7/8" round tubular frame
- Two U-shaped double riveted cross braces
- Powder-coated frame
- Double hinges on each side for added stability and durability
- Color coordinated V-tip plugs for added stability
- Color coordinated polypropylene glides
- Features our unique full size double contoured square back and waterfall seat
- 500 lbs. static load weight capacity
- Available Colors: ■ Grey Tablet Arm/Black Frame

STACK CHAIRS

8100 SERIES / POLY SHELL CHAIR

DIMENSIONS: OVERALL: 31"H X 19 1/4"W X 19 1/4"D
SEAT: 18"H X 17"W X 16 3/4"D
OPTIONAL TABLET ARM: 5/8"H X 11"W X 23 1/2"D - WRITING SPACE: 12 1/2"L X 11"W

- Features a chrome plated frame with 17-gauge 7/8" square tubing
- 3 underseat cross braces for added stability and durability
- Features a one piece, injection molded, color-impregnated, high-density polypropylene seat/back
- Shell and frame shields to protect against snags and pinching
- Anti-static shell
- Can be stacked 12 high with 6 stack bumpers on each chair to protect finish
- 300 lbs. weight capacity
- Available Colors: ■ Black ■ Blue

8500 SERIES / HI-TECH ULTRA COMPACT STACKER

DIMENSIONS: OVERALL: 31"H X 17 1/2"W X 22 1/2"D
SEAT: 17"H X 17 1/2"W X 17 1/4"D

- Optional removable bookrack & tablet arm; Tablet arm measures 11 1/2" x 20" laminated in Black, Writing space 11"L x 11 1/2"W
- Features an 11 mm solid steel rod with chrome plated frame
- Injection molded textured polypropylene plastic seat and back
- Specialized polyethylene glide with enhanced notching system for secure fit
- Reinforced underseat ribbing and EZ-Grip handle for added durability when lifting and stacking
- Optional ganging clamps available
- Can stack up to 40 high on DY85 dolly
- 300 lbs. weight capacity
- Available Colors: ■ Gunmetal ■ Navy ■ Wine ■ Black

8600 SERIES / SIGNATURE LIGHTWEIGHT FABRIC PADDED STACK CHAIR

DIMENSIONS: OVERALL: 33"H X 19"W X 21"D
SEAT: 19"H X 16"W X 16"D

- Features a 5/8" 17-gauge tubular frame with 5/8" frame strengthener
- Contoured Seat and Back for Enhanced Comfort
- Fabric and Foam are Cal-117 Rated
- Fabric is rated to 150,000 double rubs
- Non-Marring floor glides
- Can stack up to 20 high with our DY-86 Dolly (19"W x 36"D x 57"H)
- 300 lbs. weight capacity
- Available Colors: ■ Black ■ Classic Grey

NPS Product Specifications

8700 SERIES / THE CAFETORIUM VINYL PADDED STACK CHAIR

- 16 gauge ½" round tubing fitted with 2" long & ¾" thick Nylon Ganger/glides
- TPU floor protector bottoms
- Back made of .21" (5.5mm) thick polypropylene
- Back assembled to frame with two tamper-free screws
- Seat upholstered with ISO-9002 certified 0.8m thick vinyl
- 5/8" foam thickness; 1.3 foam density
- Upholstered seat on multi-ribbed plastic seat base
- 12-gauge steel cross braces
- Can stack up to 35 high with our DY-87 Dolly (20 1/4"H x 35"D x 75"H)
- Cal 117 rated
- 300 lbs. weight capacity
- Available Colors: ■ 8704-10-04 ■ 8710-11-10 ■ 8742-12-02

8800 SERIES / THE CAFETORIUM POLY STACK CHAIR

- 18 gauge 1/2" round tubing fitted with 2" long & ¾" thick Nylon Ganger/glides
- TPU floor protector bottoms
- Seat and back made of .21" (5.5mm) thick polypropylene
- Back assembled to frame with two tamper-free screws
- 12-gauge steel cross braces
- Can stack up to 35 high with our DY-87 Dolly (20 1/4"H x 35"D x 75"H)
- Cal 117 rated
- 300 lbs. weight capacity
- Available Colors: ■ 8804-11-04 ■ 8810-11-10 ■ 8818-11-18 ■ 8820-11-20

BANQUET STACK CHAIRS

9100 SERIES / BASICS BY NPS

DIMENSIONS: OVERALL: 32 1/2"H X 17 3/4"W X 21 1/2"D
SEAT: 17 1/2"H X 16"W X 16 1/8"D

- Features a Sturdy 3/4" square frame 19-gauge steel tubing with non-marring plastic glides
- Steel Standard: ASTM A513
- Foam Standard: 1.8lb. density, 46 ILD
- Seat is cushioned with 1" of high-density Grade A foam
- Vinyl & Foam are Cal-117 rated
- Available with thick .80MM vinyl
- Tapered back has built-in handhold
- Eight plastic stack bumpers protect the powder-coated frame finish
- Stack 8-10 high with DY81 or DY9000 dollies
- Nylon glides
- 300 lbs. weight capacity
- Available Vinyl Upholstery Colors: ■ Pleasant Burgundy ■ Panther Black ■ Midnight Blue
- Available Frame Colors: ■ Black

9200 SERIES / DOME-BACK STACKER

DIMENSIONS: OVERALL: 34 3/4"H X 17 3/4"W X 20 1/2"D
SEAT: 18 7/8"H X 15 1/2"W X 16"D

- Features a 7/8" Square-tube 18-gauge steel frame with 5/8" under seat and H-braces
- Steel Standard: ASTM A513
- Foam Standard: 1.8lb. density, 46 ILD
- 2" thick Grade A foam; cushion is double stitched with a spacious 34"H x 16"W x 16"D waterfall seat
- Available in choice of institutional grade fabrics rated to 67,000-130,000 double rubs or thick .80MM vinyl
- Fabric and Foam are Cal-117 Rated
- The back has a convenient handhold for easier moving and stacking
- Stacking bars and 12 plastic stack bumpers ensure stacking securely without damaging the attractive powder-coated frame finish.
- Stack 8-10 high with DY81 or DY9000 dollies
- Nylon glides
- 500 lbs. static load weight capacity
- Available Fabric colors: ■ Midnight Blue ■ Ebony Black ■ Burgundy
- Available Upholstery color: ■ Diamond Navy

- Available Vinyl colors: ■ French Beige ■ Midnight Blue ■ Panther Black
- Available Chair frame colors: ■ Mocha (available with French Beige Vinyl only) ■ Silvervein ■ Black Santex

9300 SERIES / SILHOUETTE STACKER

DIMENSIONS: OVERALL: 37 1/4"H X 17 1/4"W X 21 3/4"D
SEAT: 18 7/8"H X 15 1/2"W X 16"D

- Features a 7/8" Square-tube 18-gauge steel frame with 5/8" under seat and H-braces
- Steel Standard: ASTM A513
- Foam Standard: 1.8lb. density, 46 ILD
- Waterfall seat, padded with 2" of 1.8lb. high-density Grade A foam with double-stitched box seat
- Features a concealed double back with 4 covered metal tabs for a more refined look.
- Available in choice of institutional grade fabrics rated to 67,000-130,000 double rubs or thick .80MM vinyl
- Fabric and Foam are Cal-117 rated
- Nylon glides won't scuff floors
- Built-in stack bar and 12 plastic stack bumpers help prevent wear and tear
- Stack 8-10 high with DY81 or DY9000 dollies
- 500 lbs. static load weight capacity
- Available Fabric/Frame color combos: ■ Midnight Blue Fabric/Silvervein Frame ■ Ebony Black Fabric/Black Santex Frame ■ Natural Chocolatier Fabric/Black Santex Frame ■ Natural Greystone Fabric/Black Santex Frame ■ Diamond Navy Fabric/Silvervein Frame ■ Diamond Burgundy Fabric/Silvervein Frame ■ Natural Blue Fabric/Black Santex Frame ■ Natural Taupe Fabric/Black Santex Frame ■ Midnight Blue Vinyl/Silvervein Frame ■ Panther Black Vinyl/Black Santex Frame ■ Panther Black Vinyl/Black Silvervein Frame

MOBILE CHAIR

COGO / MOBILE TABLET CHAIR

DIMENSIONS: TOTAL HEIGHT: 34" TOTAL WIDTH: 24.75" (W/TABLET IN SIDE POSITION)
SEAT: 17.5"W X 18.75"H X 16"D / TABLET: 19.5"W X 13.75"D
UNDER SEAT STORAGE: 16.75"W X 16.75"D
/ WEIGHT: 25LBS.

- Ergonomically designed for all-day seating support
- Fiberglass-reinforced polypropylene
- Features a tablet holder
- 440 lbs. weight capacity
- Heavy duty 16-gauge steel
- Strong twin wheeled 2" casters
- Optional glides available
- Steel washer plates are welded onto the frame and a steel tab is welded onto the arm, providing firm support and preventing the arm from sagging.
- Tablet can be installed on right or left side and boasts a 150 lbs. weight capacity
- Available seat colors: ■ Red ■ Black ■ Blue
- Available base and tablet colors: ■ Grey

CADDIES / DOLLIES

42-8 / CHAIR CADDY

DIMENSIONS: OVERALL: 67" W x 33 1/4"D x 70"H - weight 88 lbs.

- 7-gauge main frame features channeled steel with tube in tube design at peak stress point of frame for added strength and stability
- 14-gauge cross braces
- 16-gauge hanging rods
- Heavy-duty caster features 325lb. weight capacity and measures 4" x 1 1/4"
- Swivel wheels for easy gliding
- Chair capacity to hold 42 chairs and 8-10 tables either steel or plastic
- Dark Brown Powder Coated Steel
- Not for use with BT3060

MODEL 42-8-60 / CHAIR CADDY

DIMENSIONS: OVERALL: 67" W X 33 1/4"D X 70"H - WEIGHS 102LBS.

- 7-gauge main frame features channeled steel with tube in tube design at peak stress point of frame for added strength and stability
- 14-gauge cross braces

NPS Product Specifications

- 16-gauge hanging rods
- Heavy-duty caster features 325lb. weight capacity and measures 4" x 1 1/4"
- Swivel wheels for easy gliding
- Chair capacity to hold 42 chairs and 8-10 tables
- Includes two coat rods
- Dark Brown Powder Coated Steel

84 / CHAIR CADDY

DIMENSIONS: OVERALL: 67"W X 33 1/4"D X 70"H - WEIGHT 100 LBS.

- 7-gauge main frame features channeled steel with tube in tube design at peak stress point of frame for added strength and stability
- 14-gauge cross braces
- 16-gauge hanging rods
- Heavy duty caster features 325lb. weight capacity and measures 4" x 1 1/4"
- Swivel wheels for easy gliding
- Chair capacity 84 standard folding chairs
- Dark Brown Powder Coated Steel
- Optional EXT-8 Extension Bar Available

84-60 / CHAIR CADDY

DIMENSIONS: OVERALL: 67"W X 33 1/4"D X 70"H - WEIGHT 105 LBS.

- 7-gauge main frame features channeled steel with tube in tube design at peak stress point of frame for added strength and stability
- 14-gauge cross braces
- 16-gauge hanging rods
- Heavy-duty caster features 325lb. weight capacity and measures 4" x 1 1/4"
- Swivel wheels for easy gliding
- Capacity to hold 60-70 coats when two coat rods are in place. Coat rods can be removed to store up to 84 Folding Chairs
- Dark Brown Powder Coated Steel

MODEL 84/42-60-8 / CHAIR-TABLE-COAT CADDY

DIMENSIONS: OVERALL: 67"W X 33 1/4"D X 70"H - WEIGHTS 122LBS.

- 7-gauge main frame features channeled steel with tube in tube design at peak stress point of frame for added strength and stability
- 14-gauge cross braces
- 16-gauge hanging rods
- Heavy-duty caster features 325lb. weight capacity and measures 4" x 1 1/4"
- Swivel wheels for easy gliding
- Interchangeable middle bar; one for hanging-chairs or straight bar for folding tables
- Two coat rods
- Dark Brown Powder Coated Steel

DY-35 & DY-50 / FOLDING CHAIR TRUCK

DIMENSIONS: DY-35 OVERALL: 38 1/2"H X 19 1/4"W X 81"D
DY-50 OVERALL: 38 1/2"H X 19 1/4"W X 106"D
INSIDE WIDTH: 19"W WITH A 2" LIP TO ACCOMMODATE CHAIRS 15 1/4"W - 19"W

- Optional Understage Conversion Kit to store chairs in a horizontal fashion underneath stages 25.5" Height capacity with chairs loaded
- 7-gauge steel bed
- Heavy-duty caster features 275lb. weight capacity; 2 swivel and 2 stationary
- DY-50 has extra swivel caster in the middle for support
- 3 tubular handles-one at each end and one in the middle
- Dark Brown Powder Coated Steel

DY81 / CHAIR TRUCK

DIMENSIONS: OVERALL: 3.5"H X 22 3/4"W X 23 1/2"D WITH A 5.25"W BED

- 16-gauge, 1.6MM steel
- Holds up to 10 8100 or 9000 Series Stack Chairs
- Black Powder Coated Steel
- Shipping Class 85
- Hard Rubber casters 4" x 1 1/4"
- 265 lbs. weight capacity

DY82 / DOLLY FOR 8200 SERIES CHAIRS

DIMENSIONS: OVERALL: 38"H X 22 3/4"W X 35"L

- 16-gauge, 3/4" round handles
- 17-gauge, 7/8" square frame
- Stacks up to 18 series 8200 chairs
- 4 casters; Two swivel, two non-swivel. 4" x 1 1/4"
- Ship weight: 24 lbs
- Chrome-plated steel
- 330 lbs. weight capacity

DY85 / CHAIR DOLLY

DIMENSIONS: OVERALL: 26"H X 20 1/2"W X 21"D

- Constructed of 11-gauge steel
- Chairs load at an angle to maximize stack ability
- Stacks up to 40 of the 8500 Series
- Black Powder Coated Steel
- Hard rubber casters: 4 x 1 1/3"
- Fully loaded: 20.5"W x 35"D x 77"H
- 650 lbs. weight capacity

DY86 / DOLLY FOR 8600 SERIES CHAIRS

DIMENSIONS: OVERALL: 26"H X 21"W X 21"D

- 11-gauge, 1" x 2" angled steel
- Stacks up to 20 series 8600 chairs (19"H x 36"D x 57"H)
- Ship weight: 37 lbs
- Nylon casters 2 3/4" x 1 1/5"
- 330 lbs. weight capacity

DY87 / DOLLY FOR 8700 SERIES CHAIRS

DIMENSIONS: OVERALL: 26"H X 18 1/2"W X 28"L

- 18-gauge steel frame
- Stacks up to 35 series 8700 chairs (20 1/4"W X 35"D X 75 1/2"H)
- 4 PVC swivel locking casters; 154lb. per caster weight capacity; 616 lb. total weight capacity
- Ship weight: 15 lbs
- Grey powder coated finish

DY87B / DOLLY FOR 8700B SERIES CHAIRS

DIMENSIONS: OVERALL: 26"H x 18 1/2"W x 28"L

- 18-gauge 7/8" tubing
- Stacks up to 24 series 8700B/8800B stools (84"H)
- Max stack for 80" doorway - 22 units
- Product weight: 18 lbs
- Carton weight: 23 lbs
- Carton dimensions: 19"W x 35"D x 51"H
- 4 PVC Swivel Locking Casters: 154 lbs. per caster weight capacity and 616 lbs. total weight capacity

DY700/800 / CHAIR DOLLY

DIMENSIONS: OVERALL: 35"H X 40"W X 19"D

- Constructed of 11-gauge steel
- 7/8" round tubular handle and 4" polyolefin casters; 2 swivel
- Stacks up to 36 of the 800 Series
- Optional strap to tie down chairs during transport and storage
- Black Powder Coated Steel
- Hard rubber casters: 4 x 1 1/4"
- 82" H when fully loaded with 36 chairs

DY1100 / CHAIR DOLLY

DIMENSIONS: OVERALL: 39"H X 19"W X 46 1/2"D

- 11-gauge powder-coated steel frame
- 2 swivel and 2 fixed 4" casters
- Storage and transport for 1100 Series Folding Chair
- Holds up to 26 chairs
- Black Powder Coated Steel

NPS Product Specifications

- Nylon casters: 4 x 1½"
- Loaded height: 80"

DY1400 / DOLLY FOR AIRFLEX SERIES CHAIRS

DIMENSIONS: OVERALL: 38 1/2"H X 19 1/4"W X 109 1/2"D

- Stacks 54 AirFlex chairs.
- Heavy-duty caster features 275lb. weight capacity; 2 swivel and 2 stationary
- Extra swivel caster in the middle for support
- 3 tubular handles-one at each end and one in the middle
- Dark Brown Powder Coated Steel

DY-9000 / BANQUET STACK CHAIR DOLLY

DIMENSIONS: OVERALL: 52"H X 18"W X 34"D

- 1" Round Tubular 16-gauge steel
- 8"D x 2"W Polyolefin wheels
- Stacks up to 12 Series 9000 and 8100 Series chairs
- Ship weight: 26 lbs
- Dark Brown Powder Coated Steel

DY-60R • DYMU / TABLE TRUCK

DIMENSIONS: OVERALL: 31½"H X 27¼"W X 47½"L FRONT HANDLE: 27¼"W X 15"D

- Transportation and vertical storage of 48" & 60" round, plastic or laminate tables
- Easy handling with 4 casters: 2 swivel and 2 stationary
- 2 tubular handles, 1 front handle
- Constructed of brown powder-coated steel
- Distance between wood slats: 27¼"
- Distance from frame to top of handle: 25½"
- Fully loaded height: 65"H
- Casters are 4" x 1½"; made of Hard Rubber with weight capacity of 165 lbs. each / 660 lbs. total

DY-71R / TABLE TRUCK

DIMENSIONS: TOTAL FOOTPRINT: 40½"H X 28"W X 61½"D FRONT HANDLE: 27¼"W X 15"D

- Transportation and vertical storage of 71" round, plastic or laminate tables
- Easy handling with 4 casters: 2 swivel and 2 stationary
- 2 tubular handles, 1 front handle
- Constructed of brown powder-coated steel
- Distance between wood slats: 27¼"
- Fully loaded height: 76"
- Casters are 4" x 1½"; made of Hard Rubber with a weight capacity of 165 lbs. each / 660 lbs. total

DY-3072 & DY-3096 / FOLDING TABLE DOLLY

DIMENSIONS: DY3072 OVERALL: 43"H X 31"W X 74"L DY3096 OVERALL: 43"H X 31"W X 90.25"L

- 1" O.D. steel handle provides stability and ease of handling
- Holds 4', 5', 6', or 8' tables
- Laid flat, stacks up to 12 tables high
- Rolls on 4 casters: 2 swivel and 2 stationary
- Dark Brown Powder Coated Steel
- Casters: 4 x 1½" with Weight Capacity of 165 lbs. each / 660 lbs. total (DY3072 - Hard Rubber, DY3096 - Hard Rubber)

TAD DOLLY / FOLDING TABLE DOLLY

DIMENSIONS: 44.5"H X 38"W X 30"L

- 1" square 14-gauge tubular frame
- 7/8" O.D. Steel Handle (18-Gauge) provides stability and ease of handling
- May be used for 4', 5', 6', or 8' Tables
- Rolls On 4 swivel Casters: 2 locking and two non-locking
- Casters Are 5" X 1 ½"; Hard rubber
- Textured black Powder-Coated Steel
- Plastic coated table support frames
- Total Weight Capacity: 1,000 Lbs.

Stools

6200 SERIES / HEAVY DUTY STEEL STOOLS

- 18"H, 24"H or 30"H sizes fixed and adjustable with an optional backrest
- 7/8" O.D. 18-gauge steel tubing
- Seat is a full 14" diameter with 11 1/2" diameter masonite board is recessed into the pan with 8 rivets and will not chip or crack
- Foot rings, 3/4" O.D. are welded to each leg by 4 contact points at each leg for added rigidity
- Optional backrest; 6"H x 12"W, adjusts up/down and forward/back
- Optional height adjustable legs; adjust in 1" increments up to eight additional inches
- All sizes available in black and grey colors

6300 SERIES / HEAVY DUTY SQUARE SEAT STEEL STOOLS

- 18"H, 24"H or 30"H sizes fixed and adjustable with an optional backrest
- 7/8" O.D. 18-gauge steel tubing
- Features a 14.5" Wx15"D contoured hardboard seat with 16 rivets
- Foot rings, 5/8" O.D. are welded to each leg by 4 contact points at each leg for added rigidity
- Optional backrest; 6"H x 12"W, adjusts up/down and forward/back
- Optional height adjustable legs; adjust in 1" increments up to eight additional inches

6400 SERIES / HEAVY DUTY STEEL STOOLS WITH VINYL PADDING

- 18"H, 24"H or 30"H sizes fixed and adjustable with an optional backrest
- 7/8" O.D. 18-gauge steel tubing with fixed or adjustable legs
- Seat is 14" diameter with an 11 1/2" diameter 1/2" vinyl padding riveted through the steel seat pan
- Foot rings, 3/4" O.D. are welded to each leg by 4 contact points at each leg for added rigidity
- Optional vinyl padded backrest; 6"H and 12"W and adjusts up/down and forward/back
- Optional height adjustable legs; adjust in 1" increments up to eight additional inches
- MDF seat board upgraded from 3mm to 4.75mm, with rivet heads fully embedded
- All sizes available in black and grey colors

6524H & 6524HB / ADJUSTABLE PREMIUM SWIVEL STOOL W/ BACKREST-GRAY

- Height adjustable from 24 - 32"
- 3/4" O.D. 16-gauge steel tubing
- Swivel seat 360 degrees
- Foot rings, 5/8" O.D. are welded to each leg by 4 contact points at each leg for added rigidity
- MDF seat board upgraded from 3mm to 4.75mm, with rivet heads fully embedded

6600 SERIES ELEPHANT Z-STOOL / HEAVY DUTY CHROME PLATED STOOLS WITH BLOW MOLDED SEAT

- 18"H, 22"H or 24"H sizes fixed with an optional backrest
- 14-gauge chrome-plated eye-shaped tubular steel frame
- Ergonomic blow molded contoured seat providing maximum air comfort
- U-shaped sled base legs with specially designed glides to be used on multiple floor types (including VCT tiles)
- Glides are permanently attached with embedded Thermoplastic Polyurethane (TPU) and provide quiet and smooth gliding on all floor types
- Nests on tabletops for easy cleanup and storage
- Optional blow molded contoured backrest
- Foot rests made of 17-gauge chrome eye-shaped tubular steel (available on 22"H and 24"H models)
- Available Colors: ■ Black

6722HB/6716HB KANGAROO STOOL / POLYURETHANE ADJUSTABLE STOOL

- Also available with arms as model 6722HB-A and 6716HB-A
- Heavy duty 1-1/4 inch thick Polyurethane seat with waterfall edge
- Polyurethane material is resistant to chemicals & punctures, & cleans easily
- 6722 Features 10" of pneumatic height adjustment from 22" - 32"
- 6716 Features 5" of pneumatic height adjustment from 16" - 21"
- Swivels 360 degrees for unlimited functionality
- Integrated under seat spring system allows for control of backrest tilt degree with a turn of a knob
- Footrest adjusts 12 inches up or down for comfort
- Built on five 2 inch industrial grade caster wheels for portability or install

NPS Product Specifications

- included mushroom glides for use in a stable environment
- Promotes natural sitting posture with lumbar support
- Convenient backrest handhold for maneuverability
- Material: Seat & Back: Polyurethane. Legs: Plastic. Footrest: Chrome.
- Seat height: 22 – 32 inches. Overall height: 38-48 inches
- Seat height: 22 – 32 inches. Overall height: 38-48 inches
- ANSI BIFMA tested.
- Green & LEED certification: MAS.
- Weight: 16lbs
- Ship via: UPS.
- Carton dimensions 24W" x 24L" x 12H" · Carton weight: 26 lbs.
- Available Colors: ■ Black

6800 DESIGNER STOOL

DIMENSIONS: OVERALL: 14½"W X 14½"D X 18"-25"H

- 1" diameter 18 gauge steel powdercoated tubing
- 113-3/4" diameter 18 gauge steel powdercoated seatpan with a variety of colored polypropylene surface
- 13-3/4" diameter 1" thick solid hardwood seat with a clear lacquer paint finishing
- Seat adjustable from 18" – 25" using the swivel mechanism
- 360° turning capability
- Metal center sleeve to conceal adjustable height pole
- Built in 4" height footrest with a 15" diameter
- Non-marring glides
- Seat is attached using a unique pressure connection mechanism
- The wooden seat is 1" thick hardwood with a clear lacquered paint finishing with either a Metallic Grey or a Black base.
- The stool frame is available in Metallic Grey and Black
- 20" Cross Leg Distance
- Product weight- 12.6 lbs.
- Carton weight- 16.5 lbs.
- Carton Dimensions- 15" x 17" x 21"
- Available colors Frames: ■ Metallic Grey ■ Black
- Seatpan: ■ Metallic Grey ■ Wood
- Seat Surface: ■ Blueberry ■ Persian Blue ■ Black ■ Burgundy
- Soft Seating: 3" H top in ■ Black ■ Charcoal ■ Cobalt Blue

8700B & 8800B CAFETORIUM BARSTOOL

DIMENSIONS: OVERALL: 44 5/8"H X 21 1/3"W X 21 5/8"D

- 18-Gauge 7/8" Tubing
- Solid 1" Plastic Stacking Glides
- Back Design Provides Ergonomic Support
- Cafetorium Chair in Bar/Café Height
- 300 lb Weight Capacity
- Available Colors Seat: ■ Black
- Available Colors Back: ■ Black
- Available Colors Frame: ■ Chrome

Tables

BT2448 / HEAVY DUTY FOLDING TABLE

- Speckled Grey Top/ Grey Hammertone Frame
- Available in 48" L rectangular size
- 1.75 in. Tabletop Thickness
- Plastic tabletop is heat-resistant up to 212° F
- Non-bowing eggshell structure
- Powder-coated 17-gauge steel frame
- Lightly Textured Surface Resist Scratching Yet Smooth Enough To Write On
- Extra Stable Gravity Lock
- 400 lbs. Weight Capacity when evenly distributed

BT3060 / BT3072 / BT3096 / LIGHTWEIGHT BLOW MOLDED FOLDING TABLES

- Available in 3 rectangular sizes – 60", 72", 96"
- 1 3/4" thick top for the BT3060 & BT3072
- 2" thick top for the BT3096
- Lightly spotted grey top w/ grey textured powder coated wishbone shaped legs.
- 17-gauge strength frame; 18-gauge legs
- 1,000lb. weight capacity on BT3060, BT3072, equally distributed weight

- 800lb. weight capacity on BT3096, equally distributed weight
- Stack up to 12 high on DY3072 and DY3096
- Can withstand heat up to 212 degrees Fahrenheit
- Gravity slide lock or snap lock, for extra stability
- Lightly textured surface to resist scratching yet smooth enough to write on

BT3072-20 / LIGHTWEIGHT BLOW MOLDED FOLDING TABLES

- 1 3/4" thick top
- Charcoal slate top w/ silver-tone frame.
- 17-gauge strength frame; 18-gauge legs
- 1,000lb. weight capacity, equally distributed weight
- Stack up to 12 high on DY3072 and DY3096
- Can withstand heat up to 212 degrees Fahrenheit
- Gravity slide lock or snap lock, for extra stability
- Lightly textured surface to resist scratching yet smooth enough to write on

BT3636 / SQUARE BLOW-MOLDED PLASTIC FOLDING TABLE

- Lightly textured surface to resist scratching yet smooth enough to write on
- Square shape
- 1 ¾" thick top
- Lightly spotted grey top w/ grey textured powder coated straight shaped legs on a square tabletop
- Tested and passed 500 lbs. distributed weight.
- Can withstand heat up to 212 degrees Fahrenheit
- Gravity slide lock or snap lock, for extra stability
- 19-Gauge Strength Frame And 19-Gauge Legs
- Attractive Arched tube leg connectors for added strength
- 10 Year Warranty
- Weighs 23 lbs.

BT48R/BT60R/BT71R / LIGHTWEIGHT BLOW MOLDED ROUND FOLDING TABLES

- Available in 3 round sizes - 48", 60", 71"
- 2" thick top
- Lightly spotted grey top w/ grey textured powder coated straight legs
- BT60R: 17-gauge strength frame; 18-gauge legs
- BT48R & BT71R: 19-gauge strength frame and legs
- 1,000lb. weight capacity on BT60R
- 700lb. weight capacity on BT48R & BT71R
- Holds up to 10 tables in DY60R and DY71R
- Can withstand heat up to 212 degrees Fahrenheit
- Gravity slide lock or snap lock, for extra stability
- Lightly textured surface to resist scratching yet smooth enough to write on

BTA-3072 / ALL AMERICAN COLORS BLOW MOLDED FOLDING TABLES

- Available in 72"L rectangular size
- 1 3/4" thick top
- BTA-3072 comes in primary colors Red or Blue & is height adjustable from 22"-28.5"H
- 17-gauge strength frame
- 1,000lb. weight capacity
- Stack up to 12 high on DY3072 and DY3096
- Can withstand heat up to 212 degrees Fahrenheit
- Gravity slide lock or snap lock, for extra stability
- Lightly textured surface to resist scratching yet smooth enough to write on
- Available colors: ■ Red ■ Blue

BT1860/BT1872/BT1896 / LIGHTWEIGHT FOLDING SEMINAR TABLES

- Available in 3 sizes; 60"L, 72"L & 96"L by 18"W
- 2-inch thick top
- Lightweight for easy set-up and transport
- 700lb. weight capacity
- Lightly spotted gray top w/ gray textured powder coated legs
- BT1860 & BT1872: 18-gauge strength frame
- BT1896: 17-gauge strength frame
- 16-gauge cantilevered comfort legs set 11" from back of table; no more banged up knees!
- Stack up to 12 high on DY3072 and DY3096
- Can withstand heat up to 212 degrees Fahrenheit
- Lightly textured surface to resist scratching yet smooth enough to write on

NPS Product Specifications

BPFT-2460 / PLASTIC FLIP-N-STORE TABLES

- Tops are made of lightweight HDPE blow molded plastic.
- Tops are furnished with two grommet holes for wire management.
- Equipped with dual levers, allowing for easy tabletop folding
- Tables nest together for space-saving storage.
- Frame and legs are made of grey hammer-tone powdercoated steel and includes a perforated steel modesty panel for an attractive design.
- Modesty panel features a built-in cable channel to conceal wires.
- Tables are equipped with four 2" casters (two locking) making them easy to roll.
- Tables tested to support up to 700 lbs. and are guaranteed for ten years.
- MAS certified Green®
- Tables are lightweight weighing only 46 lbs. and are easy to assemble.
- Opened dimensions are 60"L x 24"W x 29½"H
- Folded dimensions are 43½"H x 60"L x 24½"W
- Tabletop thickness: 1¾"
- Gauge of steel: 16 gauge
- Carton dimensions are 60 3/4"L x 24 3/4" W x 4 3/4" D. Carton weight 50 lbs.
- Ships with UPS oversize or by truck at class 125.
- Available Colors: ■ Grey ■ Charcoal

BPFT-2472 / PLASTIC FLIP-N-STORE TABLES

- Tops are made of lightweight HDPE blow molded plastic.
- Tops are furnished with two grommet holes for wire management.
- Equipped with dual levers, allowing for easy tabletop folding
- Tables nest together for space-saving storage.
- Frame and legs are made of grey hammer-tone powdercoated steel and includes a perforated steel modesty panel for an attractive design.
- Modesty panel features a built-in cable channel to conceal wires.
- Tables are equipped with four 2" casters (two locking) making them easy to roll.
- Tables tested to support up to 700 lbs. and are guaranteed for ten years.
- MAS certified Green®
- Tables are lightweight weighing only 52 lbs. and are easy to assemble.
- Opened dimensions are 72"L x 24"W x 29½"H
- Folded dimensions are 43½"H x 72"L x 24½"W
- Tabletop thickness: 1¾"
- Gauge of steel: 16 gauge
- Carton dimensions are 72 ¾"L x 24 ¾" W x 4 ¾" D. Carton weight 56.
- Ships with UPS oversize or by truck at class 125.
- Available Colors: ■ Grey ■ Charcoal

BMFIH3072 / PLASTIC FOLD-IN-HALF TABLES

- Open dimensions 71.8"L x 30"W x 29.5"H
- Folded dimensions 36"L x 30"W x 3.75"D
- Frame color Speckled grey
- Frame specifications- 19 gauge powder coated steel
- Leg specifications- 1 1/8 round 19 gauge tubing
- 700 lb. weight capacity
- Tabletop specifications - 1.5" High-Density Polyethylene (HDPE)
- Tabletop color - Grey
- Table weight 33 lbs.
- Carton weight 37 lbs.
- Carton Dimensions - 37" x 31" x 4.75"
- Ships with UPS
- Ships FOB Memphis TN
- 700lb. distributed weight capacity
- BIFMA tested
- Shipping class 70

MAX SEATING™ FOLDING TABLES

- 4 Tabletop Options:
 - .75" thick premium plywood tabletop with 3mm PVC edge
 - .75" thick premium plywood tabletop with Protect Edge
 - .75" thick Particleboard with T-molding
 - .75" thick premium plywood tabletop with T-molding
- Clear acrylic tabletop surface (on plywood core only) or HPL.
- 16 gauge C-channel frame design with textured black powdercoating
- 16 gauge frame joining plates
- Legs are made from 14 gauge 1.25" square leg tubing

- Legs are positioned at table corners to enable Max Seating™
- 2-point welded leg brace
- Auto-Engage locking mechanism
- Lock requires manual disengagement
- Proprietary leg clips
- 14 gauge Stability-Boost leg brackets
- Nylon stacking corner with standoff
- 16 gauge steel apron joining plates
- High-impact non-marring spring steel flower glides
- Folding legs and Auto-Engage lock tested to exceed 7,000 cycles

HDT HEAVY-DUTY TABLES

- Comes in 6 tabletop options:
 - .75" Standard high pressure laminate top
 - 1.25" Supreme high pressure laminate top
 - 1.25" Whiteboard top
 - 1" Chem-res top
 - .75" Phenolic top
 - 1.75" Butcherblock top
- 50 frame sizes available – Any frame combination using the following width/lengths:
18", 24", 30", 36", 42", 48", 54", 60", 72", 84" and 96".
- 16 gauge steel frame
- 11 gauge steel brackets
- Legs are built with 14 gauge thick 1 ½" square tubing
- Leg base is fastened to tabletop with 4 heavy-duty screws and gets inserted into the frame using a strong welded hangar bolt
- Legs connect to the frame corner brackets with industrial-grade nylon-insert lock nuts
- Adjustable and fixed height leg options
- Adjustable legs adjust in 1" increments, and are locked firmly in place with 2 k-9 external tooth lock washers and heavy-duty tamper-free hex screws.
- Fixed height leg is 28.5"H (without tabletop)
- Adjustable legs are 21.25"-36.25"H (without tabletop)
- Legs come standard with simple-adjust glides that can add an additional .75"H, and have a caster option.
- 2 peg boards, and a set of 50 variety pegs included in optional peg board set
- Peg boards available for 24" and 30" wide tables
- Peg boards are 16 gauge steel, and pegs are 7 gauge steel
- 4 13-gauge steel gussets and 4 3" heavy duty casters included in optional caster/gusset kit
- Gussets are included with all tables 31" & wider, and 73" and longer, and are recommended when using any table above 30" high
- All parts available with Textured black and Soft Grey powdercoating

HIGH PRESSURE LAMINATE TOP:

- Resistant to:

1	Distilled water	8	Fresh tea
2	50:50 Ethyl alcohol	9	Catsup
3	Acetone	10	Yellow mustard
4	Household ammonia	11	10% Povidone iodine
5	10% Citric acid	12	Black Permanent Marker
6	Vegetable oil	13	#2 pencil
7	Fresh coffee	14	Wax crayon
		15	Black paste shoe polish

Chem-Res Top:

- Black, Chem-Res high-pressure laminate top on a 1" thick core. Resistant to 13 chemicals:

NPS Product Specifications

NO.	CHEMICAL COMPOUND	CHEMICAL NAME	STAIN GRADE	TEST METHODS
1	NaOH (40%)	Sodium Hydroxide	0	NEMA LD3-2005
2	H ₂ O ₂ (3%)	Hydrogen Peroxide	0	NEMA LD3
3	HCl (37%)	Hydrochloric Acid	0	NEMA LD3
4	CH ₃ COOH (99%)	Acetic Acid	0	NEMA LD3
5	H ₂ SO ₄ (98%)	Vitriol	0	NEMA LD3
6	HNO ₃ (65%)	Nitric Acid	0	NEMA LD3
7	H ₃ PO ₄ (85%)	Phosphoric Acid	0	NEMA LD3
8	HF (48%)	Hydrofluoric Acid	0	NEMA LD3
9	Formaldehyde (37%)	Formallin	0	NEMA LD3
10	NH ₄ OH (25%)	Ammonia	0	NEMA LD3
11	Phenol	Phenol	0	NEMA LD3 - 2000
12	Na ₂ S	Saturated Sodium Sulfide	0	NEMA LD3 - 2000
13	CCl ₄	Carbon Tetrachloride	0	NEMA LD3 - 2000

Phenolic Top:

- Black, solid 3/4 phenolic resin composite thermo-fused under heat and pressure to form a solid black chemical resistant panel.
- Highly impervious to most chemicals, acids, corrosions, stains and moisture.
- Meant for tough use, comparable to Epoxy Resin tops, Emission free, UV Resistant
- Solid phenolic throughout allowing for easy care and maintenance
- Resistant to:

CHEMICAL NAME	CHEMICAL NAME
Acetate, Amyl	Hydrofluoric Acid, 48%
Acetate, Ethyl	Hydrogen Peroxide
Acetic Acid 98%	Iodine Tincture of
Acetone	Methyl Ethyl Ketone
Acid Dichromate, 5%	Methylene Chloride
Alcohol, Butyl	Mono Chlorobenzene
Alcohol, Ethyl	Naphthalene
Alcohol, Methyl	Nitric Acid, 30%
Ammonium Hydroxide	Phenol, 90%
Benzene	Phosphoric Acid, 85%
Carbon Tetrachloride	Silver Nitrate Saturated
Chloroform	Sodium Hydroxide 10%
Chromic Acid, 60%	Sodium Hydroxide 20%
Cresol	Sodium Hydroxide 40%
Dichloro Acetic Acid	Sulfuric Acid 33%
Dimethylformamide	Sulfuric & Nitric Acids
Dixane	Sulfuric & Nitric Acids mix 77%, 70%
Ethyl Ether	Zinc Chloride Saturated
Formaldehyde	
Furfural	

SLT1 / SLT2

SCIENCE LAB TABLE WOOD LEGS SERIES

- Tops are available in Phenolic, Chem-res, High Pressure Laminate, Whiteboard, Epoxy and Trespa
- Patent Pending Personal Lab Tables available
- 30"H & 36"H tables available in 24", 30" and 42" width
- 24"W table available in 30", 48", 54", 60" and 72" lengths
- 30"W table available in 60" and 72" lengths
- 42"W table available in 60" and 72" lengths
- Solid ash legs and apron
- Optional book compartments measuring 14 1/4"L x 12 3/4"D x 4"H
- Legs attach with metal on metal double bolt through assembly on 13-gauge steel corner braces
- Legs come standard with adjustable glides for accurate leveling and rubber liquid protecting boots
- Set of 4 3" heavy duty casters available for all tables, and includes a stretcher and braces for added support.
- Stretcher and braces are included with all tables 31" & wider, and 73" and longer

SLT3 / SLT7 / SLT8 / SLT9

SCIENCE LAB TABLE STEEL LEG SERIES

- Tops are available in Phenolic, Chem-res, High Pressure Laminate, Whiteboard, Epoxy and Trespa
- Patent Pending Personal Lab Tables available
- 16 gauge steel frame

- 11 gauge steel brackets
 - Legs are built with 14 gauge thick 1 1/2" square tubing
 - Leg base is fastened to tabletop with 4 heavy-duty screws and gets inserted into the frame using a strong welded hangar bolt
 - Legs connect to the frame corner brackets with industrial-grade nylon-insert lock nuts
 - Adjustable and fixed height leg options
 - Adjustable legs adjust in 1" increments, and are locked firmly in place with 2 k-9 external tooth lock washers and heavy-duty tamper-free hex screws.
 - Fixed height leg is 28.5"H (without tabletop)
 - Adjustable legs are 21.25"-36.25"H (without tabletop)
 - Legs come standard with simple-adjust glides that can add an additional .75"H, and have a caster option.
 - 4 13-gauge steel gussets and 4 3" heavy duty casters included in optional caster/gusset kit
 - Gussets are included with all tables 31" & wider, and 73" and longer, and are recommended when using any table above 30" high
 - All parts available with Textured black and Soft Grey powdercoating
- SEE HEAVY DUTY TABLE SECTION FOR ALL AVAILABLE OPTIONS

SLT4-2448 / SLT4-2454 / SLT4-2460 / SLT4-2472 / SLT4-3060 / SLT5-2448 / SLT5-2454 / SLT5-2460 / SLT5-2472 / SLT5-3060

SIGNATURE SCIENCE TABLES WITH ADJUSTABLE HEIGHT LEGS SERIES

- Tops are available in Phenolic, Chem-Res, or High Pressure Laminate
- Available in 24" & 30" width
- 24"W table available in 48", 54", 60" and 72" lengths
- 30"W table available in 60" length
- Solid ash apron and steel legs in your choice of Laminated Oak or Powdercoated Black
- Optional book compartments measuring 14 1/4"L x 12 3/4"D x 4"H
- Aprons are connected together with four semi-round 14 gauge stainless steel metal brackets
- Legs attach with six 18mm screws
- Table adjusts in 3/4" increments from 27"-42"H (with spacer provided)
- Optional 4 Double wheel locking casters available measuring 2 3/8" x 2 3/8" and are adjustable up to 1/2". Material: Plastic. Color: Black

SLT6-2448 / SLT6-2454 / SLT6-2460 / SLT6-2472 / SLT6-3060

SCIENCE LAB TABLE DESIGNER LEGS SERIES

- Available table tops: Phenolic, Chem-Res, High Pressure Laminate, Butcherblock, Whiteboard
- Patented designer legs adjust in 3/4" increments from 27"-42"H (with spacer provided).
- Legs come standard with simple-adjust glides. Optional casters available.
- 11 gauge leg-bases are fastened to the tabletop with 6 heavy-duty screws
- Under-table hat support provides 500lbs. weight capacity
- Adjustable glides for accurate leveling

MSC2436 / MOBILE SCIENCE CABINET

- 270 degree wrap-around hinges
- Fully oak veneered plywood core cabinet and shelf
- 1-1/4" thick high pressure laminated surface compliant with NEMA standard testing
- 4 heavy duty 4 inch swivel locking casters
- Adjustable height shelf
- Door Lock
- Cabinet Color - Light Oak Veneer
- Tabletop Color - Black HPL
- Product Dimensions - 24"W x 36"L x 36"H
- Product weight 103 lbs.
- Carton weight - 110 lbs.
- Carton Dimensions - 43" x 34" x 8"
- Ships UPS from - NJ
- Freight class 100

NPS Product Specifications

MOBILE TABLES

MOBILE FIXED BENCH TABLE

GENERAL Folding mobile cafeteria table with attached benches shall have a top surface measuring 30" wide and bench surface of 10" wide. The top surface shall be 29" high and bench surface shall be 17" high when opened for use. The overall top length shall be 12'1", 10'1", or 8'1". The overall width of the unit shall be 56". When folded the table shall fit through a 36" wide doorway.

ENTRANCES Each bench unit shall have six walk-in entry points. Benches shall be attached to the table structure in a manner that does not significantly obstruct the user from entering from either end or between the benches. The center leg bench support shall be an offset double tube design thus eliminating a trip point during entry. End leg metal components located near the floor, where feet may come into contact with them shall be chrome plated. All other metal frame components should be epoxy powder coated or chrome option.

LOCKING - OPENING A gravity lock shall automatically lock the table into the open position. The lock is disengaged manually, capable of operating from both sides of the table. The table design shall feature a midway position lock to secure the unit in a partially folded position for ease of movement during floor cleaning and to prevent finger/hand pinching. The lock rod shall be 7/16" diameter and chrome plated to resist wear.

LOCKING - FOLDING A storage lock shall automatically lock the table in the folded storage position. The lock is disengaged manually, capable of operating from both sides of the table within easy reach. Easy opening and closing via a perfectly balanced torsion bar system. Each unit will include 4, 3, or 2 torsion bars determined by table size and core material.

TABLE AND BENCH TOPS Table and bench tops shall be surfaced with high pressure laminate bonded to a ¾" thick MDF core, sealed underneath with a phenolic backer sheet. Bench shall be surfaced with high pressure laminate bonded to a ¾" thick MDF core, sealed underneath with a phenolic backer sheet. Edge of the tops and benches shall be sealed with ProtectEdge, a polyurethane epoxy resin, chemically bound to the edge of the laminate, core and phenolic backing sheet.

Optional Plywood core with ProtectEdge: Table and bench tops shall be surfaced with high pressure laminate bonded to a ¾" thick AC grade plywood core, sealed underneath with a phenolic backer sheet. Edge of the tops and benches shall be sealed with a polyurethane epoxy resin, ProtectEdge, chemically bound to the edge of the laminate, core and backing sheet.

Optional Plywood Core with Vinyl T-molding: Table and bench tops shall be surfaced with high pressure laminate bonded to a ¾" thick AC grade plywood core, sealed underneath with a poly resin backer sheet. Edge of the tops and benches shall be banded with vinyl T-molding, secured by staples to the tops underside approximately every 10".

Optional Particleboard Core with Vinyl T-molding: Table and bench tops shall be surfaced with high pressure laminate bonded to a ¾" thick 47 lb. particleboard core, sealed underneath with a poly resin backer sheet. Edge of the tops and benches shall be banded with vinyl T-molding, secured by staples to the tops underside approximately every 10".

TABLE TOP SUPPORT Each top shall be supported by two 1 7/8" deep, 14-gauge steel aprons. Apron shall contain no holes greater than ½" diameter. Aprons shall be capped at the ends with riveted plastic protectors. Each top shall be supported across the width of the top in at least two places.

LEG ASSEMBLIES Leg assemblies shall have vertical tubes supporting the benches and shall be constructed of 1½" diameter, 14-gauge steel tubing with 11-gauge tubing used on the base of the end leg assemblies. Caster lift-off shall be constructed of 14-gauge chrome plated rectangular steel. All other tubular components shall be 1.05" diameter, 14-gauge steel tubing, or structural members of equal or greater strength. Non-marring glides are glass infused nylon that is captured inside the leg tube with spring clips to stay in place.

CASTERS Casters shall be heavy-duty, double ball bearing type with a minimum rated load capacity of 275 lbs. each. Casters should have hard rubber non-marking wheels 4" diameter x 1½" wide.

SAFETY REQUIREMENTS Bench units shall be safety tested and listed by Underwriter's Laboratories, Inc. Bench units must display UL labels with valid UL file number. When bench unit is opened for use, all casters shall lift off the ground automatically to minimize table movement while in use. Casters that protrude past the end of the bench unit when opened for use, are prohibited to prevent tripping hazard. Bench units shall have no moving parts that can pinch, cut or pierce the operator's hand while the table is being folded up and down. There shall be at least a 1" gap between the inner leaves of the table tops to prevent pinched fingers.

WARRANTY MTFB units covered by 15-year warranty.

MOBILE STOOL TABLE

GENERAL Folding mobile cafeteria table with attached stools shall have a top surface measuring 30" wide. The top surface shall be 29" high and bench surface shall be 17" high when opened for use. The overall top length shall be 12'1", 10'1", or 8'1". Leg assemblies shall be chrome plated or epoxy powder coated. When folded the table shall fit through a 36" wide doorway.

ENTRANCES Each stool position shall have its own entrance clear of obstructions when entering the unit to sit down. Stool units having support members running across the entrance area are not acceptable.

LOCKING - OPENING A gravity lock shall automatically lock the table in the open position. The lock is disengaged manually, capable of operating from both sides of the table. The table design shall feature a midway position lock to secure the unit in a partially folded position for ease of movement during floor cleaning and to prevent finger or hand pinching. The lock rod shall be 7/16" diameter and chrome plated to resist wear.

LOCKING - FOLDING A storage lock shall automatically lock the table in the folded storage position. The lock is disengaged manually, capable of operating from both sides of the table within easy reach. Easy opening and closing via a perfectly balanced torsion bar system. Each unit will include 5, 4, 3, or 2 torsion bars determined by table size and core material.

TABLE TOPS Table tops shall be surfaced with high pressure laminate bonded to a ¾" thick MDF core, sealed underneath with a phenolic backer sheet. Edge of the tops shall be sealed with ProtectEdge, a polyurethane epoxy resin, chemically bound to the edge of the laminate, core and phenolic backing sheet.

Optional Plywood core with ProtectEdge: Table tops shall be surfaced with high pressure laminate bonded to a ¾" thick AC grade plywood core, sealed underneath with a phenolic backer sheet. Edge of the top shall be sealed with a polyurethane epoxy resin, ProtectEdge, chemically bound to the edge of the laminate, core and phenolic backing sheet.

Optional Plywood Core with Vinyl T-molding: Table tops shall be surfaced with high pressure laminate bonded to a ¾" thick AC grade plywood core, sealed underneath with a poly resin backer sheet. Edge of the top shall be banded with vinyl T-molding, secured by staples to the tops underside approximately every 10". **Optional Particleboard Core with Vinyl T-molding:** Table tops shall be surfaced with high pressure laminate bonded to a ¾" thick 47 lb. particleboard core, sealed underneath with a poly resin backer sheet. Edge of the top shall be banded with vinyl T-molding, secured by staples to the tops underside approximately every 10".

TABLE TOP SUPPORT Each top shall be supported by two 1 7/8" deep, 14-gauge steel aprons. Apron shall contain no holes greater than ½" diameter. Apron shall contain no holes greater than ½" diameter. Aprons shall be capped at the ends with riveted plastic protectors. Each top shall be supported across the width of the top in at least two places.

LEG ASSEMBLIES Tubular leg components shall be 1.05" and 1½" diameter, 14-gauge steel tubing. Legs and stool columns shall be constructed of 1½" diameter, 14-gauge steel tubing and shall be braced horizontally to the stool support column on the opposite side of the table to resist bending. Units with stools braced from the floor are not acceptable. Non-marring glides are glass infused nylon that is captured inside the tube with spring clips to stay in place.

STOOLS Stools shall be injection molded with a minimum of 25 oz. of rubber modified, high impact polystyrene materials measuring 13" in diameter. Stools shall be reinforced to resist failure with a minimum of 12 integrally molded, tapered ribs. Ribs shall extend from the outer parameter of the stool to the mounting hub at the center of the stool. Stools shall be mounted with 5/16" diameter bolts and locking nuts with fender washers. Spring pins are not acceptable.

CASTERS Casters shall be heavy-duty, double ball bearing type with a minimum rated load capacity of 275 lbs. each. Casters should have hard rubber non-marking wheels 4" diameter x 1½" wide.

SAFETY REQUIREMENTS Stool units shall be safety tested and listed by Underwriter's Laboratories, Inc. Stool units must display UL labels with valid UL file number. When stool unit is opened for use, all casters shall lift off the ground automatically to minimize table movement while in use. Casters that protrude past the end of the stool unit when opened for use, are prohibited to prevent tripping hazard. Stool units shall have no moving parts that can pinch, cut or pierce the operator's hand while the table is being folded up and down. There shall be at least a 1" gap between the inner leaves of the table tops to prevent pinched fingers.

WARRANTY MTS units covered by 15-year warranty.

MOBILE SHAPE BENCH, STOOL AND COMBO

GENERAL Folding mobile shape cafeteria table shall offer attached benches, stools, or a combination of both benches and stools. The top surface shall be 29" high while bench and stool surface shall be 17" high when opened for use. Leg assemblies shall be chrome plated or epoxy powder coated. When folded the table shall fit through a 36" wide doorway.

ENTRANCES Each stool position shall have its own entrance clear of obstructions when entering the unit to sit down.

LOCKING - OPENING A gravity lock shall automatically lock the table in the open position. The lock is disengaged manually, capable of operating from both sides of the table. The table design shall feature a midway position lock to secure the unit in a partially folded position for ease of movement during floor cleaning and to prevent finger or hand pinching. The lock rod shall be 7/16" diameter and chrome plated to resist wear.

LOCKING - FOLDING A storage lock shall automatically lock the table in the folded storage position. The lock is disengaged manually, capable of operating from both sides of the table within easy reach. Easy opening and closing via a perfectly balanced torsion bar system. Each unit will include 4 torsion bars. 60" Bench Unit has gas springs.

TABLE AND BENCH TOPS Table and bench tops shall be surfaced with high pressure laminate bonded to a ¾" thick MDF core, sealed underneath with a phenolic backer sheet. Bench shall be surfaced with high pressure laminate bonded to a ¾" thick MDF core, sealed underneath with a phenolic backer sheet. Edge of the tops and benches shall be sealed with ProtectEdge, a polyurethane epoxy resin, chemically bound to the edge of the laminate, core and phenolic backing sheet.

Optional Plywood Core with ProtectEdge: Table and bench tops shall be surfaced with high pressure laminate bonded to a ¾" thick AC grade plywood core, sealed underneath with a phenolic backer sheet. Edge of the tops and benches shall be sealed with a polyurethane epoxy resin, ProtectEdge, chemically bound to the edge of the laminate, core and backing sheet.

Optional Plywood Core with Vinyl T-molding: Table and bench tops shall be surfaced with high pressure laminate bonded to a ¾" thick AC grade plywood core, sealed underneath with a poly resin backer sheet. Edge of the tops and benches shall be banded with vinyl T-molding, secured by staples to the tops underside approximately every 10".

Optional Particleboard Core with Vinyl T-molding: Table and bench tops shall be surfaced with high pressure laminate bonded to a ¾" thick 47 lb. particleboard core, sealed underneath with a poly resin backer sheet. Edge of the tops and benches shall be banded with vinyl T-molding, secured by staples to the tops underside approximately every 10".

TABLE TOP SUPPORT Each top shall be supported by two 1 7/8" deep, 14-gauge steel aprons. Apron shall contain no holes greater than ½" diameter. Aprons shall be capped at the ends with riveted plastic protectors. Each top shall be supported across the width of the top in at least two places.

LEG ASSEMBLIES Tubular leg components shall be 1.05" and 1½" diameter, 14-gauge steel tubing. Legs and bench/stool columns shall be constructed of 1½" diameter, 14-gauge steel tubing and shall be braced horizontally to the stool support column on the opposite side of the table to resist bending. Units with stools braced from the floor are not acceptable. Non-marring glides are glass infused nylon that is captured inside the tube with spring clips to stay in place.

STOOLS Stools shall be injection molded with a minimum of 25 oz. of rubber modified, high impact polystyrene materials measuring 13" in diameter. Stools shall be reinforced to resist failure with a minimum of 12 integrally molded, tapered ribs. Ribs shall extend from the outer parameter of the stool to the mounting hub at the center of the stool. Stools shall be mounted with 5/16" diameter bolts and locking nuts with fender washers. Spring pins are not acceptable.

CASTERS Casters shall be heavy-duty, double ball bearing type with a minimum rated load capacity of 275 lbs. each. Casters should have hard rubber non-marking wheels 4" diameter x 1½" wide.

SAFETY REQUIREMENTS Stool units shall be safety tested and listed by Underwriter's Laboratories, Inc. Stool units must display UL labels with valid UL file number. When stool unit is opened for use, all casters shall lift off the ground automatically to minimize table movement while in use. Casters that protrude past the end of the stool unit when opened for use, are prohibited to prevent tripping hazard. Stool units shall have no moving parts that can pinch, cut or pierce the operator's hand while the table is being folded up and down. There shall be at least a 1" gap between the inner leaves of the table tops to prevent pinched fingers.

WARRANTY MTR units covered by 15-year warranty.

MOBILE TABLE WITHOUT SEATING

GENERAL Folding mobile cafeteria table shall have a top surface consistent with the size/shape specified. The top surface shall be 29" high unless otherwise noted. When folded the table shall fit through a 36" wide doorway.

NPS Product Specifications

ENTRANCES / FRAME Mobile Table units without seating offer open a continuous range of entry points around the table surface perimeter. All other metal frame components should be epoxy powder coated or chrome option.

LOCKING – OPENING A gravity lock shall automatically lock the table into the open storage position. The lock is disengaged manually, capable of operating from both sides of the table. The table design shall feature a midway position lock to secure the unit in a partially folded position for ease of movement during floor cleaning and to prevent finger/hand pinching. The lock rod shall be 7/16" diameter and chrome plated to resist wear.

LOCKING – FOLDING A storage lock shall automatically lock the table in the folded storage position on styles/sizes where applicable. The lock is disengaged manually, capable of operating from both sides of the table within easy reach. Easy opening and closing via a perfectly balanced torsion bar system when applicable. MT48, MT60, MT6072, and MT72 tables are balanced to operate without torsion bars. MTMT8, MT10, and MT12 units shall include 3, 2, or 1 torsion bar(s) determined by table size and core material.

TABLE TOPS Table tops shall be surfaced with high pressure laminate bonded to a ¾" thick MDF core, sealed underneath with a phenolic backer sheet. Edge of the tops shall be sealed with ProtectEdge, a polyurethane epoxy resin, chemically bound to the edge of the laminate, core and phenolic backing sheet.

Optional Plywood core with ProtectEdge: Table tops shall be surfaced with high pressure laminate bonded to a ¾" thick AC grade plywood core, sealed underneath with a phenolic backer sheet. Edge of the tops and benches shall be sealed with a polyurethane epoxy resin, ProtectEdge, chemically bound to the edge of the laminate, core and backing sheet.

Optional Plywood Core with Vinyl T-molding: Table and bench tops shall be surfaced with high pressure laminate bonded to a ¾" thick AC grade plywood core, sealed underneath with a poly resin backer sheet. Edge of the tops and benches shall be banded with vinyl T-molding, secured by staples to the tops underside approximately every 10".

Optional Particleboard Core with Vinyl T-molding: Table and bench tops shall be surfaced with high pressure laminate bonded to a ¾" thick 47 lb. particleboard core, sealed underneath with a poly resin backer sheet. Edge of the tops shall be banded with vinyl T-molding, secured by staples to the tops underside approximately every 10".

TABLE TOP SUPPORT Each top shall be supported by two 1 7/8" deep, 14-gauge steel aprons. Apron shall contain no holes greater than ½" diameter. Apron shall contain no holes greater than ½" diameter. Aprons shall be capped at the ends with riveted plastic protectors as needed.

LEG ASSEMBLIES Leg assemblies shall have vertical tubes supporting the benches and shall be constructed of 1½" diameter, 14-gauge steel tubing. All other tubular components shall be 1.05" diameter, 14-gauge steel tubing, or structural members of equal or greater strength.

CASTERS Casters shall be heavy-duty, double ball bearing type with a minimum rated load capacity of 275 lbs. each. Casters should have hard rubber non-marking wheels 4" diameter x 1¼" wide.

SAFETY REQUIREMENTS MTMT8, MT10, and MT12 Rectangular units shall be safety tested and listed by Underwriter's Laboratories, Inc. Rectangular units must display UL labels with valid UL file number. When unit is opened for use, all casters shall lift off the ground automatically to minimize table movement while in use. Units shall have no moving parts that can pinch, cut or pierce the operator's hand while the table is being folded up and down. There shall be at least a 1" gap between the inner leaves of the table tops to prevent pinched fingers.

WARRANTY MT units covered by 15-year warranty.

MOBILE CONVERTIBLE BENCH UNIT

GENERAL Folding mobile convertible bench unit shall have a top surface measuring 15" wide and a bench surface measuring 12". The top surface shall be 29" high when opened for use. The top and bench length shall be 8' or 7' or 6'. Each unit shall have a bench that can be opened for use and closed for transporting. Each unit shall have a tabletop that can be raised up as a tabletop or lowered as a bench back.

STANDARD: Standard ganging with all units allows joining two tables together securely for cafeteria style seating.

TABLE AND BENCH TOPS: Table and bench tops shall be surfaced with high pressure laminate bonded to a ¾" thick MDF core, sealed underneath with a phenolic backer sheet. Edge of the tops and benches shall be sealed with a polyurethane epoxy resin, ProtectEdge, chemically bound to the edge of the laminate, core and phenolic backing sheet.

Optional Plywood Core with ProtectEdge: Table and bench tops shall be surfaced with high pressure laminate bonded to a ¾" thick AC grade plywood core, sealed underneath with a phenolic backer sheet. Edge of the top and bench shall be sealed with a polyurethane epoxy resin, ProtectEdge, chemically bound to the edge of the laminate, core and backing sheet.

Optional Plywood Core with Vinyl T-molding: Table and bench tops shall be surfaced with high pressure laminate bonded to a ¾" thick AC grade plywood core, sealed underneath with a poly resin backer sheet. Edge of the top and bench shall be banded with vinyl T-molding, secured by staples to the tops underside approximately every 10".

OPTIONAL PARTICLEBOARD CORE WITH VINYL T-MOLDING: Table and bench tops shall be surfaced with high pressure laminated bonded to a ¾" thick 47 lb. particleboard core, sealed underneath with a poly resin backer sheet. Edge of the top and bench shall be banded with vinyl T-molding, secured by staples to the top and bench underside approximately every 10".

TABLE TOP SUPPORT Each top shall be supported by two 1 7/8" deep, 14-gauge steel aprons. Aprons shall contain no holes greater than ½" diameter. Table tops shall be supported with steel gussets at approximately every 30".

LEG ASSEMBLIES Vertical tubes supporting the tabletop and benches shall be constructed of 1½" 14-gauge square tubing. Horizontal tubing for bench supports shall be made of 1 1/8" 14-gauge round tubing. Horizontal tubing shall be fitted to bench with eight 3" x 2" steel plates welded onto 1½" 14-gauge metal tubes. The steel plates shall be connected to underside of bench with five screws. Horizontal leg bottoms shall be constructed of 1½" 14-gauge square tubing and shall be chrome plated. All square and round tubing shall have plastic end closures. Rubber glides include a spring clip inside the square tubing of the leg to insure they stay in place.

GANGING & FOLDING SAFETY A flexible one-piece molded UV resistant glass-filled nylon draw latch shall be mounted to the outside of each apron. Two units facing together shall be quickly locked together at each end of the table for cafeteria-type seating configurations. The latch shall lock against the apron for storage when not in use. An embedded pin in the leg system will prevent finger pinching and wear on the table top and bench surface when in a closed storage position.

CASTERS Casters shall be heavy-duty, double ball bearing type with a minimum load capacity of 150 lbs. each. Casters shall have non-marking wheels 3" diameter x 1" wide. Two of the casters shall be locking to keep unit in place while in use.

SAFETY REQUIREMENTS Units shall be safety tested and listed by Underwriter's Laboratories, Inc. Units must display UL labels with valid UL file number. Unit shall have no moving parts that can pinch, cut or pierce the operators hands while the tabletop or benches is being folded up or down. The exclusive embedded pin design will prevent pinching.

WARRANTY CB units are covered by a 15 year warranty.

EASYFOLD MOBILE FLIPPER TABLE

MTSSF-60R/Q/H/O/V MTSSF-48R/Q/H

GENERAL Folding mobile cafeteria table shall have a top surface consistent with the size/shape specified. The top surface shall be 29" high unless otherwise noted. When folded the table shall fit through a 36" wide doorway.

ENTRANCES/FRAME Mobile Table units without seating offer open a continuous range of entry points around the table surface perimeter. All metal frame components should be epoxy powder coated or chrome leg option.

LOCKING - OPENING A gravity lock shall automatically lock the table into the open storage position. The lock is disengaged manually, capable of operating from two locations on one side of the table. The lock rod shall be 7/16" diameter and chrome plated to resist wear. Tamper resistant lock nuts on all down lock assemblies with self-adjusting pawl catch ensure the down lock engages every time.

LOCKING – FOLDING MTSSF-60R/Q/H/O/V tables are balanced to operate with a gas/oil filled spring. The design of the table remains locked into the folded position without until the user begins to open the table manually.

TABLE TOPS Table tops shall be surfaced with high pressure laminate bonded to a ¾" thick MDF core, sealed underneath with a phenolic backer sheet. Edge of the tops shall be sealed with Protect Edge, a polyurethane epoxy resin, chemically bound to the edge of the laminate, core and phenolic backing sheet. Tamper resistant table top screws provide superior holding power to frame with the ability to be serviced easily in the field.

Optional Plywood core with Protect Edge: Table tops shall be surfaced with high pressure laminate bonded to a ¾" thick AC grade plywood core, sealed underneath with a phenolic backer sheet. Edge of the tops and benches shall be sealed with a polyurethane epoxy resin, Protect Edge, chemically bound to the edge of the laminate, core and backing sheet.

Optional Plywood Core with Vinyl T-molding: Table and bench tops shall be surfaced with high pressure laminate bonded to a ¾" thick AC grade plywood core, sealed underneath with a poly resin backer sheet. Edge of the tops and benches shall be banded with vinyl T-molding, secured by staples to the tops underside approximately every 10".

Optional Particleboard Core with Vinyl T-molding: Table and bench tops shall be surfaced with high pressure laminate bonded to a ¾" thick 47 lb. particleboard core, sealed underneath with a poly resin backer sheet. Edge of the tops shall be banded with vinyl T-molding, secured by staples to the tops underside approximately every 10".

TABLE TOP SUPPORT Each top shall be supported by two 1 7/8" deep, 14-gauge steel apron uni-frame design. Apron shall contain no holes greater than ½" diameter. Apron shall contain no holes greater than ½" diameter. Tamper resistant table top screws provide superior holding power to frame with the ability to be serviced easily in the field.

LEG ASSEMBLIES Leg assemblies shall have vertical tubes (round) supporting the tables and caster lift off tubes (square) shall be constructed of 1½" diameter, 14-gauge steel tubing. All other tubular components shall be 1.05" diameter, 14-gauge steel tubing, or structural members of equal or greater strength. Tamper-proof non-marring nylon steel insert glides and tube closures will not break or fall out.

CASTERS Jarvis Casters shall be heavy-duty 4" diameter x 1¼" wide double ball swivel, non-marring with a minimum rated load capacity of 275 lbs. each. To minimize unnecessary table movement once in place, casters shall lift off the ground as table transitions from folded to open in-use position.

SAFETY REQUIREMENTS When unit is opened for use, all casters shall lift off the ground automatically to minimize table movement while in use. Units shall have no moving parts that can pinch, cut or pierce the operator's hand while the table is being folded up and down.

CERTIFICATIONS Cafeteria Tables have been tested to pass MAS Green® Certification.

WARRANTY Cafeteria Tables are warranted against manufacturer's defects for 15 years.

TGT2448PBTM/TGT2460PBTM/TGT3048PBTM/TGT3060PBTM/ TGT2448MDPE/TGT2460MDPE/TGT3048MDPE/TGT3060MDPE

TOGO MOBILE TABLE

- Available in 4 sizes: 24" x 48", 24" x 60", 30" x 48", 30" x 60"
- Table core options: MDF/ PARTICLEBOARD
- Table Edge options: PROTECT EDGE/ VINYL T-MOLDING
- Frame Color: Powder Coated
- Heavy duty magnet
- 14 gauge steel frame
- Easy nesting and storage
- Laminate color options: Grey Nebula, Montana Walnut, Banister Oak, Wild Cherry, Fusion Maple, Marigold, Hollyberry, Persian Blue

NPS Product Specifications

TGB48PBTM/TGB60PBTM/TGB48MDPE/TGB60MDPE

TOGO MOBILE BENCH

- Available in 2 Sizes: 25" x 48", 25" x 60"
- Table core options: MDF / PARTICLEBOARD
- Table Edge options: PROTECT EDGE/ VINYL T-MOLDING
- Frame Color: Powder Coated
- 14 gauge steel frame
- Easy nesting and storage
- Laminate Surface or Padded option available

CAFÉ

BCC/BCS SERIES / BUSHWICK CAFÉ CHAIR AND STOOL

- 8 layer bent plywood seat with a high end HPL finish
- Legs are made of 7/8 in. 16 gauge chrome tubing.
- Modern handle for easy movement and storage.
- 4 fully welded 12 gauge under-seat support brackets
- Heavy duty bumpers for safe and secure stackability
- Durable non-marring polypropylene glides
- Weight Capacity Exceeds 500 lbs
- Plywood core is made with poplar wood and eucalyptus wood
- Available colors: ■ Natural ■ Espresso

CT SERIES / FIXED HEIGHT CAFÉ TABLE

- 1 1/4" High Pressure Laminate tops with T-Mold available in standard and custom colors
- Available in round, square, rectangle, racetrack, and curved in a variety of sizes
- Legs available in X-base, T-base, or round base
- Legs come with 1/2" thick non-marring polypropylene mushroom leveling glides to prevent floor scratching
- Pole connects to base with 1 heavy-duty bolt with thread locker
- Textured Black Powder Coated Frame
- 16 gauge 3" thick pole
- 8 gauge steel base
- 12 gauge support plate is fully welded to base for extreme stability
- 300 lbs Weight Capacity

PCT / PREMIUM PLUS CAFE TABLES

- High pressure laminate and whiteboard tabletops are easy to clean and will resist scratches.
- Available in both round and square shapes in 24", 30" & 36" size tops.
- Tables adjust from 30" to 42" using a smooth and easy to adjust pneumatic lever.
- Heavy-duty 13 gauge steel column and 1/2 inch steel base.
- 3" Heavy-Duty Polyurethane non-marring locking swivel casters.
- Table top folds and locks into place and can be nested with other tables for safe compact storage.
- ANSI/BIFMA certified meeting all TSCA title VI requirements
- Blowmolded Top: Charcoal Slate
- Available laminate colors: ■ Grey Nebula ■ Montana Walnut ■ Banister Oak ■ Wild Cherry ■ Fusion Maple ■ Marigold ■ Hollyberry ■ Persian Blue

CTT3042 / ADJUSTABLE HEIGHT CAFE TABLE

- Tabletops are made of lightweight charcoal colored HDPE blow molded plastic.
- Tabletop measures 36"x 36"
- Tabletop thickness: 1 3/8"
- Features 12" of pneumatic height adjustment from 30" - 42"
- Tabletops flip and tables nest together for space-saving storage
- Table frame, column and base are made of silver-tone powdercoated steel
- Gauge of steel: 16 gauge
- Tables tested to support up to 700 lbs. and are guaranteed for ten years.
- Furnished with plastic adjustable floor levelers
- MAS certified Green®
- Tables are lightweight weighing only 32 1/2" lbs. and are easy to assemble
- Carton dimensions are 36 1/2" L x 36 1/2" W x 4" D. Carton weight: 37 lbs.
- Ships with UPS or by truck at class 125.

CTS30 / BISTRO HEIGHT CAFE STOOL

- Seats and back are made of lightweight charcoal colored HDPE blow molded plastic.
- Seat height is 30"
- Seat size is 17" x 16"
- Seat thickness is 2 1/8"
- Back size is 18 1/8" W x 9" H x 1 1/8" D
- Overall height is 42"
- Frames are made of silver-tone powdercoated 1-1/8" steel
- Gauge of seat frame: 16 gauge
- Gauge of legs: 18 gauge
- Assembled width & depth: 22 3/4" W x 19 3/4" D
- Furnished with rubber floor friendly glides for floor protection.
- Stools are guaranteed for ten years.
- MAS certified Green®
- Stools are lightweight weighing only 12 1/2" lbs.
- Carton dimensions are 20 1/2" W x 23" D x 42 1/2" H. Carton weight: 17 lbs.
- Ships with UPS or by truck at class 300.
- Max stacking capacity: 3
- 300 lbs Weight Capacity

CLT SERIES/ COLLABORATOR TABLE

- Available with a 1 1/4" HPL, 1 1/4" Butcherblock or Whiteboard Industrial Grade top.
- Available in dining height (30") as well as bar height (42").
- Bar Height tables include crossbeam for extra stability.
- 5 gauge support plates
- Solid 8 gauge Industrial grade frame
- 2 leveling glides on each base
- Powder-Coated Black Santex Frame
- 500 lbs Weight Capacity

MUSIC

82MS / MUSIC STAND

- Durable 22-gauge aluminum surface is 20 1/2" wide and features safe rolled edges to prevent harm to instruments or people.
- Black textured finish resists chips and scratches
- Adjustable desk angle and height from 24 to 46 (from bookrest lip to floor) with the spring-loaded tube.
- Stand Is 18-Gauge, 1" O.D. Steel
- Tension Tilt Surface For Smooth Adjustment And Holds Strong In Any Position
- Powder-Coated In Black To Match Melody Music Chair
- New Rubber Tips Included To Prevent Noise And Floor Scratching
- New Attachment Style Eliminates The Need For Bolt Tightening
- 50mm thread lock base bolt and enhanced lock washer prevent the pole from loosening at the base.

SERIES 8200 / MELODY STACK CHAIR / MELODY STACK CHAIR JR.

8210 DIMENSIONS: 33 1/2"H X 19"W X 21 1/2"D
SEAT (8210): 17 1/2"H X 16 1/2"W X 16 1/2"D
OPTIONAL TABLET ARM WITH PLYWOOD CORE FLIPS UP TO FOLD BEHIND CHAIR: 13 3/4"W X 17"D X 1/2"H

8210-16 DIMENSIONS: 31 1/2"H X 19"W X 21 1/2"D
SEAT (8210-16): 16"H X 16 1/2"W X 16 1/2"D
OPTIONAL TABLET ARM WITH PLYWOOD CORE FLIPS UP TO FOLD BEHIND CHAIR: 13 3/4"W X 17"D X 1/2"H

- Features a 7/8" powder coated paint frame with 16-gauge square tubing
- 14-gauge rear seat brace
- Band-pitch style with a seat back angle of 97 degrees
- Durable Polypropylene contoured seat for extra comfort
- Can be stacked 18 high on our DY-82 with 4 stack bumpers to protect finish
- Weighs 12 lbs
- 300 lbs Weight Capacity
- Available Colors: ■ Black

DYMS10 / DOLLY FOR 82MS MUSIC STANDS

DIMENSIONS: OVERALL: 47"H X 27"W X 31"L

- Strong 15-gauge steel frame in chrome for long-lasting performance
- 10 stand capacity

NPS Product Specifications

- Large wheels measure 2" x 8" and small wheels are 3/4"x2"
- Handles are covered in soft rubber for extra comfort
- Plastic covering on holding arm for added protection
- Lightweight design it is easy to move a fully loaded unit up and down stairs
- Ship weight: 29lbs.

DYMS20 / DOLLY FOR 82MS MUSIC STANDS

DIMENSIONS: OVERALL: 27"W X 47"H X 59"L

- Strong 15-gauge steel frame in chrome for long-lasting performance
- Large stationary casters measure 2"x8" and small swivel casters measure 1"x5"
- 20 stand capacity
- Handles are covered in soft rubber for extra comfort
- Plastic covering on holding arm for added protection
- Ship weight: 48lbs.

STAGES & RISERS

PERFORMANCE STAGES AND SEATED RISERS

INCLUDES 36"W AND 48"W STAGES STAGE PIECES, STAGE PIES, & STAGE SETS

- Constructed with 3/4" solid plywood core
- Available with carpet in choice of 4 colors or 1/8" thick tempered hardboard
- 16-gauge, 1-13/16" high formed steel channel frame reinforced with 16-gauge steel angle welded to the inside of the channel
- 14-gauge steel tubing capped at the point of floor contact with high impact plastic glides
- Legs open and close using only one hand
- Stages and risers equipped with drop-in couplings that allow units of same or different heights to be joined together
- All ganging devices are permanently secured to each unit
- Exceeds 200 lbs. per square foot load bearing capacity
- Available in 36" and 48" widths
- Comes in 4 heights; 8", 16", 24" and 32"
- Skirting available for all stages in 2 styles; shirred pleat and box pleat
- Optional Stage Pies for semi-circle arrangements
- 3 step heights available to connect to 16"H Stages and above
- Optional Guardrails recommended for safety. Guardrails are 14-gauge
- 10-year warranty

TFX STAGES / ADJUSTABLE HEIGHT STAGES

- Constructed with 3/4" solid plywood core
- Available with carpet in choice of 4 colors or 1/8" thick tempered hardboard
- 16-gauge, 1-13/16" high formed steel channel frame reinforced with 16-gauge steel angle welded to the inside of the channel
- 14-gauge steel tubing
- Legs open and close using only one hand
- Stages equipped with drop-in couplings that allow units of same or different heights to be joined together
- All ganging devices are permanently secured to each unit
- Exceeds 200 lbs. per square foot load bearing capacity
- Stages measure 48"x48" or 48"x96" and are available in two adjusting sizes - 16"-24" and 24"-32"
- Adjustable legs are made of plated 14 gauge steel and are capped with high impact plastic glides
- Stage rolls on two 2" rubber casters for easy mobility
- Legs are equipped with clevis pins to lock adjusting legs in place
- Skirting available in 2 styles; shirred pleat and box pleat
- 3 step heights available to connect to 16"H Stages and above
- Optional Guardrails recommended for safety. Guardrails are 14-gauge
- 10-year warranty

CHORAL RISERS / RS AND RT SERIES

- Constructed with 3/4" solid plywood core
- Available with carpet in choice of 4 colors or 1/8" thick tempered hardboard
- 16-gauge, 1-13/16" high formed steel channel frame reinforced with 16-gauge steel angle welded to the inside of the channel
- 14-gauge steel tubing capped at the point of floor contact with high impact plastic glides
- Legs open and close using only one hand
- Nylon 6 glides + 30% glass fiber (PA6-630)
- Equipped with drop-in couplings that allow units of same or different heights to be joined together

- All ganging devices are permanently secured to each unit
- Exceeds 200 lbs. per square foot load bearing capacity
- Comes in 4 heights; 8", 16", 24" and 32"
- Straight and Tapered units for continuous and semi-circle configurations
- Optional Guardrails recommended for safety
- 10-year warranty

TRANS-PORT RISER

- Available in three 18" wide levels; 8", 16" and 24" high that are permanently joined with hinge mechanisms to enable the unit to open and close in a unified fashion
- Each unit is equipped with wheels for easy transportation when folded and to allow for easy positioning after set up
- Riser levels supported by a 3" deep, double walled, extruded anodized aluminum frame that overlaps the top of each level to protect the carpet edge
- Riser platforms constructed of 3/4" plywood, surfaced with polyolefin carpet
- Optional guardrails constructed of black epoxy powder-coated tubular steel and equipped with clamp-on attachments for easy installation
- Straight or Tapered units available for various configurations
- Now avail: 4th Level Add-On: TPA: 18-1/8"W x 72 1/2"L x 32 1/2"H TPRA: 18"W x 79"L x 32 1/2"H
- Standing Capacity: TP72: 15-18 adults (with 4th level TPA: 20-23) TPR72: 11-14 adults (with 4th level TPRA 16-19)
- 10-year warranty

STAGE ACCESSORY PARTS

STP16/STP24/STP32 / STEPS FOR STAGES

DIMENSIONS: STP16: 36"W X 14"D X 42"H, 42 LBS. STP24: 36"W X 28"D X 48"H, 72 LBS.
STP32: 36"W X 42"D X 54"H, 110 LBS.

- Made of high grade plywood edged with vinyl t-molding
- Frame is powdercoated in black
- Steps coated with Polypropylene textured surface
- Color of steps is grey
- Frame is built with 14 gauge steel tubing
- Unit rolls on two wheels

GRR24S/GRR32S/GRR24T/GRR32T / BACK GUARDRAILS FOR RISERS

DIMENSIONS: GRR24S 94"L X 66"H, 51 LBS. GRR32S 94"L X 74"H, 55 LBS. GRR24T 70"L X 66"H, 40 LBS. GRR32T 76"L X 74"H, 43 LBS.

- For use with Straight & Tapered Risers
- Top and bottom horizontal tubes are 1 1/2" O.D.
- Black powdercoated steel
- Middle horizontal tubes are 1" O.D.
- All tubes are 1 4 gauge steel
- Ends of tubes are outfitted with high impact plastic flower end-caps.
- Vertical tubes are 1 1/4" O.D.

GRTPR3 / GRTPR4 / BACK GUARDRAILS FOR TRANS-PORT RISER

DIMENSIONS: GRTPR3 70 1/2"L X 66 1/4"H, 69 LBS. GRTPR4 70 1/2"L X 74 1/4"H, 75 LBS.

- For use with Straight & Tapered Trans-port Risers
- Top and bottom horizontal tubes are 1 1/2" O.D.
- Black powdercoated steel
- Middle horizontal tubes are 1" O.D.
- All tubes are 14 gauge steel
- Ends of tubes are outfitted with high impact plastic flower end-caps.
- Vertical tubes are 1 1/4" O.D.

SGRTP3 / SGRTP4 / SIDE GUARDRAILS FOR TRANS-PORT RISERS

DIMENSIONS: GSGRTP3 59 1/4"L X 63 1/2"H, 10 LBS. SGRTP4 79 1/4"L X 71 5/8"H, 11LBS.

- For use with Straight & Tapered Trans-port Risers
- Vertical and horizontal tubes are 1 1/4" O.D.
- Black powdercoated steel
- Ends of tubes are outfitted with high impact plastic flower end-caps.
- All tubes are 14 gauge steel

NPS Product Specifications

GRS30/GRS36/GRS48 / GUARDRAILS FOR STAGES

DIMENSIONS: GRS30 30"L X 30"H, 12 LBS. GRS36 36"L X 30"H, 13 LBS. GRS48 48"L X 30"H, 15 LBS.

- For use with stages
- Top horizontal tube is 1 ½" O.D.
- Black powdercoated steel
- Middle and bottom horizontal tubes are 1" O.D.
- All tubes are 14 gauge steel
- Ends of tubes are outfitted with high impact plastic flower end-caps.
- Vertical tubes are 1 ¼" O.D.

SGR2L/SGR3L/SGR4L / SIDE GUARD RAILS FOR STANDARD RISERS

DIMENSIONS: SGR2L 37 7/8"L X 30 7/8"H, 8 ¾ LBS. SGR3L 57 1/3"L X 28 5/8"H, 11 LBS. SGR4L 77 ¼"L X 30 7/8"H, 12 LBS.

- For use with standard risers
- Vertical and horizontal tubes are 1 ¼" O.D.
- Black powdercoated steel
- Ends of tubes are outfitted with high impact plastic flower end-caps.
- All tubes are 14 gauge steel

CG28/CG32/CG37/CG44/CG54/CG72/CG81/CG96 / CHAIR GUARDS

DIMENSIONS: CG28 28"L, 3 LBS. CG32 32"L, 3 LBS. CG37 37"L, 3¾ LBS. CG44 44"L, 3¾ LBS. CG54 54"L, 4 LBS. CG72 72"L, 4¾ LBS. CG81 81"L, 5 LBS. CG96 96"L, 5½ LBS.

- For use with stages and stage pies
- Ends of Chair Guards are outfitted with high impact plastic flower end-caps.
- Tube is made of 1" O.D.
- Tube is 14 gauge steel.
- Chair Guards are powdercoated in black.

SDL / STAGE DOLLY

DIMENSIONS CAPACITY: SIX STAGES

- Rolls on four 6" casters
- Can be used for both 36" 48" stages
- Black powdercoated steel
- Built with 14 gauge tubular steel

DIVIDERS

ROBO ROOM DIVIDERS:

Fabric:

- Units are 6' in height
- Available in the following four sizes:
 - 3-Panel (opened length 72")
 - 5-Panel (opened length 118")
 - 7-Panel (opened length 164")
 - 9-Panel (opened length 210")
 - 11-Panel (opened length 256")
- Sound Absorbing PET Panels
- Flame retardant: B1 grade
- Panels are Tackable
- Self-Leveling Casters
- Tech-Lock brakes for End Frame casters
- Full-Length Hinges
- Secure Storage Fastener
- Unique foot-pedal release.
- Position Regulator keeping panels in place
- Heavyweight- non tipping
- Gangable- Join multiple units together to form a long division or substitute room
- Available in the fabric colors: ■ Black ■ Blue ■ Grey

Acrylic:

- Units are 6' in height
- Available in the following four sizes:
 - 3-Panel (opened length 72")
 - 5-Panel (opened length 118")
 - 7-Panel (opened length 164")
 - 9-Panel (opened length 210")
- 3/16-inch clear OPTIX® acrylic

- Self-Leveling Casters
- Tech-Lock brakes for End Frame casters
- Full-Length Hinges
- Secure Storage Fastener
- Unique foot-pedal release.
- Position Regulator keeping panels in place
- Heavyweight- non tipping
- Ganging- Join multiple units together to form a long division or substitute room

LECTERNS

GSL GRAYSTONE LECTERN

DIMENSIONS: READING SURFACE: 22.75"W X 18.25"D
SIDE PULL OUT TRAYS(R&L): 14.25"W X 12"D
FRONT PULL OUT TRAY: 17.5"W X 9.25"D
TOP TWO CABINET SHELVES: 21"W X 14.75"D X 7"H
BOTTOM CABINET SHELF: 21"W X 14.75"D X 12"H
DRAWER: 6.25"W X 15"D X 13.25"H
PRODUCT WEIGHT: 93 LBS.

- Sleek grey plywood provides for a smooth writing surface
- Units roll on four 2" double wheeled hooded casters

GSL-S GRAYSTONE LECTERN WITH SOUND

DIMENSIONS: READING SURFACE: 22.75"W X 18.25"D
SIDE PULL OUT TRAYS(R&L): 14.25"W X 12"D
FRONT PULL OUT TRAY: 17.5"W X 9.25"D
TOP TWO CABINET SHELVES: 21"W X 14.75"D X 7"H
BOTTOM CABINET SHELF: 21"W X 14.75"D X 12"H
PRODUCT WEIGHT: 95 LBS.

- Sleek grey plywood provides for a smooth writing surface
- Units roll on four 2" double wheeled hooded casters
- Built in sound system
- Bluetooth enabled
- Includes a handheld mic with 9' cable and a gooseneck shock mount mic holder
- Amplifier works with OS wireless microphones
- Includes a tie-clip/lapel mic with 10' cable
- Multimedia capabilities include simultaneous usage with two wired and one wireless (optional) microphones

111PLS POWER PLUS LECTERN

COLORS: MAHOGANY, RIBBONWOOD
PRODUCT WEIGHT: 50LBS.
READING SURFACE DIMENSIONS: 20"WX14.35"D
OVERALL DIMENSIONS: 22"WX17"DX46"H

- Power Output: 30 Watts
- Includes One Handheld Mic And One Tie-Clip/Lavaliere Mic
- Flexible Gooseneck Arm
- Input/output Lines For Media Players, Extension Speakers, Recording And Playing Mp3S
- Features A 12.5"Wx4.25"D Storage Shelf
- High Pressure Thermal-Fused Laminate On A MDF Core
- Durable Scratch Resistance Surface

ARISTOCRAT SERIES W/ SOUND

COLORS: MAHOGANY
PRODUCT WEIGHT: 90LBS.
READING SURFACE DIMENSIONS: 23.5"WX17"D
OVERALL DIMENSIONS: 25"WX20"DX46"H

- Includes 50-Watt Multimedia Amplifier
- Two Built In 8"Speakers
- Includes One Handheld Mic And One Tie-Clip/Lavaliere Mic
- Equipped With One Digital Timepiece
- Flexible Gooseneck Arm
- Input/output Lines For Media Players, Extension Speakers, Recording And Playing Mp3S
- High Pressure Thermal-Fused Laminate On A Mdf Core
- Durable Scratch Resistance Surface
- Equipped With Four Roll Casters, Two Locking
- Assembly Required

NPS Product Specifications

800X ORATOR LECTERN

COLORS: MAHOGANY, RIBBONWOOD
PRODUCT WEIGHT: 63LBS.
READING SURFACE DIMENSIONS: 22.5"WX17"D
OVERALL DIMENSIONS: 22"WX17"DX46"H

- Equipped With 40 Watts Multiplayer Amplifier
- Amp has a USB port and Bluetooth capabilities
- Includes One Handheld Mic And One Tie-Clip/Lavalier Mic
- Input/output Lines For Media Players, Extension Speakers, Recording And Playing Mp3S
- Features A 12"X4" Storage Shelf
- Equipped With A Reading Lamp
- Digital Timepiece Included
- High Pressure Thermal-Fused Laminate On A MDF Core
- Durable Scratch Resistance Surface
- Equipped With Four Casters, Two Locking

950/901 COMBO FLOOR SOUND LECTERN

COLORS: MAHOGANY ON WALNUT
PRODUCT WEIGHT: 187LBS.
READING SURFACE DIMENSIONS: 22.5"WX12.6"D
OVERALL DIMENSIONS: 24"WX20.5"DX48"H

- Custom Built-In 75 Watt Multimedia Amplifier
- Four 4" Speakers Mounted In
- For Audiences Up To 7500 People Or 750000 Sq.
- Includes One Handheld Mic And One Tie-Clip/Lavalier Mic
- Input/output Lines For Media Players, Extension Speakers, Recording And Playing MP3
- Three Sizeable Storage Spaces And Two Adjustable Shelves
- Two Locking Doors
- Equipped With Reading Lamp
- Digital Timepiece Included
- Ac Plug And Optional Battery Operation Include

611S FLOOR LECTERN W/ SOUND

COLORS: RIBBONWOOD
PRODUCT WEIGHT: 71LBS.
READING SURFACE DIMENSIONS: 16.25"WX23.6"D
OVERALL DIMENSIONS: 24"WX21"DX46"H

- Equipped With Two Shelves
- High Pressure Thermal-Fused Laminate On A Miff Core
- Durable Scratch Resistant Surface
- Equipped With Four Concealed Casters, Two Locking
- Assembly Required

612S FLOOR LECTERN W/ SCREEN AND SOUND

COLORS: RIBBONWOOD
PRODUCT WEIGHT: 73LBS.
READING SURFACE DIMENSIONS: 16.25"WX23.6"D
OVERALL DIMENSIONS: 24"WX21"DX46"H

- Perfect For Customizing Logos for Institutions and Presentations
- Equipped With a 15" LCD Screen Build Into the Front Of The Unit
- Display Images Uploaded With a SD-Card or Flash DriveIncludes a Remote Control
- High Pressure Thermal-Fused Laminate on A MDF Core
- Durable Scratch Resistant Surface
- Equipped With Four Concealed Casters, Two Locking

22 TABLETOP LECTERN

COLORS: MAHOGANY, MEDIUM OAK, BLACK
PRODUCT WEIGHT: 31LBS.
OVERALL DIMENSIONS: 23.75"WX19.875"DX13.75"H

- Functions On Its Own or In Conjunction With 112 Floor Lectern Base
- Features A Paper/Book Stop
- High Pressure Thermal-Fused Laminate On A particleboard Core
- Durable Scratch Resistant Surface

112 LECTERN BASE

112 LECTERN BASE

COLORS: MAHOGANY, MEDIUM OAK, BLACK
PRODUCT WEIGHT: 50LBS.
OVERALL DIMENSIONS: 21.125"WX17.5"DX33.75"H

- Use with 22 Tabletop Lectern to make a Full Floor Lectern
- Use As An A/V Cart For Presentation Equipment
- Includes Storage Shelf
- Equipped With Four Roll Casters, Two Locking
- Durable Scratch Resistant Surface
- High Pressure Thermal-Fused Laminate On A particleboard Core

222 FULL FLOOR LECTERN

COLORS: MAHOGANY, MEDIUM OAK
PRODUCT WEIGHT: 55LBS.
OVERALL DIMENSIONS: 23"WX16"DX46.5"H

- Features Full Size Reading Surface
- Spacious Shelf for Storage
- Built In Paper/Book Stop
- High Pressure Thermal-Fused Laminate on a Particleboard Core
- Durable ScrDurable Scratch Resistant Surface
- Floor Glides Provided
- Assembly Required
- Optional Caster Kit Available

401S ACRYLIC LECTERN

COLORS: CLEAR
PRODUCT WEIGHT: 55LBS.
OVERALL DIMENSIONS: 24"WX15"DX46"H

- Light Weight and Made From 1/2" And 3/8" Thick Acrylic Plexiglas
- Features a 24"X16" Reading Surface with Book Stop
- Features Convenient 14"X8" Shelf
- Contemporary Style Lectern
- Perfect for Worship and Modern Business Setting

70 LECTERN

COLORS: CHERRY, MEDIUM OAK, MAHOGANY
PRODUCT WEIGHT: 14LBS.
OVERALL DIMENSIONS: 20"WX18.25"DX30-44"H

- Practical Speaker Stand Lectern
- Features 16"X20" Reading Surface
- Adjustable Height From 30"-44"
- Features Protective T-Mold Edging
- Includes Paper/Book Stop
- Features A 16-Gauge Steel Frame

NPS Product Specifications

600 ARISTOCRAT NON-SOUND LECTERN

COLORS: MAHOGANY, MEDIUM OAK, WILD CHERRY
PRODUCT WEIGHT: 92LBS.
OVERALL DIMENSIONS: 25"WX20"D X 46"H

- Features 2 Built-In Shelves
- Features 1 Slide-Out Shelf
- Slide Out Shelf Wt. Capacity: 35 Lbs.
- High Pressure Thermal-Fused Laminate On A Mdf Core
- Durable Scratch Resistant Surface
- Attractive T-Mold Edging
- Equipped With Four Roll Casters, Two Locking
- Assembly Required

611 VISION LECTERN

COLORS: RIBBONWOOD
PRODUCT WEIGHT: 68LBS.
READING SURFACE DIMENSIONS: 16.25"WX23.6"D
OVERALL DIMENSIONS: 24"WX21"D X 46"H

- Equipped with Two Shelves
- High Pressure Thermal-Fused Laminate on a MDF Core
- Durable Scratch Resistant Surface
- Equipped With Four Concealed Casters, Two Locking
- Assembly Required

612 VISION LECTERN W/ SCREEN

COLORS: RIBBONWOOD
PRODUCT WEIGHT: 70LBS.
READING SURFACE DIMENSIONS: 16.25"WX23.6"D
OVERALL DIMENSIONS: 24"WX21"D X 46"H

- Perfect for Customizing Logos for Institutions and Presentations
- Equipped with a 15" LCD Screen Built into the Front of the Unit
- Display Images Uploaded with a SD-Card or Flash Drive
- Includes a Remote Control
- High Pressure Thermal-Fused Laminate on a MDF Core
- Durable Scratch Resistant Surface
- Equipped With Four Concealed Casters, Two Locking

ZED LECTERN

COLOR: BLACK
PRODUCT WEIGHT: 47.6 LBS.
PRODUCT DIMENSIONS: 19.5"W X 19.5"D X 46.5"H

- Equipped With 40 Watts Multiplayer Amplifier
- Built four 4" 40W speakers
- Includes One gooseneck Mic and One Tie-Clip/Lavaliere Mic
- Input/output Lines for Media Players, Extension Speakers, USB, Bluetooth, Recording & Playing Mp3S
- Equipped with a Halogen Lamp
- Digital Timepiece Included
- High Pressure Thermal-Fused Laminate on A MDF Core
- Durable Scratch Resistance Surface
- Equipped with Four Casters

CHARGING CARTS

DCC DUET CHARGING CART

DIMENSIONS: OVERALL: 281/8"W X 22"D X 38 3/4"H
SURFACE: 22 3/4"W X 21 1/8"D
SHELF: 22 3/4"W X 15 1/2"D

- 2 UL approved power strips with 32 outlet
- Power components are UL and cUL certified
- Adjustable height shelves can be adjusted in 2 1/3" increments
- Fits laptops and tablets with all types of screens up to 15.6" when configured to hold 32 devices
- Maintenance area with four storage shelves for device adaptors
- 18-gauge heavy-duty steel parts
- 4 heavy-duty 4" casters, 2 locking

- 2 point locking system on front and back doors
- One 12ft. power cord to plug into wall
- Hook to wrap the power cord on the side of the cart
- Removable well-ventilated dividers
- Dividers can be positioned at any width in 1 1/8" increments
- Built in wire channels on each divider
- Two-tone modern design
- Dura-flex working surface on top of cart

PRESENTATION CARTS

WIZARD PRESENTATION CART

COLORS: WILD CHERRY, BLACK
PRODUCT WEIGHT: 95LBS.
OVERALL DIMENSIONS: 21"WX18"D X 40"H

- Constructed Of 18-Gauge Steel With Square Tube Corner Support
- Equipped With A Console—Including Both VGA/HDMI Pass-Through Plate
- One Lockable Storage Cabinet
- Features One Sliding Shelf
- Outfitted With A Flip Up Side Shelf On Desk Surface For Additional Space
- A Large Secured Cabinet With Adjustable Shelf
- Equipped With Four 4" Roll Casters
- Mounted In A 25-Foot Cord With A 6-Outlet Power Strip

MMC PRESENTATION CART

COLORS: WILD CHERRY, BLACK
PRODUCT WEIGHT: 93LBS.
OVERALL DIMENSIONS: 25"WX19"D X 38"H

- Features A Front Slide-Out Shelf
- Large Work Surface With Dual Flip-Up Shelves
- One Lockable Storage Cabinet With Adjustable Height Shelf
- One Lockable Draw
- Constructed From High Pressure Thermofused Laminate On Board Core
- Equipped With 3" Casters, Two Locking

PRC200 PRESENTATION CART

COLORS: IVORY WOODGRAIN/BLACK, BLACK
PRODUCT WEIGHT: 36LBS.
OVERALL DIMENSIONS: 18"WX30"D X 40.5"H

- Features 4 Shelves For Audio-Visual Equipment
- Adjustable Shelf From 19" To 39.5" For Sitting Or Standing Position
- Equipped With Wire Management Grommets
- Mounted Six Outlet Power Strip
- Furnished In Black Steel Frame With Ivory Wood Grain Shelves
- Equipped With Four 3" Caster, Two Locking

PRC250 PRESENTATION CART

COLORS: IVORY WOODGRAIN/BLACK, BLACK
PRODUCT WEIGHT: 84LBS.
OVERALL DIMENSIONS: 18"WX30"D X 40.5"H

- Features 4 Shelves For Audio-Visual Equipment
- Adjustable Shelf From 19" To 39.5" For Sitting Or Standing Position
- Features a lockable cabinet with 3 adjustable/removable shelves Equipped With Wire Management Grommets
- Mounted Six Outlet Power Strip
- Furnished In Black Steel Frame With Ivory Wood Grain Shelves
- Equipped With Four 3" Caster, Two Locking

PRC400 PRESENTATION CART

COLORS: IVORY WOODGRAIN/BLACK, BLACK
PRODUCT WEIGHT: 100.5LBS.
OVERALL DIMENSIONS: 21"WX33"D X 40"H

- Features An Extra Large Work Surface And Optional Board
- Outfitted With A Storage Compartment To Safeguard Av Equipment
- 18-Gauge, Black Steel Frame With An Ivory Wood Grain Finish
- Locking Cabinet With An Adjustable Middle Shelf
- Wire Management And Grommets Included
- Equipped With Four 4" Casters, Two Locking

NPS Product Specifications

PRC450 PRESENTATION CART

COLORS: IVORY WOODGRAIN/BLACK, BLACK
PRODUCT WEIGHT: 117.5LBS.
OVERALL DIMENSIONS: 18"W X 30"D X 40.5"H

- Features An Extra Large Work Surface And Optional Board
- Outfitted With A Storage Compartment To Safeguard Av Equipment
- 18-Gauge, Black Steel Frame With An Ivory Wood Grain Finish
- Locking Cabinet With An Adjustable Middle Shelf
- Wire Management And Grommets Included
- A Six-Outlet Power Strip With 20 Ft Cord, And A Cpu Holder Included
- Equipped With Four 4" Casters, Two Locking

BASICS BY NPS

PT3020 / PERSONAL TABLE

- 1.67" thick tabletop.
- NPS Speckled Grey tabletop.
- 20" x 30" tabletop
- Tabletop has a plastic clip to hold the legs in place.
- Powder coated textured grey frames and legs
- Table weight is: 10 lbs
- Table glides are strong and not removable by hand.
- Hex bolt connecting the cross tubes is installed with a nylon insert lock nut and cannot be easily removed.
- Cross brace and tubes are welded nicely.
- Table can be adjusted to 6 different heights:
 - 13-2/3"
 - 18-1/3"
 - 21-2/3"
 - 24-1/4"
 - 26-1/4"
 - 27-7/8"

CL 850 SERIES / COMMERCIALLINE STACK CHAIR

DIMENSIONS: OVERALL: 20"W X 19 1/2"D X 31 3/4"H
SEAT: 17 1/4"W X 17"D X 17"H · BACK: 17 1/4"W X 13 1/2"H

- Polypropylene seat and back
- 18 gauge, 1/2" steel tubing
- Black powdercoated frame
- Ganging glides
- Can stack up to 30 high with our DY-CL85 Dolly
- Chair weight - 8.2 lbs.
- Carton of 4 weight 38.8 lbs. · Carton of 1 weight 13.2 lbs.
- Carton of 4 Dimensions- 23" x 21" x 37" · Carton of 1 Dimensions 22" x 21" x 33"
- Ships from TN
- Freight Class 150
- 250 lbs. weight capacity
- Available Colors: ■ Navy ■ Black

CL 900 SERIES / COMMERCIALLINE ALL-STEEL FOLDING CHAIR

DIMENSIONS: OVERALL: 29 1/4"H X 18"W X 19 1/2"D
FOLDED: 37 3/4"H X 18 1/8"W X 2"D
SEAT: 17 1/4"H X 16"W X 16" D / BACK: 7"H X 17 7/8"W

- Front leg tube: 7/8"x19 gauge
- Rear leg tube: 7/8"x 20 gauge
- Cross bar: 15mm x 21 gauge
- Seat steel plate: 0.8mm
- Back steel plate: 0.6mm
- Chair weight - 8.5 lbs
- Gross weight with box - 36.5 lbs
- 250 lbs. weight capacity
- Available Colors: ■ Beige ■ Grey ■ Black

CL 950 SERIES / COMMERCIALLINE VINYL PADDED FOLDING CHAIR

DIMENSIONS: OVERALL: 29 1/4"H X 18 1/2"W X 19 1/2"D
FOLDED: 37 3/4"H X 18 1/8"W X 2 1/2"D

SEAT: 17 3/4"H X 15 1/2"W X 15 1/2" D / BACK: 7"H X 18"W

- Front leg tube: 7/8"x19 gauge
- Rear leg tube: 7/8"x 20 gauge
- Cross bar: 15mm x 21 gauge
- Seat steel plate: 0.7mm
- Back steel plate: 0.6mm
- Seat fibreboard: 3mm
- Seat/back vinyl: 0.24mm
- Chair weight - 9.75 lbs
- Gross weight with box - 36.5 lbs
- 250 lbs. weight capacity
- Available Colors: ■ Beige/Beige ■ Grey/Grey ■ Black/Black

CL 970 SERIES / COMMERCIALLINE FABRIC PADDED FOLDING CHAIR

DIMENSIONS: OVERALL: 29 1/4"H X 18 1/2"W X 19 1/2"D
FOLDED: 37 3/4"H X 18 1/8"W X 2 1/2"D

SEAT: 17 3/4"H X 15 1/2"W X 15 1/2" D / BACK: 7"H X 18"W

- Front leg tube: 7/8"x19 gauge
- Rear leg tube: 7/8"x 20 gauge
- Cross bar: 15mm x 21 gauge
- Seat steel plate: 0.7mm
- Back steel plate: 0.6mm
- Seat fibreboard: 3mm
- Seat/back vinyl: 0.24mm
- Chair weight - 9.75 lbs
- Gross weight with box - 36.5 lbs
- 250 lbs. weight capacity
- Available Colors: ■ Star Trail Black Fabric / Black Frame, ■ Star Trail Brown Fabric / Beige Frame, ■ Star Trail Blue / Navy Blue Frame

DY-CL85 / DOLLY FOR CL-850 SERIES CHAIRS

DIMENSIONS: OVERALL: 21 3/4"W X 31 1/2"L X 17-1/3"H

- Stacks 30 850-CL chairs.
- Product weight 52 lbs.
- Carton dimensions 22" x 32 1/4" x 18"
- Carton weight 57 lbs.
- Hard Rubber Locking Casters 3" x 1 1/4"

Protecting the environment is one of the most important factors affecting the future of the planet. Most people are now aware of the necessity of preserving and protecting nature in order to ensure our well-being and that of our children. Pollution, especially that related to the over-consumption of raw materials, has reached alarming levels due to our current lifestyle. That is why at National Public Seating® we are constantly striving to minimize the consequences of our activities.

At National Public Seating®, the quality of our products and the protection of the environment go hand in hand. As a consumer of raw material, we are committed to the use of pre and post consumer waste (recycled material), while preserving the high quality standards of our products.



ENVIRONMENTAL STATEMENT

EXAMPLES OF THIS INCLUDE:

- **STEEL** - All of the steel for our products contain 30-40% of post-consumer waste (recycled).
- **CORRUGATED CONTAINERS** - Are made of recycled fiber. 100% total recycled content and 90% post consumer content minimum.
- **PLASTIC** - Our plastic products contain up to 35% of pre-consumer waste.
- **WOOD** - 100% of wood used for our products comes from non-boreal forests.
- **POWDER COATING VS. LIQUID FINISHES** - Our products are powder coated and are highly protective to our environment. While liquid finishes contain solvents which have pollutants known as volatile organic compounds (VOCs), powder coating contains no solvents and releases negligible amounts, if any, of VOCs into the atmosphere. In addition, most powder coating overspray that does not adhere to the part is retrieved and reused, virtually eliminating the waste commonly found in liquid finishing processes.
- **ENERGY** - During November 2008, National Public Seating®, completed a retrofit of all its lighting (over 800 fixtures), to eco-friendly units, saving 135,586 kWh annually. This reduction in energy consumption has an environmental impact equivalent to removing 20 cars from the road, 84 tons of greenhouse gas (CO2) and saving 198 barrels of oil annually!
- **AIR EMISSIONS** - Our Folding Chairs are manufactured within ANSI BIFMA X7.1 2007 VOC Air Emission guidelines; Criteria #1 - TVOC, Formaldehyde, All Aldehydes & 4-Phenylcyclohexene.
- **MAS CERTIFIED GREEN** - The entire NPS® Product Line is now MAS Certified Green™, a nationally recognized registered trademark delineating low VOC emitting products in the marketplace so that purchasers and specifiers of those products know that they can earn credits in sustainability programs like LEED, BIFMA's Level, and California CHP program.
- **SOLAR ENERGY** - As the industry leader in institutional-grade furniture, including portable folding furniture for lunch rooms, training rooms, etc., & furniture for worship halls, science labs, music programs, performing arts, cafeterias & others, NPS® continues to trailblaze in setting the standard for environmental stewardship. In addition to minimizing its eco footprint in the areas of raw material sourcing, energy consumption & air emissions, NPS® is proud to announce a major solar panel installation on the roof of its 200,000 square foot factory facility in its corporate headquarters in Clifton, NJ, completed Summer 2011. Via the installation of a 240KW solar PV system on its roof, we will offset most of the local utility's need to burn oil and gas for electrical production in the public grid and therefore reduce greenhouse gas emissions into the atmosphere. Since we will be generating 80% of the electricity that we use with this system, we have cut our carbon footprint significantly.



WARRANTY INFORMATION

National Public Seating® offers the original user a warranty against all manufacturing defects in material and workmanship from date of purchase for ten years*. If defective, NPS will, at its option, repair or replace the defective product. This warranty does not apply to damage resulting from misuse, abuse or neglect. Excessive swaying back and forth on any banquet stack chair will entirely void the warranty. Authorization for return and / or repairs is required by contacting your dealer. This warranty gives you specific rights, and you may also have other rights which vary by state.

Orders are accepted under the express agreement that under no circumstances will seller be liable for any incidental or consequential damages, or for any other loss,

damage or expense of any kind, including loss of profits, arising in connection with the order or with the use or inability to use seller's products furnished under the order. Seller's maximum liability shall not exceed and buyer's remedy is limited to either (i) repair or replacement of the defective part or product, or at seller's option (ii) return of the product and refund of the purchase price. Such remedy shall be the buyer's entire and exclusive remedy.

*Fifteen years for Mobile Cafeteria Tables,

*One year for Basics By NPS and Butcherblock



ADDRESS 149 Entin Road | Clifton, New Jersey 07014
TEL 800.261.4112 | **FAX** 973.594.9339
www.nationalpublicseating.com



**National
Public
Seating**



149 Entin Road | Clifton, NJ 07014
Tel 800.261.4112 | Fax 973.594.9339
www.nationalpublicseating.com