

PRODUCTS PICTURED:
LINEAR REFRESH CHAIR

TEXTILES PICTURED:
VARSITY
LINETTE



2024 FULL LINE CATALOG

AT OUR CORE

WE ARE COMMITTED TO

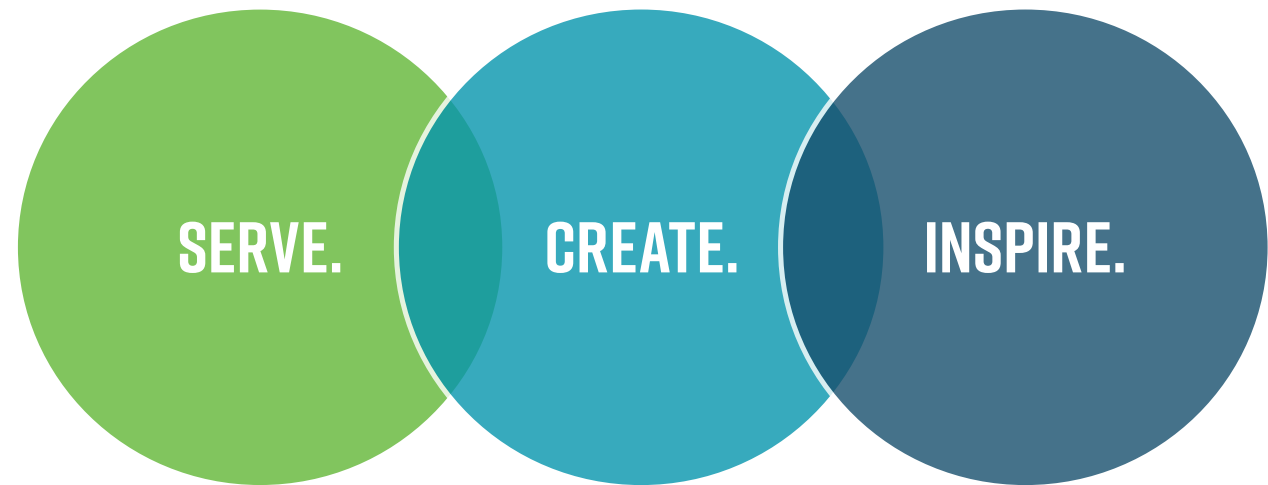

AND OUR MISSION IS TO **BLESS OTHERS**



WE SERVE OUR PEOPLE AND CUSTOMERS BY INSPIRING HEALTHY, SAFE, AND ADAPTABLE ENVIRONMENTS THAT CREATE SPACE FOR EVERYONE TO **CONNECT AND BELONG.**

Soft seating is all we do, and foam is all we do it with. It's what makes us the foam experts! Our expertise in foam is unmatched, and we take pride in our unique single-cut foam construction that not only makes our furniture more sustainable and cost-effective but also ensures its durability under high usage. With hundreds of color options in fabrics and vinyl, as well as other finishing options, you can be sure our furniture will fit your unique needs. No other company creates quality, stylish, comfortable soft seating backed by a lifetime warranty* like we do at Fōmcore. Give us a chance to prove ourselves and experience the transformation Fōmcore soft seating can bring to your space.



*See page 65 for lifetime warranty details.

CONTENTS

AT OUR CORE	1 - 2
IT'S ALL IN THE DETAILS	3 - 4
OTTOMAN & BENCH SERIES	5 - 6
ARMLESS SERIES	7 - 8
CONNECT SERIES	9 - 10
CAFÉ SERIES	11
SOCIAL SERIES	12
NEST SERIES	13 - 14
STEP SERIES	15
NETWORK SERIES	16
LOTUS SERIES	17 - 18
WEATHER RESISTANT SERIES	19 - 20
CREATE YOUR COMBO	21 - 22
FŌM FILLED SERIES	23
MATERIAL SWATCHES	24 - 26
MODIFICATIONS	27 - 28
DESIGN SERVICES	29 - 30
AT A GLANCE	31 - 32
WHY FOAM?	33 - 34
PRODUCT REFERENCE GUIDE	35 - 61
POWER REFERENCE GUIDE	63 - 64
CUSTOMER SERVICE	65 - 66

2024 NEW PRODUCT



PRODUCTS PICTURED:
LILY PAD
TEXTILES PICTURED:
MICRO DOT

LEARN MORE ABOUT WHO WE ARE AND OUR CORE VALUES #ATOURCORE



SCAN or CLICK ME

IT'S ALL IN THE DETAILS

SO MUCH MORE THAN JUST AN OTTOMAN

CUSTOMIZATION VS. MODIFICATION

CUSTOMIZATION

- Work with our design and engineering team to create a completely custom design
- Create or design any shape, even abstract (ex. dolphin, airplane, star, etc.)
- Typically, there is no extended lead time for custom orders once the drawings have been approved

MODIFICATION

- Modify any of our standard pieces by altering the height or width
**In many cases there is no additional charge to make this change.*
- Other modifications available:
 - Thread/zipper color
 - Glides, legs, casters
 - Power options
 - TFL work surface
 - Embroidery
 - Weather resistant
 - Textile option and placement



CUSTOM PIECE



MODIFIED PIECE

CONSTRUCTION

- Solid foam construction means there is no internal wood frame
- Foam fabrication is done in-house with 600lb buns of foam
- Each product is sewn with double seams to ensure the strength and integrity
- Marine grade nylon thread is not only strong, but it also holds up to both light and moisture
- The rounded edge on our wood base protects the textile from cracking or ripping
- With each shipment, you receive a custom-made Klever Kutter to cut open packaging - not your product
- Machines are not creating our product - people are! We have a robust training program to ensure each team member is a true craftsman in their department
- All promoted textiles are tested and approved for use
- Engineers are in-house and hands-on; they develop and test products to make sure they meet BIFMA standards
- Our precision cutting equipment allows for endless shapes, sizes, and customization
- We stand behind our products with a lifetime warranty* See page 65 for details



TEXTILES PICTURED:
SILICA JIG
CRISSCROSS



WHERE OUR PRODUCTS FIT

- **K-12**
 - Classroom
 - Playground
 - Cafeteria
 - Library
 - Computer Lab
 - Administration
 - Spaces in Between
- **HEALTHCARE**
 - Reception
 - Waiting Room
 - Pediatric
 - Café
 - Consultation Space
 - Self Care
 - Spaces in Between
- **HIGHER EDUCATION**
 - Library
 - Residence Hall
 - Dorm Room
 - Dining Hall
 - Administration
 - Lecture Hall
 - Student Union
 - Computer Lab
 - Career Services
 - Communal Study Spaces
 - Spaces in Between
- **COMMERCIAL**
 - Office
 - Breakroom
 - Lounge
 - Work Space
 - Collaborative Space
 - Conference Room
 - Lobby
 - Outdoor Space
 - Café
 - Spaces in Between

ZIPPERED VS. UPHOLSTERED

ZIPPERED

- Solid foam construction
- No wood base
- No pinch points
- Zipper sealed from the inside, so fabric won't come undone
- Can be utilized in multiple ways

UPHOLSTERED

- Solid foam construction
- Upholstered to wood base with rounded edges to protect textile
- High-quality black fabric with black staples to cover the bottom
- Allows for the modification of legs, glides, casters, and power

ZIPPERED



UPHOLSTERED



PRODUCTS PICTURED:
BUMP BENCH
ANDERSON CHAIR
LILY PAD

TEXTILES PICTURED:
BAYSIDE
LARA

CHECK OUT OUR
BE INSPIRED PAGE
TO SEE MORE



SCAN or CLICK ME

OTTOMAN & BENCH SERIES

The Ottoman and Bench Series takes flexible seating to the next level. With a lightweight, solid foam structure, it's easy to create exactly what you need. Whether you are looking to create a personal space or collaborative environment, you can do it quickly and efficiently with pieces from the Ottoman and Bench Series.



TEXTILES PICTURED:
EVO
SIVERTEX

OTTOMANS

- 18" ROUND OTTOMAN F005-18
- 30" ROUND OTTOMAN F005-30
- 36" ROUND OTTOMAN F005-36
- RECTANGLE OTTOMAN F001
- ROK DROP F166 (NEW DESIGN)
- CRESCENT OTTOMAN F003
- HONEYCOMB OTTOMAN F004
- PENTAGON OTTOMAN F007
- SPIN WEDGE OTTOMAN F055
- PETAL OTTOMAN F101

ROK Drop is fully foam, has a non-slip base, and comes in 2 heights.

IDEA STARTERS

- PRODUCTS: F013
- PRODUCTS: F101, F005-30
- PRODUCTS: F004
- PRODUCTS: F005, F008
- PRODUCTS: F001 (with TFL)
- PRODUCTS: F077, F005
- PRODUCTS: F003, F005-22

BENCHES

- AMOeba BENCH F006
- BUMP BENCH F008
- BENCH 48 F009
- WEDGE BENCH F010
- ¼ ROUND BENCH F011 (90° Angle)
- ½ ROUND BENCH F013
- ARC BENCH 60 F015 (60° Angle)
- BOWTIE BENCH F077
- ROLLING HILLS F127

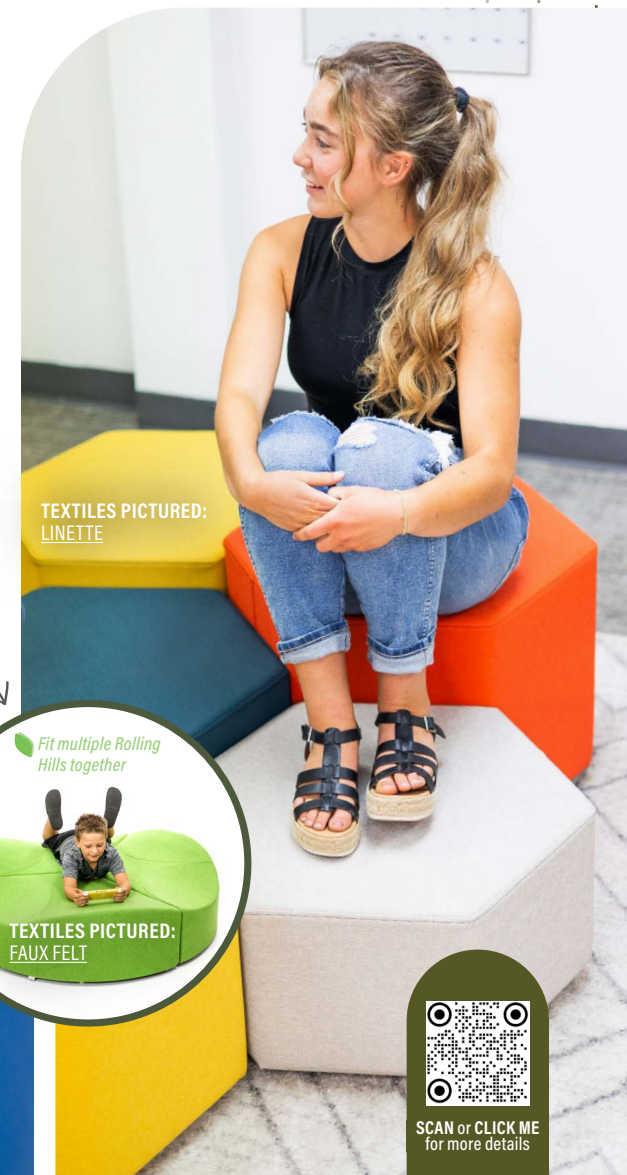

TEXTILES PICTURED:
LINETTE

Fit multiple Rolling Hills together

TEXTILES PICTURED:
FAUX FELT

See the Fomcore craftsmanship up close. Our standard practice is to match the thread to the seat color of the furniture, however you can choose a different thread at no extra charge.

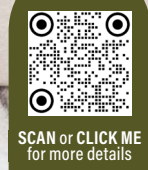

SCAN or CLICK ME for more details

ARMLESS SERIES

Cultivate creativity and engage the senses with endless possibilities of combinations utilizing all the pieces in the Armless Series. With a waterfall edge and lightweight structure, mix and match multiple pieces to form serpentine, circles, sectional seating, or any other design you can imagine as you create the perfect environment.



TEXTILES PICTURED:
VARSITY
LINETTE
BIG DOT



TEXTILES PICTURED:
TRIVIA
SIVERTEX

ARMLESS SERIES

IDEA STARTERS

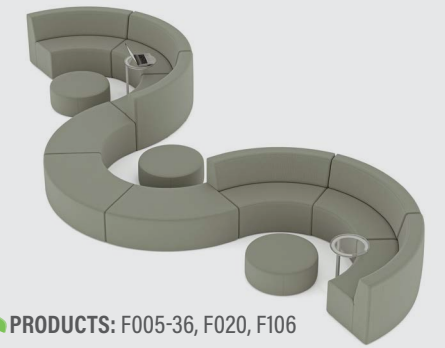

PRODUCTS: F005-36, F020, F106



PRODUCTS: F005-30 (with TFL), F019, F061, F016, F062

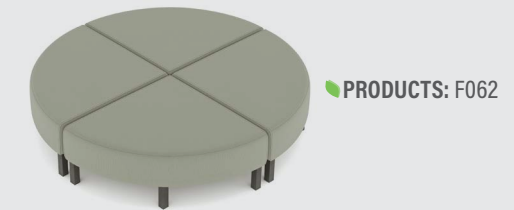

PRODUCTS: F062



PRODUCTS: F139, F141, F001 (with TFL)

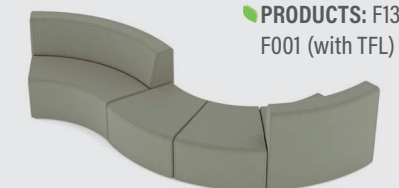

PRODUCTS: F020, F108, F018



SCAN or CLICK ME for more details

CURVED ARMLESS

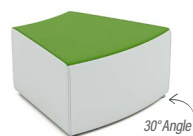

CURVED BENCH 30
F108

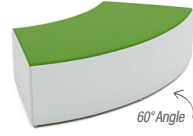

CURVED BENCH 60
F106



CURVED LOVESEAT
F018



CURVED SOFA IN
F020



CURVED OUTSIDE SOFA 40
F109



ARMLESS CURVED CORNER
F061



TEXTILES PICTURED:
BANDWIDTH
EVO

LINEAR REFRESH



LINEAR REFRESH CHAIR
F139



LINEAR REFRESH LOVESEAT
F140



LINEAR REFRESH SOFA
F141



LINEAR REFRESH OTTOMAN
F142



LINEAR REFRESH BENCH
F143

LINEAR ARMLESS



LINEAR CORNER
F024



LINEAR LOVESEAT
F017



LINEAR SOFA
F019



LINEAR CHAIR
F016



LINEAR WEDGE
F062



LINEAR OTTOMAN
F107



TEXTILES PICTURED:
LARA
PING PONG

FOR PRODUCT DETAILS SEE PAGES 39-43

TEXTILES PICTURED:
VARSITY
LINETTE



IDEA STARTERS

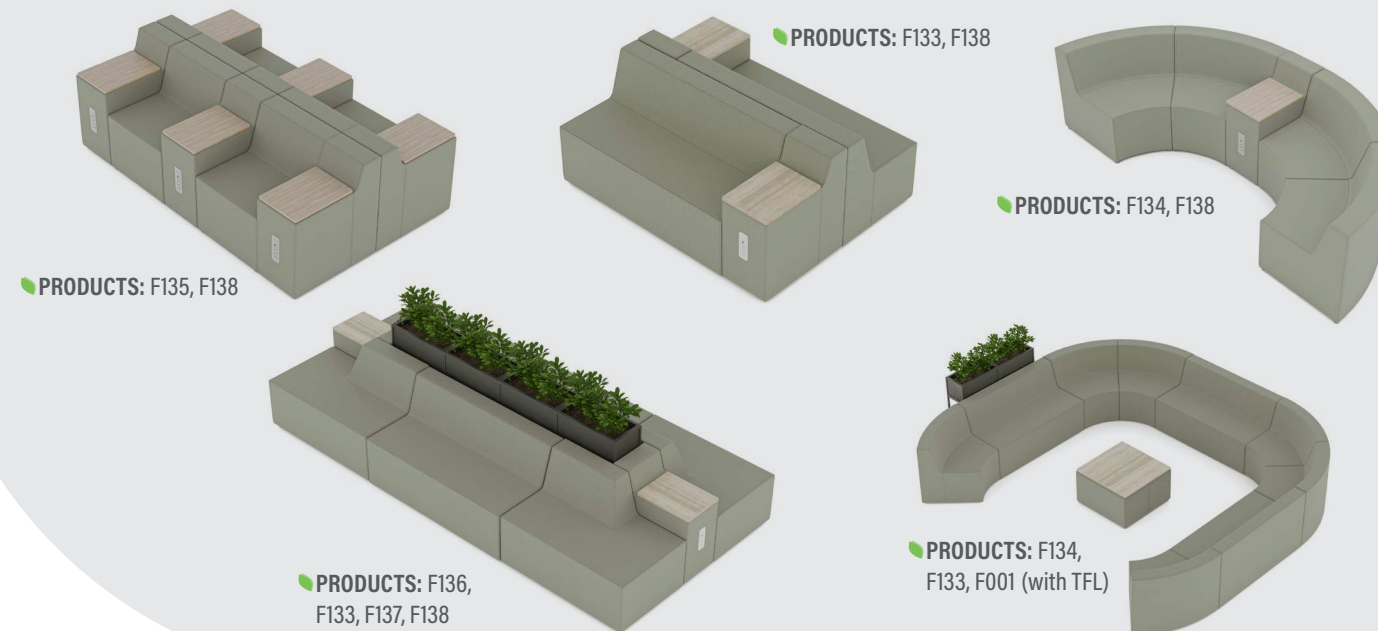

PRODUCTS: F133, F138

PRODUCTS: F135, F138

PRODUCTS: F134, F138

PRODUCTS: F136, F133, F137, F138

PRODUCTS: F134, F133, F001 (with TFL)

CONNECT SERIES

Create. Collaborate. Connect. The Connect Series inspires creativity and collaboration in a variety of environments. Whether you're looking for flexible seating to add to a conference room or a classroom, this set can be arranged to make countless formations. With our lightweight, solid foam construction, the Connect Series can be easily maneuvered to create a collaborative space for any environment.



CONNECT LOW BACK SOFA
F133



CONNECT LOW BACK CURVED CHAIR
F134

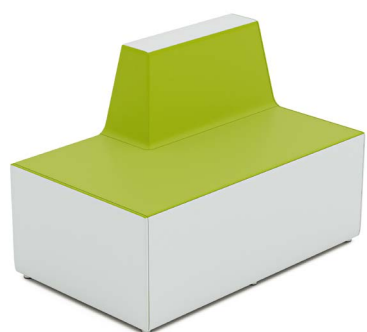

CONNECT LOW BACK SOFA RIGHT HAND
F136



CONNECT LOW BACK SOFA LEFT HAND
F137



CONNECT LOW BACK CHAIR
F135



CONNECT LOW BACK TABLE
F138



TEXTILES PICTURED:
LARA
ALPHABET
POLYGON



TEXTILES PICTURED:
LARA
SIVERTEX
SATCHEL

FOR PRODUCT DETAILS SEE PAGES 43-44





TEXTILES PICTURED:
SIVERTEX

IDEA STARTERS

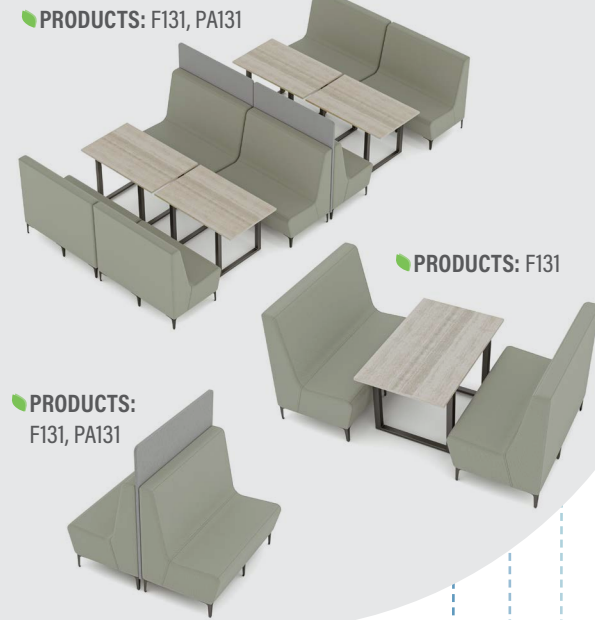

CAFÉ SERIES

Use the Café Series to create community spaces in libraries, informal locations, and of course, dining centers. Energize these spaces with booth installations that help with connection and encourage the development of social and academic relationships essential for success.

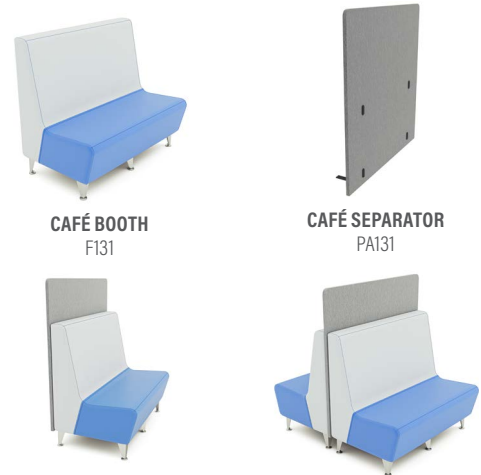

TEXTILES PICTURED:
EVO
JACKPOT

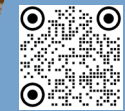

SCAN or CLICK ME for more details

SOCIAL SERIES

Comfortable, functional, and creative are the keystones to the Social Series. Solid foam construction and lightweight design allow for each piece to be arranged easily to suit any environment. Each piece is meticulously designed to meet the demands of form and function.

IDEA STARTERS

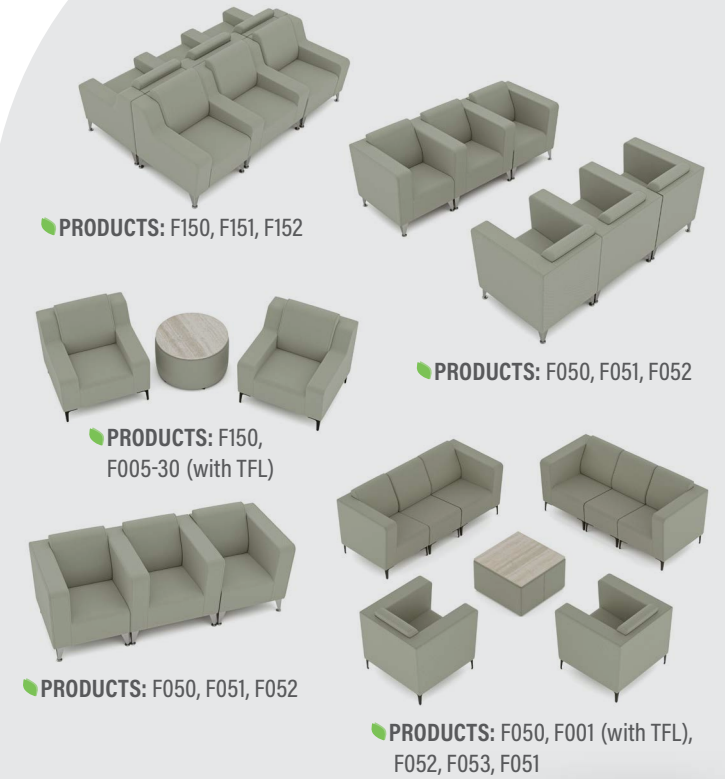

TEXTILES PICTURED:
SILVERTEX



TEXTILES PICTURED:
SILICA

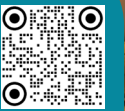

SCAN or CLICK ME for more details

NEST SERIES

Our patented Nest Series is where mindfulness and reflection meet. The perfect spot for a little alone time and reflection. The fully zippered and solid foam construction allow for lightweight and easy movement. The Nest Series is a comfortable and safe area to curl up to sit and read or flip on its side to engage with others as a collaborative space.

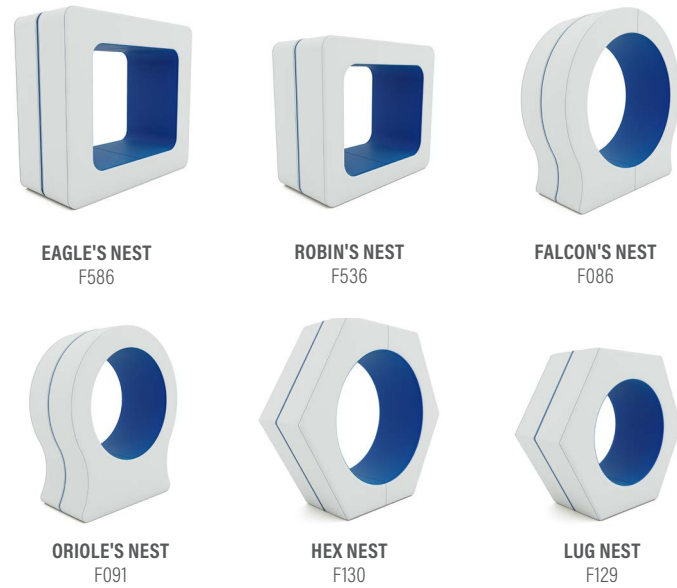

Our patented design!



*Fit multiple Pads inside a Nest
Nest and Pads are sold separately*

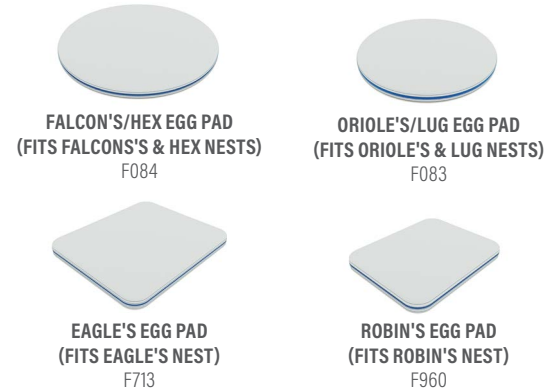

Available in Chelsea Maple and Gull Grey

Inspiration can be found in numerous ways and from countless sources. One can find inspiration in a conversation with a friend, a song that pops up on our playlist, or from a walk outside. The students at Desert Hot Springs HS in Desert Hot Springs, California, particularly inspired us. Together with one of our dealer partners, we collaborated with a Career Tech class of Juniors at DHSHS for our first-ever "For Students by Students" project. We had a simple premise: Connect with students and staff at a local school and craft a tailor-made curriculum, allowing students to design a unique piece of furniture that serves a purpose in their classroom. We were amazed by the students' creations! Under the guidance of their Career Tech teacher, Stacy Ward, the students had to come up with "mindful" designs of furniture that would help students relax and realign. For three months, students worked in teams, thinking about the construction and design elements, along with engaging in philosophical conversations about how space affects our emotions, and the purpose furniture should serve in such spaces.

At the end of three months, students presented their ideas and, in the end, landed on the "NEST", a versatile piece that lets students either interact with a group or have a moment of quiet. The students received a NEST for their school, a \$1,000 grant, and they were given the opportunity to learn and discover with a real-world application.



STUDENTS FROM DESERT HOT SPRINGS HIGH SCHOOL



TEXTILES PICTURED: BEGUILLED BY THE WILD, SILVERTEX



STEP SERIES

The finely crafted Step Series is built to impress and function in any environment. Solid foam construction means there are no hard edges, and they are light and convenient to move. The perfect solution for creating useful, collaborative seating in even the most unlikely spaces, turning hallways and corridors into collabor-idors! The entire line from the Step Series can be fit together to create countless arrangements.

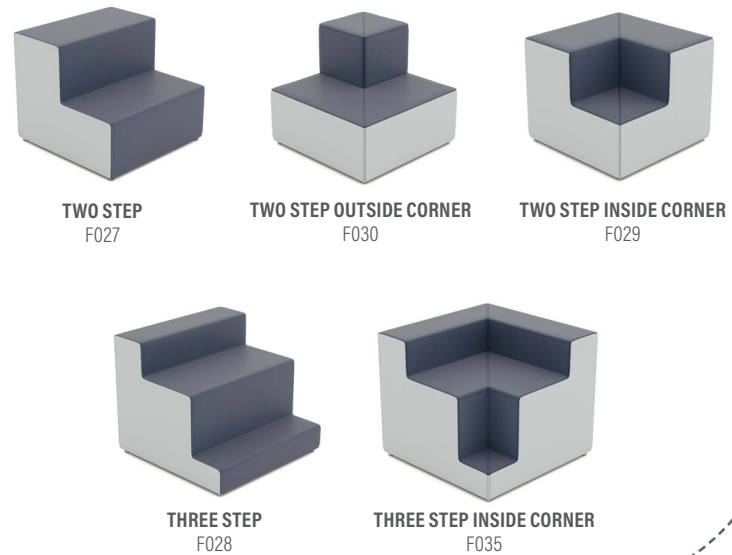

IDEA STARTERS

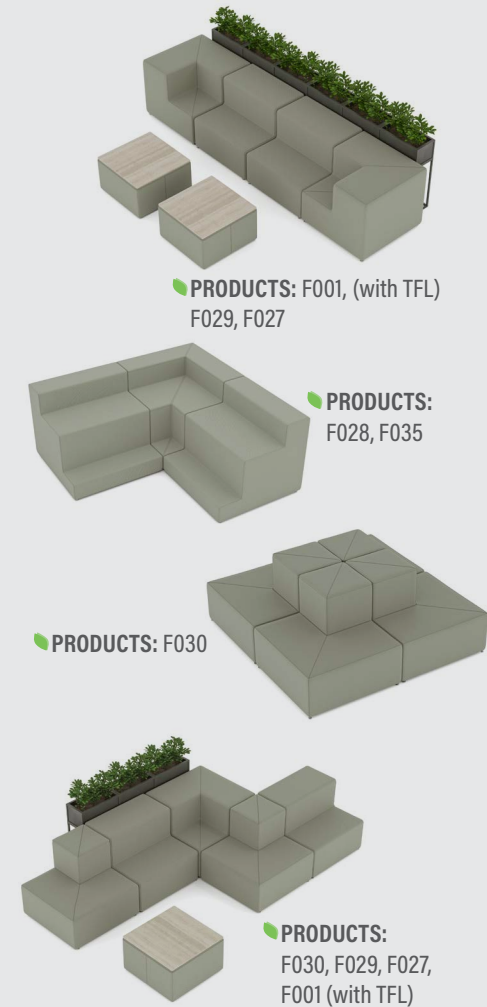

NETWORK SERIES

With our lightweight, solid foam construction, you can maneuver the Network Series into endless combinations. Meetings, gatherings, and even quick chats will flourish in your purposefully curated spaces. Showcasing the variety of geometry from the Network Series, your creativity has no bounds to craft the proper environment for any situation.

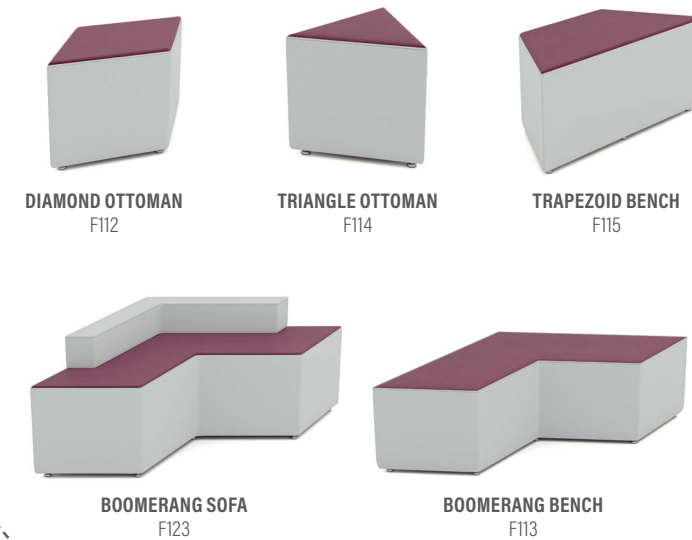

IDEA STARTERS

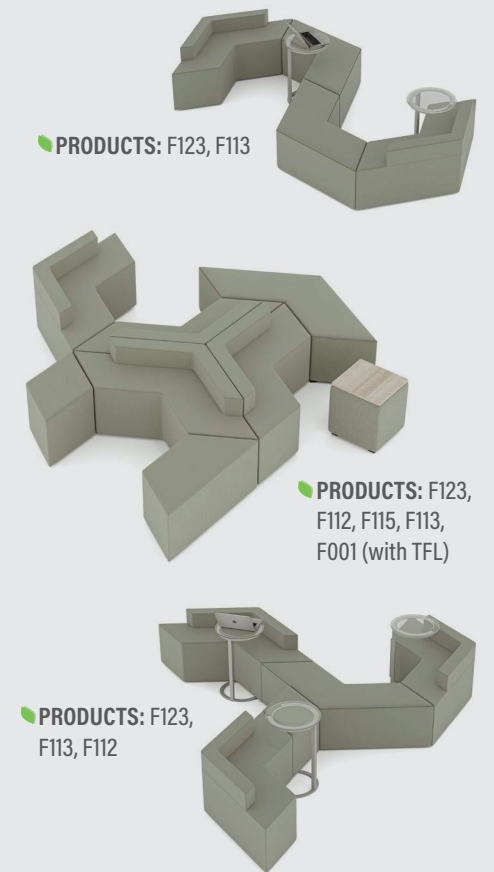

TEXTILES PICTURED:
CHAMBRAY
SILVERTEX

TEXTILES PICTURED:
NATURAL LINEN
MAGLIA
SILVERTEX



SCAN or CLICK ME for more details

TEXTILES PICTURED:
SILICA
SILICA LEATHER
SILICONE DOWNTOWN
MIRCOSUEDE

FOR PRODUCT DETAILS SEE PAGE 48



SCAN or CLICK ME for more details

FOR PRODUCT DETAILS SEE PAGE 49

LOTUS SERIES

Change your angle — change your perspective. This fun and functional series is meant to give learners of all ages a comfortable seating option closer to the floor. All of the pieces in the Lotus Series are crafted without a wood base and come fully zippered. Keeping it comfy, whimsical, and giving space for creative energy. Give yourself a new perspective with the Lotus Series.

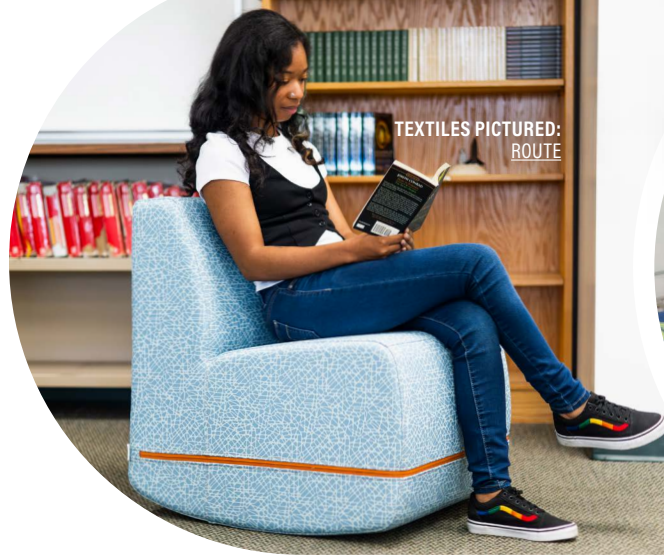

TEXTILES PICTURED:
ROUTE



TEXTILES PICTURED:
SIVERTEX



TEXTILES PICTURED:
SIVERTEX

FOR PRODUCT DETAILS SEE PAGES 50-54

LOTUS SERIES

Many products available in multiple sizes. See pages 50-52 for details.

6" Lily Pads are available.

Pair any Lil Explorers pieces with Lily Pads for even more fun!

Organize your space and make it fun by combining Lily Pads and a Lily Cart.

NEW DESIGN

NEW

ROCK'N ROLLER
F165

ANDERSON CHAIR
FK005

FLOP
FK006

LILY PAD
FK007

LOG OTTOMAN
FK501

HALF DOME
FK031

MEDIA CHAIR
F122

ZERO GRAVITY CHAIR
F121

LILY CART
(FITS 10 - 3" LILY PADS)
FK007-CART2

SENSORY & SAFE

Hug Chair 2.0 available in Junior and XL sizes

NEW DESIGN

NEW

HUG CHAIR 2.0
FK034

HUG CHAIR
F721

FÔM DIVIDER
FK028

FÔM CHAIR
FK020

FÔM DESK
FK033

TEXTILES PICTURED: SIVERTEX



TEXTILES PICTURED:
SIVERTEX



TEXTILES PICTURED:
SIVERTEX

NEW LIL EXPLORERS

Designed to support play-based learning for young children.

Combos available using Lil Explorers pieces. See page 21 for details.

Square available in 3 sizes.

BRICK
FK061

ARCH
FK062

CURVED RAMP
FK063

STRAIGHT RAMP
FK064

SLAB
FK065

RECTANGLE
FK066

STEP
FK067

SQUARE
FK068

L-STEP
FK069

CYLINDER
FK070

BUBBA BELUGA
F170

DUNCAN DUCK
F171

ROXY T-REX
F172

BO BRACHO
F173

TURBO TRIKE
F174

HUGO HORSE
F175

NEW ROCK'N IN THE WILD



TEXTILES PICTURED:
SIVERTEX



SCAN or CLICK ME for more details



TEXTILES PICTURED:
BAYSIDE



TEXTILES PICTURED:
BAYSIDE

WEATHER RESISTANT SERIES

TEXTILES PICTURED:
BAYSIDE

MARINE GRADE
NYLON THREAD

SOLID FOAM
CONSTRUCTION

VINYL WITH UV &
FADE RESISTANT
PROTECTION
(AVAILABLE IN 28 COLORS!)

MADE IN THE USA

QUICK DRY
OUTDOOR FOAM

EXTERIOR
WOOD BASE

LOW PROFILE LEGS
*INCREASES SCRATCH
RESISTANCE*

New **WEATHER RESISTANT
SERIES**

Soft, durable, quick drying, lightweight, and weather resistant is what you can expect from Fōmcore's new outdoor-friendly furniture. Produced using marine grade nylon thread and Bayside vinyl with UV and fade resistant protection, you can enjoy the same Fōmcore quality and craftsmanship backed with a 3-year warranty.*



1" LOW PROFILE
BLACK LEG (L1)



RECTANGLE OTTOMAN
FW001



CRESCENT OTTOMAN
FW003



HONEYCOMB OTTOMAN
FW004



SPIN WEDGE OTTOMAN
FW055



PETAL OTTOMAN
FW101



18" ROUND OTTOMAN
FW005-18



30" ROUND OTTOMAN
FW005-30



36" ROUND OTTOMAN
FW005-36



BENCH 48
FW009

*See page 65 for 3-year warranty details.



TEXTILES PICTURED:
BAYSIDE

**EASILY TRANSITION FURNITURE
FROM INDOOR TO OUTDOOR.**



SCAN or CLICK ME
for more details

CREATE YOUR COMBO

Add fun and creative group learning areas to any room by creating your own combo! Place one of these combos in a room and watch learners of all ages naturally migrate towards the comfortable and inviting seating. Combos are also a mindful solution for breakout spaces.

See product availability for adult & junior sizes on pages 57-60.

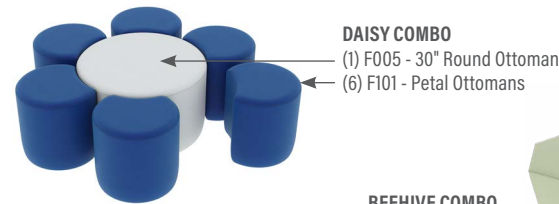

DAISY COMBO
(1) F005 - 30" Round Ottoman
(6) F101 - Petal Ottomans



BEEHIVE COMBO
(7) F004 - Honeycomb Ottomans



SPIN COMBO
(5) F055 - Spin Wedge Ottomans
(6) F055 - Spin Wedge Ottomans

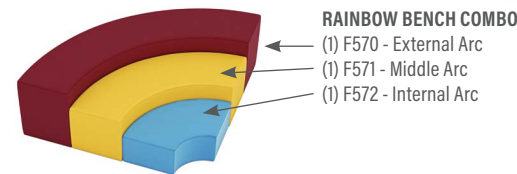

RAINBOW BENCH COMBO
(1) F570 - External Arc
(1) F571 - Middle Arc
(1) F572 - Internal Arc

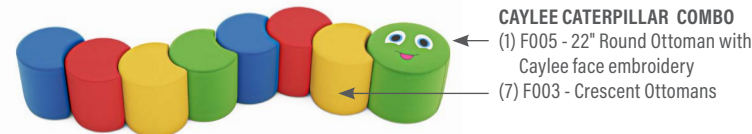

CAYLEE CATERPILLAR COMBO
(1) F005 - 22" Round Ottoman with Caylee face embroidery
(7) F003 - Crescent Ottomans

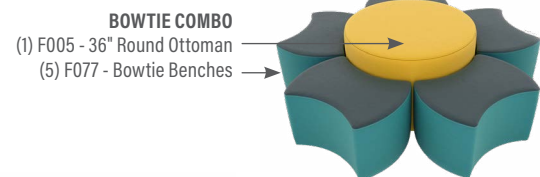

BOWTIE COMBO
(1) F005 - 36" Round Ottoman
(5) F077 - Bowtie Benches

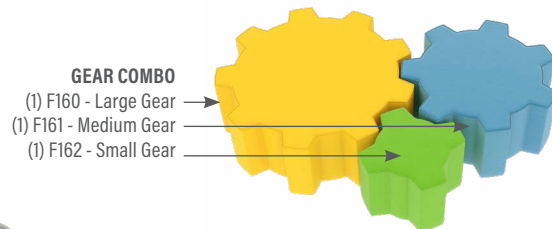

GEAR COMBO
(1) F160 - Large Gear
(1) F161 - Medium Gear
(1) F162 - Small Gear

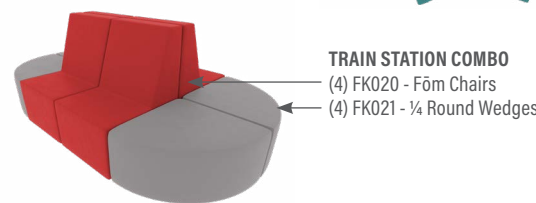

TRAIN STATION COMBO
(4) FK020 - Fom Chairs
(4) FK021 - 1/4 Round Wedges



CONVO LILY PAD AND CART COMBO
(10) FK007 - 3" Lily Pads
(1) FK007-CART2 - Lily Cart

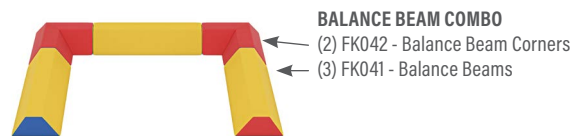

BALANCE BEAM COMBO
(2) FK042 - Balance Beam Corners
(3) FK041 - Balance Beams

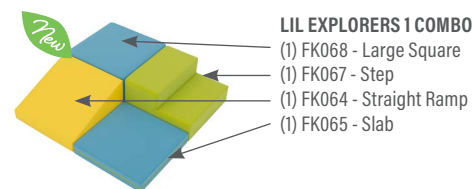

LIL EXPLORERS 1 COMBO
(1) FK068 - Large Square
(1) FK067 - Step
(1) FK064 - Straight Ramp
(1) FK065 - Slab

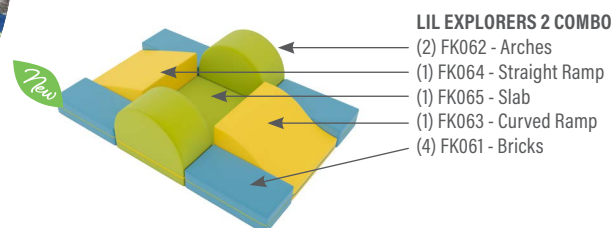

LIL EXPLORERS 2 COMBO
(2) FK062 - Arches
(1) FK064 - Straight Ramp
(1) FK065 - Slab
(1) FK063 - Curved Ramp
(4) FK061 - Bricks



TEXTILES PICTURED:
SIVERTEX



TEXTILES PICTURED:
SIVERTEX
BANDWIDTH

CREATE YOUR COMBO

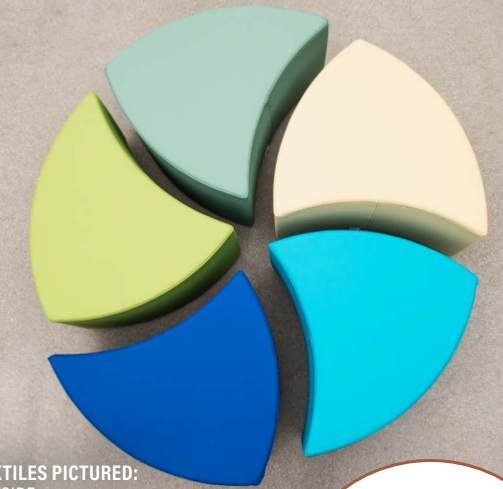

TEXTILES PICTURED:
BAYSIDE

CAMPFIRE COMBO

EDUCATIONAL STORY

The new Campfire Combo is a perfect arrangement for students to gather for group time and shared learning. By design, the Campfire Combo draws students in; gathering them around a shared "Foam Flame" focal point. With 3 different colors of foam triangles, the Foam Flame serves as an interactive instructional tool for facilitating a group. Teachers can quickly split students up to gather around one of the 3 flames for group break outs (ex: "Red Flames, let's gather on this side of the campfire; Yellow Flames, over on the other side").

Other possibilities include the flexibility it gives teachers in providing directives based on what color flame a student is holding (ex: "When the Orange Flame is passed to you, share a time something made you laugh. When you receive the Yellow Flame, turn to the person next to you and give them a compliment"). Further, the Log Ottomans are constructed of solid foam making them lightweight and durable, perfect for students to rearrange yet strong enough for the demands of the classroom.

Log Ottomans are displaying our custom Tree Bark & Rings textile.



(4) FK501 - 48" Log Ottomans
(6) FK501 - 16" Log Ottomans
(1) F005 - 30" Round Ottoman
(3) FK032 - Triangle Flame



TEXTILES PICTURED:
SIVERTEX
TREE BARK AND RINGS



SCAN or CLICK ME
for more details

FÔM FILLED SERIES

Our Fôm Bean Bags and Loungers are meant to replace the traditional bean bags. Not only are they easy to clean and comfortable, they are what bean bag style chairs should be. Sturdy yet flexible and comfy for hours on end. Each one is made by a master craftsman and built to last.



FÔM BEAN BAG
FF003 (3' BAG)
FF004 (4' BAG)



FÔM LOUNGER
FF017 (5' LOUNGER)
FF012 (6' LOUNGER)
FF013 (7' LOUNGER)

TEXTILES PICTURED:
MIRCOSUEDE



5' FÔM LOUNGER



TEXTILES PICTURED:
MIRCOSUEDE

7' FÔM LOUNGER



3' FÔM BEAN BAG

TEXTILES PICTURED:
MIRCOSUEDE



TEXTILES PICTURED:
MIRCOSUEDE

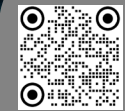

SCAN or CLICK ME for more details

FOR PRODUCT DETAILS SEE PAGE 61

FÔM FILLED MIRCOSUEDE

- MIRCOSUEDE NAVY-112
- MIRCOSUEDE RED-113
- MIRCOSUEDE PURPLE-114
- MIRCOSUEDE LIGHT GREEN-115
- MIRCOSUEDE LIGHT BLUE-116
- MIRCOSUEDE BLACK-117
- MIRCOSUEDE BROWN-118
- MIRCOSUEDE DARK GREY-119



MATERIAL SWATCHES

SILVERTEX NEO

GRADE ONE - VINYL

BY SPRADLING | VINYL, PERMABLOK TOPCOAT | ABRASION 100,000

- SILVERTEX NEO MARINE BLUE
- SILVERTEX NEO LAGOON
- SILVERTEX NEO TURQUOISE
- SILVERTEX NEO PLATA
- SILVERTEX NEO STORM
- SILVERTEX NEO SAPPHIRE
- SILVERTEX NEO JET
- SILVERTEX NEO STERLING
- SILVERTEX NEO NEUTRA
- SILVERTEX NEO METEOR
- SILVERTEX NEO CARBON
- SILVERTEX NEO CREME DE MENTHE
- SILVERTEX NEO ACID
- SILVERTEX NEO BASIL
- SILVERTEX NEO BOTTLE
- SILVERTEX NEO LIMONCELLO
- SILVERTEX NEO ZEST
- SILVERTEX NEO CELERY
- SILVERTEX NEO SAGE
- SILVERTEX NEO BAZAAR
- SILVERTEX NEO CHAMPAGNE
- SILVERTEX NEO MARSH
- SILVERTEX NEO PEAT
- SILVERTEX NEO MANDARIN
- SILVERTEX NEO CHESTNUT
- SILVERTEX NEO BRONZE
- SILVERTEX NEO TAUPE
- SILVERTEX NEO IMPERIAL
- SILVERTEX NEO POPPY
- SILVERTEX NEO UMBER
- SILVERTEX NEO LUGGAGE
- SILVERTEX NEO MOCHA
- SILVERTEX NEO BORSCHT
- SILVERTEX NEO RASPBERRY
- SILVERTEX NEO BLACKBERRY
- SILVERTEX NEO CREAM
- SILVERTEX NEO ICE
- SILVERTEX NEO BLACK

LINETTE

GRADE ONE - VINYL

BY CULP | VINYL | ABRASION 100,000

- LINETTE ASH
- LINETTE BLACK
- LINETTE COLA
- LINETTE DENIM
- LINETTE FLAME
- LINETTE FROST
- LINETTE GLACIER
- LINETTE GLAZE
- LINETTE MOSS
- LINETTE MUSTARD
- LINETTE PEACOCK
- LINETTE PLATINUM
- LINETTE STEEL
- LINETTE STONE
- LINETTE TOFFEE
- LINETTE WATERSCAPE

CHAMBRAY NEO

GRADE ONE - PRINTED VINYL

BY SPRADLING | VINYL | ABRASION 100,000

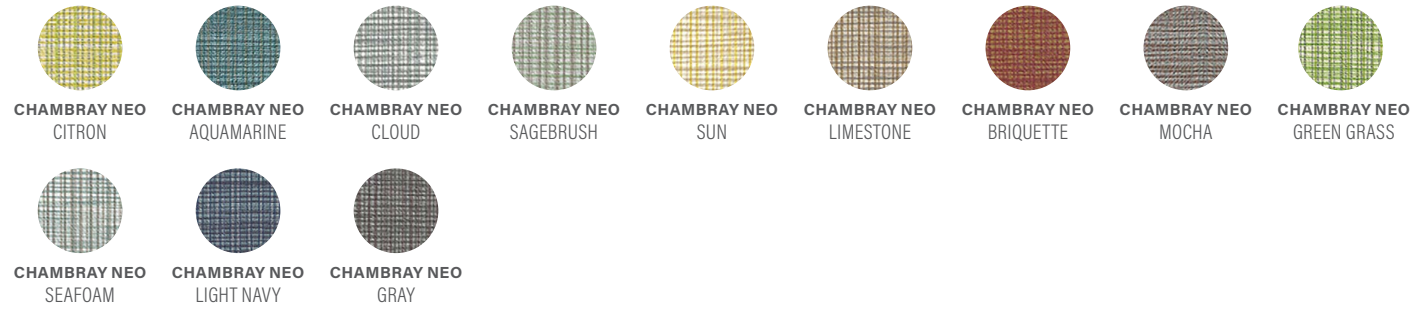

MILANO STITCH

GRADE ONE - PRINTED VINYL

BY SPRADLING | VINYL | ABRASION 100,000



DILLON

GRADE ONE - POLYURETHANE

BY CULP | POLYURETHANE | ABRASION 200,000



VARSITY

GRADE ONE - VINYL

BY MORBERN | VINYL | ABRASION 100,000

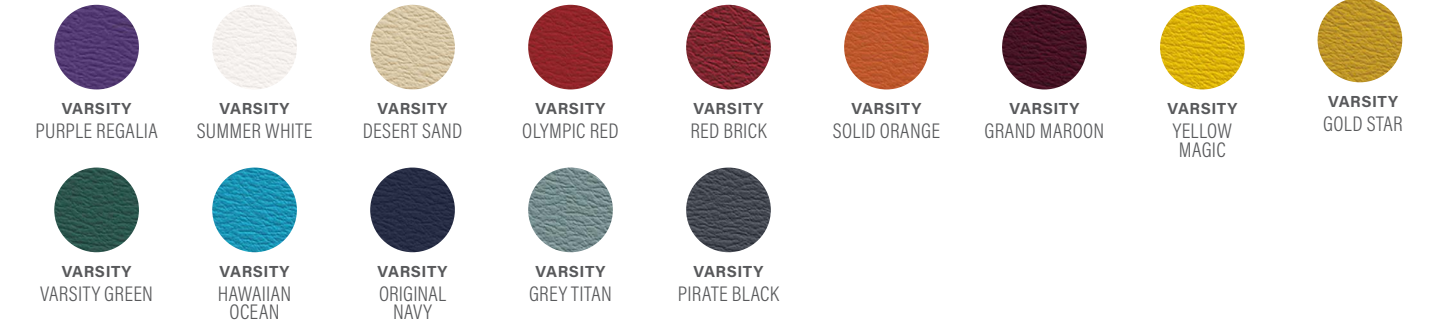

BAYSIDE

GRADE ONE - VINYL

BY MORBERN | VINYL | ABRASION 250,000



 BAYSIDE IS AVAILABLE ON WEATHER RESISTANT AND NON-WEATHER RESISTANT PRODUCTS

SEE ALL TEXTILE GRADES



SCAN or CLICK ME

SILICA CUSP
PIER
GRADE SEVEN



MAKE IT YOUR OWN MODIFICATIONS

1" STANDARD LEG OPTIONS



1" NYLON
GLIDE (G1)



1" FELT
GLIDE (G1)



1" LOW
PROFILE (L1)

3" PREMIUM LEGS & CASTERS



3" RECTANGLE
LEG (R3)



3" CASTER (C3)

6" PREMIUM LEGS & CASTERS



6" CASTER (C6)



6" MOD LEG (M6)



6" RECTANGLE
LEG (R6)



6" TRIANGLE
LEG (T6)



6" SLED LEG
(S16, S29)

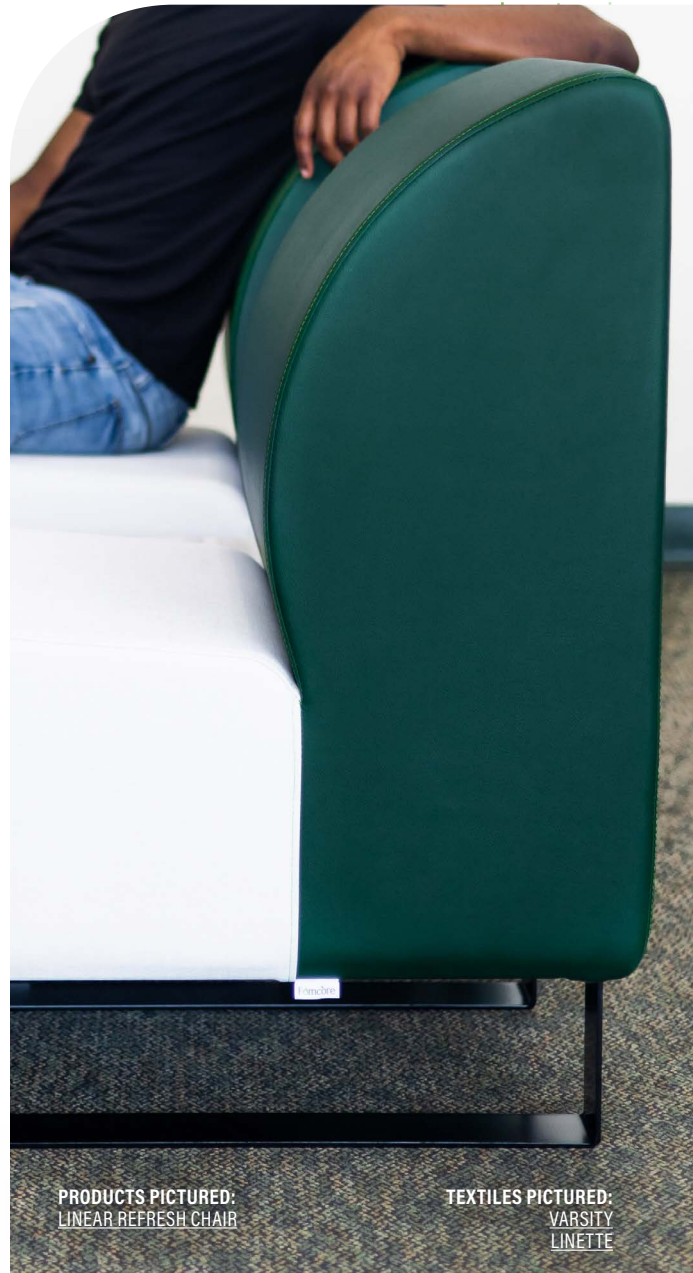

PRODUCTS PICTURED:
LINEAR REFRESH CHAIR

TEXTILES PICTURED:
VARSITY
LINETTE

TFL WORK SURFACE

Top it off! With one of our 6 Thermally Fused Laminate (TFL) work surface options. Add a table top surface to our standard pieces like the Round and Rectangle Ottomans.



MARKER BOARD



NATURAL MAPLE



WHITE WOOD



DARK WOOD



BLACK CRYSTAL



FASHION GREY



PRODUCTS PICTURED:
RECTANGLE OTTOMAN
TEXTILES PICTURED:
SILVERTEX
VARSITY
LINETTE

POWER UP!

Many of our products have the ability to be POWERED UP! Our new embedded power units are a versatile and sleek option when multiple power options are needed in a space. View the Power Reference Guide on pages 63-64 for power placement locations.

- USB/AC combination
- 10' cable length
- For 2 or more power units contact your regional sales director

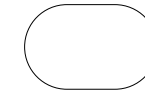

WHITE

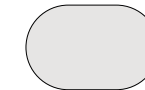

SILVER



PRODUCTS PICTURED:
CONNECT LOW BACK TABLE
TEXTILES PICTURED:
LINETTE

EMBROIDERY

We have the ability to embroider artwork up to 12" x 15" on any item we offer. Let our trained professionals help you showcase your school or company pride; all we need is the high resolution artwork.



TEXTILES PICTURED:
VARSITY
LINETTE



DESIGN SERVICES

HOW CAN WE HELP YOU?

We have the tools, experience, and relationships to help you with your next project no matter how big or small. Our team of designers and engineers are prepared to handle whatever you are dreaming of for your space. Although we are the foam experts specializing in soft-seating, we have partnered with our friends at WB Manufacturing to bring a full range of case-work and hard surfaces to round out your entire space planning experience and meet all of your needs!

YOUR DESIGN RESOURCES:

IN-HOUSE DESIGN SERVICES
 Space Planning
 Technical Design
 Renderings

CUSTOM PRODUCTS
 Concept Design
 Imagery
 Product Testing

DESIGN SYMBOLS
 2D/3D CAD
 Kits Collaborator
 Project Matrix
 Revit
 CET

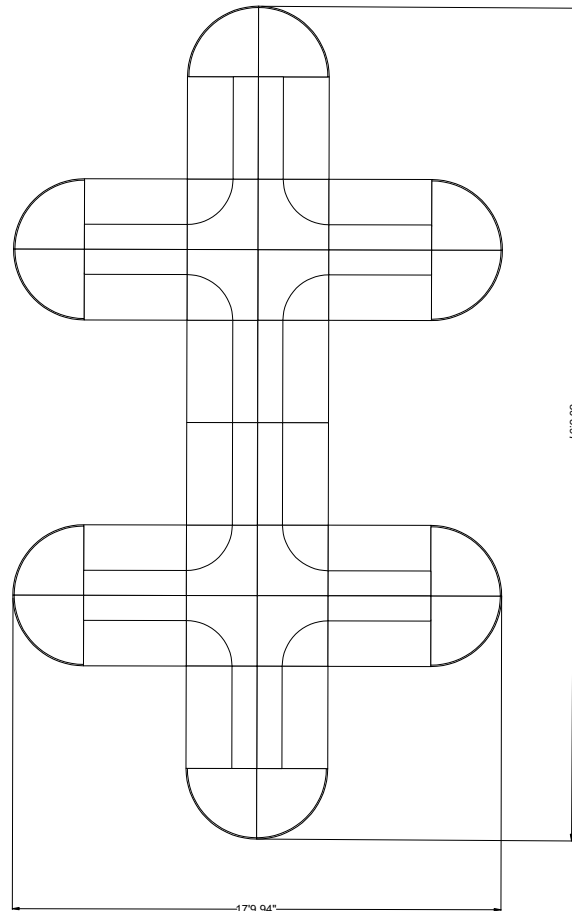

PRODUCTS PICTURED:
 ARMLESS CURVED CORNER
 LINEAR ARMLESS LOVESEAT
 LINEAR WEDGE

TEXTILES PICTURED:
 VARSITY
 LINETTE

LET'S WORK TOGETHER

SCAN or CLICK ME for more details

AT A GLANCE



PRODUCTS PICTURED:
ANDERSON CHAIR
LINEAR LOVESEAT
ARMLESS CURVED CORNER

TEXTILES PICTURED:
VARSITY
LINETTE
BIG DOT



PRODUCTS PICTURED:
LOW ARM CLUB SOCIAL CHAIR

TEXTILES PICTURED:
SILVERTEX



PRODUCTS PICTURED:
HONEYCOMB OTTOMAN

TEXTILES PICTURED:
LINETTE



PRODUCTS PICTURED:
LIL EXPLORERS COMBO 2

TEXTILES PICTURED:
SILVERTEX

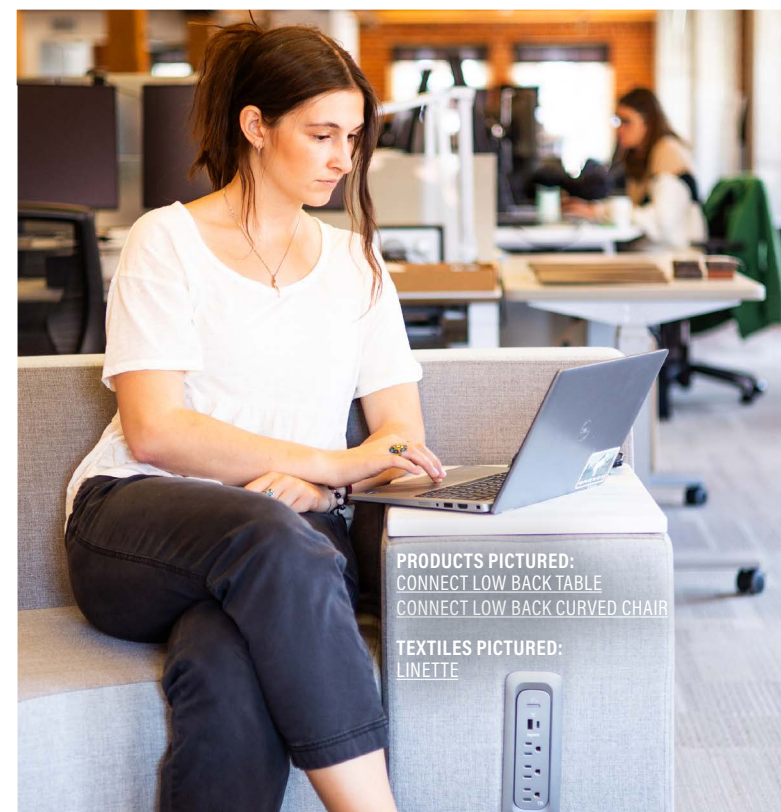

PRODUCTS PICTURED:
CONNECT LOW BACK TABLE
CONNECT LOW BACK CURVED CHAIR

TEXTILES PICTURED:
LINETTE



PRODUCTS PICTURED:
HEX NEST

TEXTILES PICTURED:
BEGUILLED BY THE WILD
SILVERTEX



PRODUCTS PICTURED:
CAMPFIRE COMBO

TEXTILES PICTURED:
SILVERTEX
TREE BARK AND RINGS



PRODUCTS PICTURED:
RECTANGLE OTTOMAN
(WITH TFL)
LINEAR REFRESH SOFA

TEXTILES PICTURED:
VARSITY
LINETTE
SILVERTEX



PRODUCTS PICTURED:
THREE STEP

TEXTILES PICTURED:
MIXOLOGY
EVO



PRODUCTS PICTURED:
GEAR COMBO

TEXTILES PICTURED:
SILVERTEX

WHY FOAM?

SEE THE DIFFERENCE.

NOT-SO "SOFT SEATING"



FŌMCORE



LIFETIME WARRANTY

Our craftsmanship and attention to detail is what allows us to offer a lifetime warranty.* While other products deteriorate over time due to poor structure, our high-quality foam guarantees your Fōmcore products will withstand the test of time.



QUALITY FOAM AND DENSITY

When thin, cheap foam is wrapped around a wood base, it will deteriorate quickly causing puddling. We use the highest quality, 35#, 70#, and 100# foam possible and have formulated our own proprietary formula for maximum durability.



SOLID FOAM vs. WOOD FRAME

While most of our competitors use a wood frame covered by thin layers of foam, our use of solid foam allows for better durability and flexibility. Adapt the space in any environment with ease while at the same time knowing it won't lose its shape over the years.



NO PINCH POINTS

There's no need to worry about squishing any fingers or toes with any of our fully zippered pieces, making our active seating a fun and safe choice.



CUSTOM SHAPES

Because we use solid foam construction, we are able to create and cut an endless variety of custom shapes on our foam saws. From dolphins to dog bones, our team is ready to bring any idea to life.



LIGHT vs. HEAVY

Our lightweight foam construction allows for adaptability in a variety of environments. Other not-so soft seating can be heavy and bulky and difficult to re-arrange quickly and efficiently.



SOFT EDGE vs. HARD EDGE

When fabric is stretched around a thin layer of foam and wood frame, you can feel it! With solid foam construction you will never feel a hard edge no matter how hard you push into the top of the furniture, making it a safe option for virtually any environment.



WATCH A VIDEO ABOUT HOW OUR FOAM COMPARES WITH THE COMPETITION.



SCAN or CLICK ME

*See page 65 for lifetime warranty details.

PETAL OTTOMAN (F101)

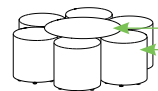

(1) 30" Round Ottoman
(6) Petal Ottomans
6 Petal Ottomans make up a Daisy Combo.
See page 57 for combo details.

Product No.	Dimen./Weight (Dia x H)	FOOT OPTIONS												INTEGRATED POWER OPTIONS												TFL	Emb.								
		Zip Z	Standard			3" Premium			6" Premium						Standard			3" Premium			6" Premium														
		Z	G1	L1	R3	C3	S16	S29	C6	T6	R6	M6	G1	L1	R3	C3	S16	S29	C6	T6	R6	M6	G1	L1	R3	C3	S16	S29	C6	T6	R6	M6			
F101-18x12	18" x 12" 7 lbs.	✓	✓	✓	✓	-	-	-	-	-	✓	✓	-	-	-	-	-	-	-	-	-	-	-	-	-	-	-	-	-	-	-	-	-	✓	✓
F101-18x14	18" x 14" 7 lbs.	✓	✓	✓	✓	-	-	-	-	-	✓	✓	-	-	-	-	-	-	-	-	-	-	-	-	-	-	-	-	-	-	-	-	-	✓	✓
F101-18x16	18" x 16" 8 lbs.	✓	✓	✓	✓	-	-	-	-	-	✓	✓	-	-	-	-	-	-	-	-	-	-	-	-	-	-	-	-	-	-	-	-	✓	✓	
F101-18x18	18" x 18" 8 lbs.	✓	✓	✓	✓	-	-	-	-	-	✓	✓	-	-	-	-	-	-	-	-	-	-	-	-	-	-	-	-	-	-	-	-	✓	✓	
F101-18x20	18" x 20" 9 lbs.	✓	✓	✓	✓	-	-	-	-	-	✓	✓	-	-	-	-	-	-	-	-	-	-	-	-	-	-	-	-	-	-	-	-	✓	✓	

New ROK DROP (F166)



Product No.	Dimen./Weight (L x W x H)	FOOT OPTIONS												INTEGRATED POWER OPTIONS												TFL	Emb.									
		Zip Z	Standard			3" Premium			6" Premium						Standard			3" Premium			6" Premium															
		Z	G1	L1	R3	C3	S16	S29	C6	T6	R6	M6	G1	L1	R3	C3	S16	S29	C6	T6	R6	M6	G1	L1	R3	C3	S16	S29	C6	T6	R6	M6				
Small F166-14x14 (13" Seat Diameter)	14" x 14" 3 lbs.	✓	-	-	-	-	-	-	-	-	-	-	-	-	-	-	-	-	-	-	-	-	-	-	-	-	-	-	-	-	-	-	-	-	✓	✓
Large F166-18x18 (16" Seat Diameter)	18" x 18" 6 lbs.	✓	-	-	-	-	-	-	-	-	-	-	-	-	-	-	-	-	-	-	-	-	-	-	-	-	-	-	-	-	-	-	-	-	✓	✓

AMOEBIA BENCH (F006)

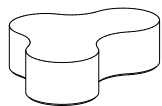

Product No.	Dimen./Weight (L x W x H)	FOOT OPTIONS												INTEGRATED POWER OPTIONS												TFL	Emb.									
		Zip Z	Standard			3" Premium			6" Premium						Standard			3" Premium			6" Premium															
		Z	G1	L1	R3	C3	S16	S29	C6	T6	R6	M6	G1	L1	R3	C3	S16	S29	C6	T6	R6	M6	G1	L1	R3	C3	S16	S29	C6	T6	R6	M6				
F006-48x33.5x14	48" x 33.5" x 14" 27 lbs.	-	✓	✓	✓	✓	-	-	✓	✓	✓	✓	-	-	-	-	-	-	-	-	-	-	-	-	-	-	-	-	-	-	-	-	-	-	✓	✓
F006-48x33.5x16	48" x 33.5" x 16" 29 lbs.	-	✓	✓	✓	✓	-	-	✓	✓	✓	✓	-	-	-	-	-	-	-	-	-	-	-	-	-	-	-	-	-	-	-	-	-	-	✓	✓
F006-48x33.5x18	48" x 33.5" x 18" 30 lbs.	-	✓	✓	✓	✓	-	-	✓	✓	✓	✓	-	-	-	-	-	-	-	-	-	-	-	-	-	-	-	-	-	-	-	-	-	-	✓	✓
F006-48x33.5x20	48" x 33.5" x 20" 31 lbs.	-	✓	✓	✓	✓	-	-	✓	✓	✓	✓	-	-	-	-	-	-	-	-	-	-	-	-	-	-	-	-	-	-	-	-	-	-	✓	✓

BUMP BENCH (F008)



Product No.	Dimen./Weight (L x W x H)	FOOT OPTIONS												INTEGRATED POWER OPTIONS												TFL	Emb.									
		Zip Z	Standard			3" Premium			6" Premium						Standard			3" Premium			6" Premium															
		Z	G1	L1	R3	C3	S16	S29	C6	T6	R6	M6	G1	L1	R3	C3	S16	S29	C6	T6	R6	M6	G1	L1	R3	C3	S16	S29	C6	T6	R6	M6				
F008-96x18x14	96" x 18" x 14" 45 lbs.	-	✓	✓	✓	-	✓	-	✓	✓	✓	✓	-	-	-	-	-	-	-	-	-	-	-	-	-	-	-	-	-	-	-	-	-	-	-	✓
F008-96x18x16	96" x 18" x 16" 48 lbs.	-	✓	✓	✓	-	✓	-	✓	✓	✓	✓	-	-	-	-	-	-	-	-	-	-	-	-	-	-	-	-	-	-	-	-	-	-	-	✓
F008-96x18x18	96" x 18" x 18" 50 lbs.	-	✓	✓	✓	-	✓	-	✓	✓	✓	✓	-	-	-	-	-	-	-	-	-	-	-	-	-	-	-	-	-	-	-	-	-	-	-	✓
F008-96x18x20	96" x 18" x 20" 53 lbs.	-	✓	✓	✓	-	✓	-	✓	✓	✓	✓	-	-	-	-	-	-	-	-	-	-	-	-	-	-	-	-	-	-	-	-	-	-	-	✓

BENCH 48 (F009)

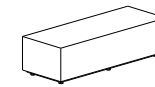

Product No.	Dimen./Weight (L x W x H)	FOOT OPTIONS												INTEGRATED POWER OPTIONS												TFL	Emb.									
		Zip Z	Standard			3" Premium			6" Premium						Standard			3" Premium			6" Premium															
		Z	G1	L1	R3	C3	S16	S29	C6	T6	R6	M6	G1	L1	R3	C3	S16	S29	C6	T6	R6	M6	G1	L1	R3	C3	S16	S29	C6	T6	R6	M6				
F009-48x18x14	48" x 18" x 14" 21 lbs.	✓	✓	✓	✓	✓	✓	-	-	✓	✓	✓	✓	✓	✓	✓	-	-	-	-	-	-	✓	✓	✓	✓	-	-	-	-	-	-	-	-	✓	✓
F009-48x18x16	48" x 18" x 16" 24 lbs.	✓	✓	✓	✓	✓	✓	-	-	✓	✓	✓	✓	✓	✓	✓	-	-	-	-	-	-	✓	✓	✓	✓	-	-	-	-	-	-	-	-	✓	✓
F009-48x18x18	48" x 18" x 18" 26 lbs.	✓	✓	✓	✓	✓	✓	-	-	✓	✓	✓	✓	✓	✓	✓	-	-	-	-	-	-	✓	✓	✓	✓	-	-	✓	✓	✓	✓	✓	✓	✓	✓
F009-48x18x20	48" x 18" x 20" 29 lbs.	✓	✓	✓	✓	✓	✓	-	-	✓	✓	✓	✓	✓	✓	✓	-	-	-	-	-	-	✓	✓	✓	✓	-	-	✓	✓	✓	✓	✓	✓	✓	✓

WEDGE BENCH (F010)

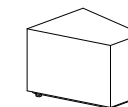

Product No.	Dimen./Weight (L x W x H)	FOOT OPTIONS												INTEGRATED POWER OPTIONS												TFL	Emb.									
		Zip Z	Standard			3" Premium			6" Premium						Standard			3" Premium			6" Premium															
		Z	G1	L1	R3	C3	S16	S29	C6	T6	R6	M6	G1	L1	R3	C3	S16	S29	C6	T6	R6	M6	G1	L1	R3	C3	S16	S29	C6	T6	R6	M6				
F010-21x24x14	21" x 24" x 14" 13 lbs.	✓	✓	✓	✓	-	-	-	-	✓	✓	✓	-	-	-	-	-	-	-	-	-	-	-	-	-	-	-	-	-	-	-	-	-	-	✓	✓
F010-21x24x16	21" x 24" x 16" 14 lbs.	✓	✓	✓	✓	-	-	-	-	✓	✓	✓	-	-	-	-	-	-	-	-	-	-	-	-	-	-	-	-	-	-	-	-	-	-	✓	✓
F010-21x24x18	21" x 24" x 18" 15 lbs.	✓	✓	✓	✓	-	-	-	-	✓	✓	✓	-	-	-	-	-	-	-	-	-	-	-	-	-	-	-	-	-	-	-	-	-	-	✓	✓
F010-21x24x20	21" x 24" x 20" 17 lbs.	✓	✓	✓	✓	-	-	-	-	✓	✓	✓	-	-	-	-	-	-	-	-	-	-	-	-	-	-	-	-	-	-	-	-	-	-	✓	✓

1/4 ROUND BENCH (F011)



Product No.	Dimen./Weight (L x W x H)	FOOT OPTIONS												INTEGRATED POWER OPTIONS												TFL	Emb.									
		Zip Z	Standard			3" Premium			6" Premium						Standard			3" Premium			6" Premium															
		Z	G1	L1	R3	C3	S16	S29	C6	T6	R6	M6	G1	L1	R3	C3	S16	S29	C6	T6	R6	M6	G1	L1	R3	C3	S16	S29	C6	T6	R6	M6				
F011-38x18x14	38" x 18" x 14" 13 lbs.	-	✓	✓	✓	✓	✓	-	-	✓	✓	✓	-	-	-	-	-	-	-	-	-	-	-	-	-	-	-	-	-	-	-	-	-	-	-	✓
F011-38x18x16	38" x 18" x 16" 14 lbs.	-	✓	✓	✓	✓	✓	-	-	✓	✓	✓	-	-	-	-	-	-	-	-	-	-	-	-	-	-	-	-	-	-	-	-	-	-	-	✓
F011-38x18x18	38" x 18" x 18" 15 lbs.	-	✓	✓	✓	✓	✓	-	-	✓	✓	✓	-	-	-	-	-	-	-	-	-	-	-	-	-	-	-	-	-	-	-	-	-	-	-	✓

1/2 ROUND BENCH (F013)

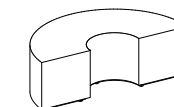

Product No.	Dimen./Weight (L x W x H)	FOOT OPTIONS												INTEGRATED POWER OPTIONS												TFL	Emb.									
		Zip Z	Standard			3" Premium			6" Premium						Standard			3" Premium			6" Premium															
		Z	G1	L1	R3	C3	S16	S29	C6	T6	R6	M6	G1	L1	R3	C3	S16	S29	C6	T6	R6	M6	G1	L1	R3	C3	S16	S29	C6	T6	R6	M6				
F013-54x18x14	54" x 18" x 14" 27 lbs.	-	✓	✓	✓	✓	✓	-	-	✓	✓	✓	-	-	-	-	-	-	-	-	-	-	-	-	-	-	-	-	-	-	-	-	-	-	-	✓
F013-54x18x16	54" x 18" x 16" 29 lbs.	-	✓	✓	✓	✓	✓	-	-	✓	✓	✓	-	-	-	-	-	-	-	-	-	-	-	-	-	-	-	-	-	-	-	-	-	-	-	✓
F013-54x18x18	54" x 18" x 18" 30 lbs.	-	✓	✓	✓	✓	✓	-	-	✓	✓	✓	-	-	-	-																				

ARC BENCH (F015)

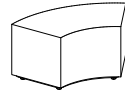

Product No.	Dimen./Weight (L x W x H)	FOOT OPTIONS												INTEGRATED POWER OPTIONS												TFL	Emb.
		Zip Z	Standard			3" Premium			6" Premium			Standard			3" Premium			6" Premium									
		G1	L1	R3	C3	S16	S29	C6	T6	R6	M6	G1	L1	R3	C3	S16	S29	C6	T6	R6	M6						
F015-38x18x14	38" x 18" x 14" 14 lbs.	✓	✓	✓	✓	✓	-	-	✓	✓	✓	-	-	-	-	-	-	-	-	-	-	-	-	✓			
F015-38x18x16	38" x 18" x 16" 16 lbs.	✓	✓	✓	✓	✓	-	-	✓	✓	✓	-	-	-	-	-	-	-	-	-	-	-	-	✓			
F015-38x18x18	38" x 18" x 18" 17 lbs.	✓	✓	✓	✓	✓	-	-	✓	✓	✓	✓	✓	-	-	-	-	-	-	-	-	-	-	✓			
F015-44x18x14	44" x 18" x 14" 17 lbs.	✓	✓	✓	✓	✓	-	-	✓	✓	✓	-	-	-	-	-	-	-	-	-	-	-	-	✓			
F015-44x18x16	44" x 18" x 16" 19 lbs.	✓	✓	✓	✓	✓	-	-	✓	✓	✓	-	-	-	-	-	-	-	-	-	-	-	-	✓			
F015-44x18x18	44" x 18" x 18" 20 lbs.	✓	✓	✓	✓	✓	-	-	✓	✓	✓	✓	✓	-	-	-	-	-	-	-	-	-	-	✓			

BOWTIE BENCH (F077)

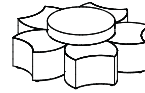

5 Bowtie Benches used in a Bowtie Combo. See page 58 for combo details.

Product No.	Dimen./Weight (L x W x H)	FOOT OPTIONS												INTEGRATED POWER OPTIONS												TFL	Emb.
		Zip Z	Standard			3" Premium			6" Premium			Standard			3" Premium			6" Premium									
		G1	L1	R3	C3	S16	S29	C6	T6	R6	M6	G1	L1	R3	C3	S16	S29	C6	T6	R6	M6						
F077-28x21x14	28" x 21" x 14" 12 lbs.	✓	✓	✓	✓	✓	-	-	✓	✓	✓	-	-	-	-	-	-	-	-	-	-	-	-	✓			
F077-28x21x16	28" x 21" x 16" 13 lbs.	✓	✓	✓	✓	✓	-	-	✓	✓	✓	-	-	-	-	-	-	-	-	-	-	-	-	✓			
F077-28x21x18	28" x 21" x 18" 14 lbs.	✓	✓	✓	✓	✓	-	-	✓	✓	✓	-	-	-	-	-	-	-	-	-	-	-	-	✓			
F077-28x21x20	28" x 21" x 20" 15 lbs.	✓	✓	✓	✓	✓	-	-	✓	✓	✓	-	-	-	-	-	-	-	-	-	-	-	-	✓			

ROLLING HILLS (F127)



3 Rolling Hills connected together

Product No.	Dimen./Weight (L x W x H)	FOOT OPTIONS												INTEGRATED POWER OPTIONS												TFL	Emb.
		Zip Z	Standard			3" Premium			6" Premium			Standard			3" Premium			6" Premium									
		G1	L1	R3	C3	S16	S29	C6	T6	R6	M6	G1	L1	R3	C3	S16	S29	C6	T6	R6	M6						
F127-73.6x42.5x17	73.6" x 42.5" x 17" 66 lbs.	-	✓	✓	-	-	-	-	-	-	-	-	-	-	-	-	-	-	-	-	-	-	-	✓			

Armless Series - Curved Armless

DETAILS

CONSTRUCTION:

- Solid foam construction
- Reinforced seams and stitching
- Wood baseboard to fit foot options
- Waterfall edge
- Made in USA
- Backed with a lifetime warranty *See page 65

MODIFICATION:

- Seat height
- Textile and placement
- Leg, caster, and foot options
- Stitching color
- Embroidery

CURVED BENCH 60 (F106)

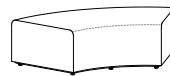

Product No.	Dimen./Weight (L x W x H)	FOOT OPTIONS												INTEGRATED POWER OPTIONS												TFL	Emb.
		Zip Z	Standard			3" Premium			6" Premium			Standard			3" Premium			6" Premium									
		G1	L1	R3	C3	S16	S29	C6	T6	R6	M6	G1	L1	R3	C3	S16	S29	C6	T6	R6	M6						
F106-67x31x16	67" x 31" x 16" 47 lbs.	-	✓	✓	✓	✓	-	✓	✓	✓	✓	-	-	-	-	-	-	-	-	-	-	-	-	✓			
F106-67x31x18	67" x 31" x 18" 50 lbs.	-	✓	✓	✓	✓	-	✓	✓	✓	✓	-	-	-	-	-	-	-	-	-	-	-	-	✓			

CURVED BENCH 30 (F108)

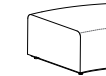

Product No.	Dimen./Weight (L x W x H)	FOOT OPTIONS												INTEGRATED POWER OPTIONS												TFL	Emb.
		Zip Z	Standard			3" Premium			6" Premium			Standard			3" Premium			6" Premium									
		G1	L1	R3	C3	S16	S29	C6	T6	R6	M6	G1	L1	R3	C3	S16	S29	C6	T6	R6	M6						
F108-34.75x31x16	34.75" x 31" x 16" 24 lbs.	-	✓	✓	✓	✓	-	✓	✓	✓	✓	-	-	-	-	-	-	-	-	-	-	-	-	✓			
F108-34.75x31x18	34.75" x 31" x 18" 25 lbs.	-	✓	✓	✓	✓	-	✓	✓	✓	✓	-	-	-	-	-	-	-	-	-	-	-	-	✓			

CURVED LOVESEAT (F018)

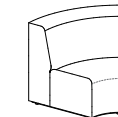

Product No.	Dimen./Weight (L x W x H)	FOOT OPTIONS												INTEGRATED POWER OPTIONS												TFL	Emb.
		Zip Z	Standard			3" Premium			6" Premium			Standard			3" Premium			6" Premium									
		G1	L1	R3	C3	S16	S29	C6	T6	R6	M6	G1	L1	R3	C3	S16	S29	C6	T6	R6	M6						
F018-45x31x33	45" x 31" x 33" 34 lbs. (16" Seat Height)	-	✓	✓	✓	✓	-	✓	✓	✓	✓	-	-	-	-	-	-	-	-	-	-	-	-	✓			
F018-45x31x35	45" x 31" x 35" 35 lbs. (18" Seat Height)	-	✓	✓	✓	✓	-	✓	✓	✓	✓	-	-	-	-	-	-	-	-	-	-	-	-	✓			

CURVED SOFA IN (F020)

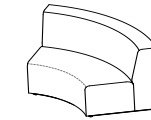

Product No.	Dimen./Weight (L x W x H)	FOOT OPTIONS												INTEGRATED POWER OPTIONS												TFL	Emb.
		Zip Z	Standard			3" Premium			6" Premium			Standard			3" Premium			6" Premium									
		G1	L1	R3	C3	S16	S29	C6	T6	R6	M6	G1	L1	R3	C3	S16	S29	C6	T6	R6	M6						
F020-67x31x33	67" x 31" x 33" 60 lbs. (16" Seat Height)	-	✓	✓	✓	✓	-	✓	✓	✓	✓	-	-	-	-	-	-	-	-	-	-	-	-	✓			
F020-67x31x35	67" x 31" x 35" 67 lbs. (18" Seat Height)	-	✓	✓	✓	✓	-	✓	✓	✓	✓	-	-	-	-	-	-	-	-	-	-	-	-	✓			

CURVED OUTSIDE SOFA 40 (F109)

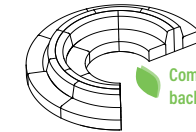
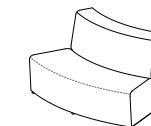

Combine F020's with F109's to create back to back seating

Product No.	Dimen./Weight (L x W x H)	FOOT OPTIONS												INTEGRATED POWER OPTIONS												TFL	Emb.
		Zip Z	Standard			3" Premium			6" Premium			Standard			3" Premium			6" Premium									
		G1	L1	R3	C3	S16	S29	C6	T6	R6	M6	G1	L1	R3	C3	S16	S29	C6	T6	R6	M6						
F109-67x31x33	67" x 31" x 33" 58 lbs. (16" Seat Height)	-	✓	✓	✓	✓	-	✓	✓	✓	✓	-	-	-	-	-	-	-	-	-	-	-	-	✓			
F109-67x31x35	67" x 31" x 35" 62 lbs. (18" Seat Height)	-	✓	✓	✓	✓	-	✓	✓	✓	✓	-	-	-	-	-	-	-	-	-	-	-	-	✓			

ARMLESS CURVED CORNER (F061)

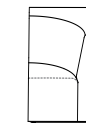

Product No.	Dimen./Weight (L x W x H)	FOOT OPTIONS												INTEGRATED POWER OPTIONS												TFL	Emb.
		Zip Z	Standard			3" Premium			6" Premium			Standard			3" Premium			6" Premium									
		G1	L1	R3	C3	S16	S29	C6	T6	R6	M6	G1	L1	R3	C3	S16	S29	C6	T6	R6	M6						
F061-31x31x33	31" x 31" x 33" 37 lbs. (16" Seat Height)	-	✓	✓	✓	✓	-	✓	✓	✓	✓	-	-	-	-	-	-	-	-	-	-	-	-	✓			
F061-31x31x35	31" x 31" x 35" 39 lbs. (18" Seat Height)	-	✓	✓	✓	✓	-	✓	✓	✓	✓	-	-	-	-	-	-	-	-	-	-	-	-	✓			

LINEAR REFRESH LOVESEAT (F140)

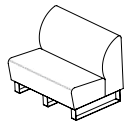

Product No.	Dimen./Weight (L x W x H)	FOOT OPTIONS										INTEGRATED POWER OPTIONS										TFL	Emb.
		Zip Z	Standard G1 L1		3" Premium R3 C3		6" Premium S16 S29		C6 T6	R6 M6	Standard G1 L1		3" Premium R3 C3		6" Premium S16 S29		C6 T6	R6 M6					
F140-45x32.5x33	45" x 32.5" x 33" 60 lbs. (16" Seat Height)	-	✓	✓	✓	✓	-	✓	✓	✓	✓	✓	✓	✓	✓	✓	✓	✓	✓	✓	✓	-	✓
F140-45x32.5x35	45" x 32.5" x 35" 62.5 lbs. (18" Seat Height)	-	✓	✓	✓	✓	-	✓	✓	✓	✓	✓	✓	✓	✓	✓	✓	✓	✓	✓	✓	-	✓

LINEAR REFRESH SOFA (F141)

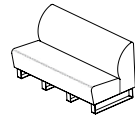

Product No.	Dimen./Weight (L x W x H)	FOOT OPTIONS										INTEGRATED POWER OPTIONS										TFL	Emb.
		Zip Z	Standard G1 L1		3" Premium R3 C3		6" Premium S16 S29		C6 T6	R6 M6	Standard G1 L1		3" Premium R3 C3		6" Premium S16 S29		C6 T6	R6 M6					
F141-67x32.5x33	67" x 32.5" x 33" 86 lbs. (16" Seat Height)	-	✓	✓	✓	✓	-	✓	✓	✓	✓	✓	✓	✓	✓	✓	✓	✓	✓	✓	✓	-	✓
F141-67x32.5x35	67" x 32.5" x 35" 90 lbs. (18" Seat Height)	-	✓	✓	✓	✓	-	✓	✓	✓	✓	✓	✓	✓	✓	✓	✓	✓	✓	✓	✓	-	✓

LINEAR REFRESH OTTOMAN (F142)



Product No.	Dimen./Weight (L x W x H)	FOOT OPTIONS										INTEGRATED POWER OPTIONS										TFL	Emb.
		Zip Z	Standard G1 L1		3" Premium R3 C3		6" Premium S16 S29		C6 T6	R6 M6	Standard G1 L1		3" Premium R3 C3		6" Premium S16 S29		C6 T6	R6 M6					
F142-22x19.2x16	22" x 19.2" x 16" 18 lbs.	-	✓	✓	✓	✓	-	✓	✓	✓	✓	-	-	-	-	-	-	-	-	-	-	-	✓
F142-22x19.2x18	22" x 19.2" x 18" 19 lbs.	-	✓	✓	✓	✓	-	✓	✓	✓	✓	-	-	-	-	-	-	-	-	-	-	-	✓

LINEAR REFRESH BENCH (F143)

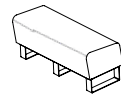

Product No.	Dimen./Weight (L x W x H)	FOOT OPTIONS										INTEGRATED POWER OPTIONS										TFL	Emb.
		Zip Z	Standard G1 L1		3" Premium R3 C3		6" Premium S16 S29		C6 T6	R6 M6	Standard G1 L1		3" Premium R3 C3		6" Premium S16 S29		C6 T6	R6 M6					
F143-45x19.2x16	45" x 19.2" x 16" 32 lbs.	-	✓	✓	✓	✓	-	✓	✓	✓	✓	-	-	-	-	-	-	-	-	-	-	-	✓
F143-45x19.2x18	45" x 19.2" x 18" 34 lbs.	-	✓	✓	✓	✓	-	✓	✓	✓	✓	-	-	-	-	-	-	-	-	-	-	-	✓

DETAILS

CONSTRUCTION:

- Solid foam construction
- Reinforced seams and stitching
- Wood baseboard to fit foot options
- Made in USA
- Backed with a lifetime warranty
- *See page 65

MODIFICATION:

- Seat height
- Textile and placement
- Leg, caster, and foot options
- Stitching color
- Power options
- TFL work surface
- Embroidery

CONNECT LOW BACK SOFA (F133)

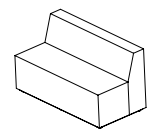

Product No.	Dimen./Weight (L x W x H)	FOOT OPTIONS										INTEGRATED POWER OPTIONS										TFL	Emb.
		Zip Z	Standard G1 L1		3" Premium R3 C3		6" Premium S16 S29		C6 T6	R6 M6	Standard G1 L1		3" Premium R3 C3		6" Premium S16 S29		C6 T6	R6 M6					
F133-48x28x31	48" x 28" x 31" 53 lbs. (18" Seat Height)	-	✓	✓	✓	✓	-	✓	✓	✓	✓	✓	✓	✓	✓	✓	✓	✓	✓	✓	✓	-	✓

CONNECT LOW BACK CURVED CHAIR (F134)

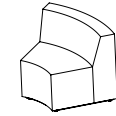

Product No.	Dimen./Weight (L x W x H)	FOOT OPTIONS										INTEGRATED POWER OPTIONS										TFL	Emb.
		Zip Z	Standard G1 L1		3" Premium R3 C3		6" Premium S16 S29		C6 T6	R6 M6	Standard G1 L1		3" Premium R3 C3		6" Premium S16 S29		C6 T6	R6 M6					
F134-40x28x31	40" x 28" x 31" 30 lbs. (18" Seat Height)	-	✓	✓	✓	✓	-	-	✓	✓	✓	✓	✓	✓	✓	✓	✓	✓	✓	✓	✓	-	✓

CONNECT LOW BACK CHAIR (F135)

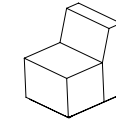

Product No.	Dimen./Weight (L x W x H)	FOOT OPTIONS										INTEGRATED POWER OPTIONS										TFL	Emb.
		Zip Z	Standard G1 L1		3" Premium R3 C3		6" Premium S16 S29		C6 T6	R6 M6	Standard G1 L1		3" Premium R3 C3		6" Premium S16 S29		C6 T6	R6 M6					
F135-24x28x31	24" x 28" x 31" 23 lbs. (18" Seat Height)	-	✓	✓	✓	✓	-	-	✓	✓	✓	✓	✓	✓	✓	✓	✓	✓	✓	✓	✓	-	✓

CONNECT LOW BACK SOFA RIGHT HAND (F136)

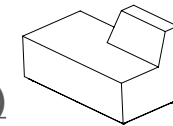

Product No.	Dimen./Weight (L x W x H)	FOOT OPTIONS										INTEGRATED POWER OPTIONS										TFL	Emb.
		Zip Z	Standard G1 L1		3" Premium R3 C3		6" Premium S16 S29		C6 T6	R6 M6	Standard G1 L1		3" Premium R3 C3		6" Premium S16 S29		C6 T6	R6 M6					
F136-48x28x31	48" x 28" x 31" 48 lbs. (18" Seat Height)	-	✓	✓	✓	✓	-	-	✓	✓	✓	✓	-	-	-	-	-	-	-	-	-	-	✓

CONNECT LOW BACK SOFA LEFT HAND (F137)

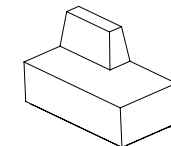

Product No.	Dimen./Weight (L x W x H)	FOOT OPTIONS										INTEGRATED POWER OPTIONS										TFL	Emb.
		Zip Z	Standard G1 L1		3" Premium R3 C3		6" Premium S16 S29		C6 T6	R6 M6	Standard G1 L1		3" Premium R3 C3		6" Premium S16 S29		C6 T6	R6 M6					
F137-48x28x31	48" x 28" x 31" 48 lbs. (18" Seat Height)	-	✓	✓	✓	✓	-	-	✓	✓	✓	✓	-	-	-	-	-	-	-	-	-	-	✓

CONNECT LOW BACK TABLE (F138)

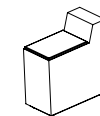

Product No.	Dimen./Weight (L x W x H)	FOOT OPTIONS										INTEGRATED POWER OPTIONS										TFL	Emb.
		Zip Z	Standard G1 L1		3" Premium R3 C3		6" Premium S16 S29		C6 T6	R6 M6	Standard G1 L1		3" Premium R3 C3		6" Premium S16 S29		C6 T6	R6 M6					
F138-14x28x31	14" x 28" x 31" 19 lbs.	-	✓	✓	✓	✓	-	-	-	✓	✓	✓	✓	✓	✓	✓	✓	✓	✓	✓	✓	incl.	✓

DETAILS

CONSTRUCTION:

- Solid foam construction
- Reinforced seams and stitching
- Wood baseboard to fit foot options
- Clean out profile
- Made in USA
- Backed with a lifetime warranty
- *See page 65

MODIFICATION:

- Textile and placement
- 6" leg and caster options
- Stitching color
- Power options
- Embroidery

CAFÉ BOOTH (F131)

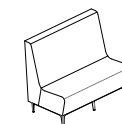

Product No.	Dimen./Weight (L x W x H)	FOOT OPTIONS										INTEGRATED POWER OPTIONS										TFL	Emb.
		Zip Z	Standard G1 L1		3" Premium R3 C3		6" Premium S16 S29		C6 T6	R6 M6	Standard G1 L1		3" Premium R3 C3		6" Premium S16 S29		C6 T6	R6 M6					
F131-48x28.5x42	48" x 28.5" x 42" 53 lbs. (18" Seat Height)	-	-	-	-	-	-	-	✓	✓	✓	✓	-	-	-	-	-	-	-	-	-	-	✓

PET PANEL - CAFÉ SEPARATOR (PA131)

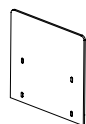

Panel attaches to the back of the Café Booth and is only available in Heather Grey

Product No.	Dimen./Weight (L x W x H)	FOOT OPTIONS										INTEGRATED POWER OPTIONS										TFL	Emb.	
		Zip Z	Standard			3" Premium		6" Premium					Standard			3" Premium		6" Premium						
PA131	48" x 50" x 1" 10 lbs.	Z	G1	L1	R3	C3	S16	S29	C6	T6	R6	M6	G1	L1	R3	C3	S16	S29	C6	T6	R6	M6	TFL	Emb.
		-	-	-	-	-	-	-	-	-	-	-	-	-	-	-	-	-	-	-	-	-	-	-

Social Series

DETAILS

CONSTRUCTION:

- Solid foam construction
- Reinforced seams and stitching
- Wood baseboard to fit foot options
- Made in USA
- Backed with a lifetime warranty
- *See page 65

MODIFICATION:

- Textile and placement
- Leg, caster, and foot options
- Stitching color
- TFL work surface
- Power options
- Embroidery

CLUB SOCIAL CHAIR (F050)

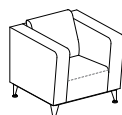

Product No.	Dimen./Weight (L x W x H)	FOOT OPTIONS										INTEGRATED POWER OPTIONS										TFL	Emb.	
		Zip Z	Standard			3" Premium		6" Premium					Standard			3" Premium		6" Premium						
F050-35x36x32	35" x 36" x 32" 44 lbs.	Z	G1	L1	R3	C3	S16	S29	C6	T6	R6	M6	G1	L1	R3	C3	S16	S29	C6	T6	R6	M6	TFL	Emb.
		-	-	-	-	-	-	-	✓	✓	✓	✓	✓	-	-	-	-	✓	✓	✓	✓	✓	-	✓

LEFT SOCIAL CHAIR (F051)



Product No.	Dimen./Weight (L x W x H)	FOOT OPTIONS										INTEGRATED POWER OPTIONS										TFL	Emb.	
		Zip Z	Standard			3" Premium		6" Premium					Standard			3" Premium		6" Premium						
F051-28.25x36x32	28.25" x 36" x 32" 35 lbs.	Z	G1	L1	R3	C3	S16	S29	C6	T6	R6	M6	G1	L1	R3	C3	S16	S29	C6	T6	R6	M6	TFL	Emb.
		-	-	-	-	-	-	-	✓	✓	✓	✓	✓	-	-	-	-	✓	✓	✓	✓	✓	-	✓

RIGHT SOCIAL CHAIR (F052)



Product No.	Dimen./Weight (L x W x H)	FOOT OPTIONS										INTEGRATED POWER OPTIONS										TFL	Emb.	
		Zip Z	Standard			3" Premium		6" Premium					Standard			3" Premium		6" Premium						
F052-28.25x36x32	28.25" x 36" x 32" 35 lbs.	Z	G1	L1	R3	C3	S16	S29	C6	T6	R6	M6	G1	L1	R3	C3	S16	S29	C6	T6	R6	M6	TFL	Emb.
		-	-	-	-	-	-	-	✓	✓	✓	✓	✓	-	-	-	-	✓	✓	✓	✓	✓	-	✓

LOW ARM CLUB SOCIAL CHAIR (F150)



Product No.	Dimen./Weight (L x W x H)	FOOT OPTIONS										INTEGRATED POWER OPTIONS										TFL	Emb.	
		Zip Z	Standard			3" Premium		6" Premium					Standard			3" Premium		6" Premium						
F150-35x34.75x32	35" x 34.75" x 32" 40 lbs.	Z	G1	L1	R3	C3	S16	S29	C6	T6	R6	M6	G1	L1	R3	C3	S16	S29	C6	T6	R6	M6	TFL	Emb.
		-	-	-	-	-	-	-	✓	✓	✓	✓	✓	-	-	-	-	✓	✓	✓	✓	✓	✓	✓

LOW ARM LEFT SOCIAL CHAIR (F151)



Product No.	Dimen./Weight (L x W x H)	FOOT OPTIONS										INTEGRATED POWER OPTIONS										TFL	Emb.	
		Zip Z	Standard			3" Premium		6" Premium					Standard			3" Premium		6" Premium						
F151-28.25x34.75x32	28.25" x 34.75" x 32" 32 lbs.	Z	G1	L1	R3	C3	S16	S29	C6	T6	R6	M6	G1	L1	R3	C3	S16	S29	C6	T6	R6	M6	TFL	Emb.
		-	-	-	-	-	-	-	✓	✓	✓	✓	✓	-	-	-	-	✓	✓	✓	✓	✓	✓	✓

LOW ARM RIGHT SOCIAL CHAIR (F152)



Product No.	Dimen./Weight (L x W x H)	FOOT OPTIONS										INTEGRATED POWER OPTIONS										TFL	Emb.	
		Zip Z	Standard			3" Premium		6" Premium					Standard			3" Premium		6" Premium						
F152-28.25x34.75x32	28.25" x 34.75" x 32" 32 lbs.	Z	G1	L1	R3	C3	S16	S29	C6	T6	R6	M6	G1	L1	R3	C3	S16	S29	C6	T6	R6	M6	TFL	Emb.
		-	-	-	-	-	-	-	✓	✓	✓	✓	✓	-	-	-	-	✓	✓	✓	✓	✓	✓	✓

ARMLESS SOCIAL CHAIR (F053)



Product No.	Dimen./Weight (L x W x H)	FOOT OPTIONS										INTEGRATED POWER OPTIONS										TFL	Emb.	
		Zip Z	Standard			3" Premium		6" Premium					Standard			3" Premium		6" Premium						
F053-21.5x36x32	21.5" x 36" x 32" 24 lbs.	Z	G1	L1	R3	C3	S16	S29	C6	T6	R6	M6	G1	L1	R3	C3	S16	S29	C6	T6	R6	M6	TFL	Emb.
		-	-	-	-	-	-	-	✓	✓	✓	✓	✓	-	-	-	-	✓	✓	✓	✓	✓	-	✓

DETAILS

CONSTRUCTION:

- Solid foam construction
- Reinforced seams and stitching
- Fully zippered (no wood base)
- Patented design
- Made in USA
- Backed with a lifetime warranty
- *See page 65

MODIFICATION:

- Textile and placement
- Stitching and zipper colors
- Embroidery

ROBIN'S NEST (F536)

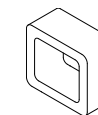

Product No.	Dimen./Weight (L x W x H)	FOOT OPTIONS										INTEGRATED POWER OPTIONS										TFL	Emb.	
		Zip Z	Standard			3" Premium		6" Premium					Standard			3" Premium		6" Premium						
F536-45x21.25x39	45" x 21.25" x 39" 24 lbs.	Z	G1	L1	R3	C3	S16	S29	C6	T6	R6	M6	G1	L1	R3	C3	S16	S29	C6	T6	R6	M6	TFL	Emb.
		✓	-	-	-	-	-	-	-	-	-	-	-	-	-	-	-	-	-	-	-	-	-	✓

ROBIN'S EGG PAD (F960)

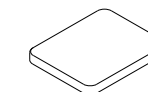

6 pads fit into the Robin's Nest

Product No.	Dimen./Weight (L x W x H)	FOOT OPTIONS										INTEGRATED POWER OPTIONS										TFL	Emb.	
		Zip Z	Standard			3" Premium		6" Premium					Standard			3" Premium		6" Premium						
F960-33x27x3	33" x 27" x 3" 3 lbs.	Z	G1	L1	R3	C3	S16	S29	C6	T6	R6	M6	G1	L1	R3	C3	S16	S29	C6	T6	R6	M6	TFL	Emb.
		✓	-	-	-	-	-	-	-	-	-	-	-	-	-	-	-	-	-	-	-	-	-	✓

EAGLE'S NEST (F586)

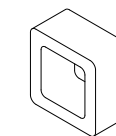

Product No.	Dimen./Weight (L x W x H)	FOOT OPTIONS										INTEGRATED POWER OPTIONS										TFL	Emb.	
		Zip Z	Standard			3" Premium		6" Premium					Standard			3" Premium		6" Premium						
F586-57x24x51	57" x 24" x 51" 42 lbs.	Z	G1	L1	R3	C3	S16	S29	C6	T6	R6	M6	G1	L1	R3	C3	S16	S29	C6	T6	R6	M6	TFL	Emb.
		✓	-	-	-	-	-	-	-	-	-	-	-	-	-	-	-	-	-	-	-	-	-	✓

EAGLE'S EGG PAD (F713)

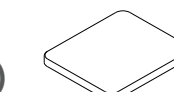

7 pads fit into the Eagle's Nest

Product No.	Dimen./Weight (L x W x H)	FOOT OPTIONS										INTEGRATED POWER OPTIONS										TFL	Emb.	
		Zip Z	Standard			3" Premium		6" Premium					Standard			3" Premium		6" Premium						
F713-40x34.5x3	40" x 34.5" x 3" 4 lbs.	Z	G1	L1	R3	C3	S16	S29	C6	T6	R6	M6	G1	L1	R3	C3	S16	S29	C6	T6	R6	M6	TFL	Emb.
		✓	-	-	-	-	-	-	-	-	-	-	-	-	-	-	-	-	-	-	-	-	-	✓

ORIOLE'S NEST (F091)



Product No.	Dimen./Weight (L x W x H)	FOOT OPTIONS										INTEGRATED POWER OPTIONS										TFL	Emb.					
		Zip Z	Standard G1 L1		3" Premium R3 C3		6" Premium S16 S29 C6 T6 R6 M6				Standard G1 L1		3" Premium R3 C3		6" Premium S16 S29 C6 T6 R6 M6													
F091-48x21x56.5	48" x 21" x 56.5" 35 lbs.	✓	-	-	-	-	-	-	-	-	-	-	-	-	-	-	-	-	-	-	-	-	-	-	-	-	-	✓

FALCON'S NEST (F086)



Product No.	Dimen./Weight (L x W x H)	FOOT OPTIONS										INTEGRATED POWER OPTIONS										TFL	Emb.					
		Zip Z	Standard G1 L1		3" Premium R3 C3		6" Premium S16 S29 C6 T6 R6 M6				Standard G1 L1		3" Premium R3 C3		6" Premium S16 S29 C6 T6 R6 M6													
F086-64x24x65	64" x 24" x 65" 49 lbs.	✓	-	-	-	-	-	-	-	-	-	-	-	-	-	-	-	-	-	-	-	-	-	-	-	-	-	✓

LUG NEST (F129)

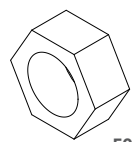

Product No.	Dimen./Weight (L x W x H)	FOOT OPTIONS										INTEGRATED POWER OPTIONS										TFL	Emb.					
		Zip Z	Standard G1 L1		3" Premium R3 C3		6" Premium S16 S29 C6 T6 R6 M6				Standard G1 L1		3" Premium R3 C3		6" Premium S16 S29 C6 T6 R6 M6													
F129-58.9x24x51	58.9" x 24" x 51" 39 lbs.	✓	-	-	-	-	-	-	-	-	-	-	-	-	-	-	-	-	-	-	-	-	-	-	-	-	-	✓

HEX NEST (F130)

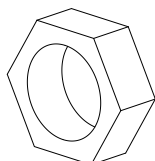

Product No.	Dimen./Weight (L x W x H)	FOOT OPTIONS										INTEGRATED POWER OPTIONS										TFL	Emb.					
		Zip Z	Standard G1 L1		3" Premium R3 C3		6" Premium S16 S29 C6 T6 R6 M6				Standard G1 L1		3" Premium R3 C3		6" Premium S16 S29 C6 T6 R6 M6													
F130-72.75x24x63	72.75" x 24" x 63" 53 lbs.	✓	-	-	-	-	-	-	-	-	-	-	-	-	-	-	-	-	-	-	-	-	-	-	-	-	-	✓

ORIOLE'S/LUG EGG PAD (F083)



6 pads fit in the Oriole Nest
7 pads fit in the Lug Nest

Product No.	Dimen./Weight (Dia. x H)	FOOT OPTIONS										INTEGRATED POWER OPTIONS										TFL	Emb.					
		Zip Z	Standard G1 L1		3" Premium R3 C3		6" Premium S16 S29 C6 T6 R6 M6				Standard G1 L1		3" Premium R3 C3		6" Premium S16 S29 C6 T6 R6 M6													
F083-35x3	35" x 3" 3 lbs.	✓	-	-	-	-	-	-	-	-	-	-	-	-	-	-	-	-	-	-	-	-	-	-	-	-	-	✓

FALCON'S/HEX EGG PAD (F084)

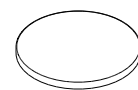

7 pads fit in the Hex and Falcon Nest

Product No.	Dimen./Weight (Dia. x H)	FOOT OPTIONS										INTEGRATED POWER OPTIONS										TFL	Emb.					
		Zip Z	Standard G1 L1		3" Premium R3 C3		6" Premium S16 S29 C6 T6 R6 M6				Standard G1 L1		3" Premium R3 C3		6" Premium S16 S29 C6 T6 R6 M6													
F084-47x3	47" x 3" 5 lbs.	✓	-	-	-	-	-	-	-	-	-	-	-	-	-	-	-	-	-	-	-	-	-	-	-	-	-	✓

EAGLE'S NEST ENCLOSURE (PA067)

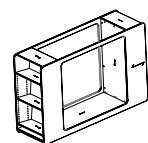

Product No.	Dimen./Weight (L x W x H)	FOOT OPTIONS										INTEGRATED POWER OPTIONS										TFL	Emb.					
		Zip Z	Standard G1 L1		3" Premium R3 C3		6" Premium S16 S29 C6 T6 R6 M6				Standard G1 L1		3" Premium R3 C3		6" Premium S16 S29 C6 T6 R6 M6													
PA067	86" x 25.5" x 54" 361 lbs.	-	-	-	-	-	-	-	-	-	-	-	-	-	-	-	-	-	-	-	-	-	-	-	-	-	-	-

DETAILS

CONSTRUCTION:

- Solid foam construction
- Reinforced seams and stitching
- Wood baseboard to fit foot options
- Made in USA
- Backed with a lifetime warranty
*See page 65

MODIFICATION:

- Textile and placement
- Leg and foot options
- Stitching color
- Power options
- Embroidery

TWO STEP (F027)

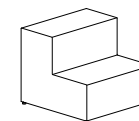

Product No.	Dimen./Weight (L x W x H)	FOOT OPTIONS										INTEGRATED POWER OPTIONS										TFL	Emb.					
		Zip Z	Standard G1 L1		3" Premium R3 C3		6" Premium S16 S29 C6 T6 R6 M6				Standard G1 L1		3" Premium R3 C3		6" Premium S16 S29 C6 T6 R6 M6													
F027-38x38x32	38" x 38" x 32" 52 lbs.	-	✓	✓	-	-	-	-	-	-	-	-	-	-	-	-	-	-	✓	✓	-	-	-	-	-	-	-	✓

TWO STEP INSIDE CORNER (F029)

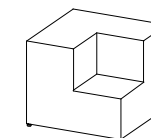

Product No.	Dimen./Weight (L x W x H)	FOOT OPTIONS										INTEGRATED POWER OPTIONS										TFL	Emb.					
		Zip Z	Standard G1 L1		3" Premium R3 C3		6" Premium S16 S29 C6 T6 R6 M6				Standard G1 L1		3" Premium R3 C3		6" Premium S16 S29 C6 T6 R6 M6													
F029-38x38x32	38" x 38" x 32" 58 lbs.	-	✓	✓	-	-	-	-	-	-	-	-	-	-	-	-	-	-	✓	✓	-	-	-	-	-	-	-	✓

TWO STEP OUTSIDE CORNER (F030)

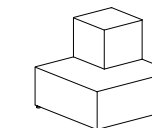

Product No.	Dimen./Weight (L x W x H)	FOOT OPTIONS										INTEGRATED POWER OPTIONS										TFL	Emb.					
		Zip Z	Standard G1 L1		3" Premium R3 C3		6" Premium S16 S29 C6 T6 R6 M6				Standard G1 L1		3" Premium R3 C3		6" Premium S16 S29 C6 T6 R6 M6													
F030-38x38x32	38" x 38" x 32" 47 lbs.	-	✓	✓	-	-	-	-	-	-	-	-	-	-	-	-	-	-	✓	✓	-	-	-	-	-	-	-	✓

THREE STEP (F028)

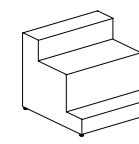

Product No.	Dimen./Weight (L x W x H)	FOOT OPTIONS										INTEGRATED POWER OPTIONS										TFL	Emb.					
		Zip Z	Standard G1 L1		3" Premium R3 C3		6" Premium S16 S29 C6 T6 R6 M6				Standard G1 L1		3" Premium R3 C3		6" Premium S16 S29 C6 T6 R6 M6													
F028-38x38x32	38" x 38" x 32" 48 lbs.	-	✓	✓	-	-	-	-	-	-	-	-	-	-	-	-	-	-	✓	✓	-	-	-	-	-	-	-	✓

THREE STEP INSIDE CORNER (F035)

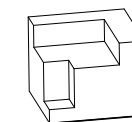

Product No.	Dimen./Weight (L x W x H)	FOOT OPTIONS										INTEGRATED POWER OPTIONS										TFL	Emb.					
		Zip Z	Standard G1 L1		3" Premium R3 C3		6" Premium S16 S29 C6 T6 R6 M6				Standard G1 L1		3" Premium R3 C3		6" Premium S16 S29 C6 T6 R6 M6													
F035-38x38x32	38" x 38" x 32" 46.5 lbs.	-	✓	✓	-	-	-	-	-	-	-	-	-	-	-	-	-	-	✓	✓	-	-	-	-	-	-	-	✓

STRAIGHT RAMP (FK064)

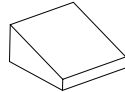

Product No.	Dimen./Weight (L x W x H)	FOOT OPTIONS												INTEGRATED POWER OPTIONS												TFL	Emb.
		Zip Z	Standard G1 L1		3" Premium R3 C3		6" Premium				Standard G1 L1		3" Premium R3 C3		6" Premium												
FK064-20x20x10	20" x 20" x 10" 3 lbs.	✓	-	-	-	-	-	-	-	-	-	-	-	-	-	-	-	-	-	-	-	-	-	✓			

SLAB (FK065)

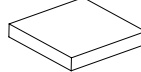

Product No.	Dimen./Weight (L x W x H)	FOOT OPTIONS												INTEGRATED POWER OPTION												TFL	Emb.
		Zip Z	Standard G1 L1		3" Premium R3 C3		6" Premium				Standard G1 L1		3" Premium R3 C3		6" Premium												
FK065-20x20x3	20" x 20" x 3" 1 lb.	✓	-	-	-	-	-	-	-	-	-	-	-	-	-	-	-	-	-	-	-	-	-	✓			

RECTANGLE (FK066)

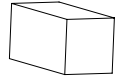

Product No.	Dimen./Weight (L x W x H)	FOOT OPTIONS												INTEGRATED POWER OPTIONS												TFL	Emb.
		Zip Z	Standard G1 L1		3" Premium R3 C3		6" Premium				Standard G1 L1		3" Premium R3 C3		6" Premium												
FK066-16x8x8	16" x 8" x 8" 1 lb.	✓	-	-	-	-	-	-	-	-	-	-	-	-	-	-	-	-	-	-	-	-	-	✓			

STEP (FK067)

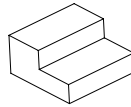

Product No.	Dimen./Weight (L x W x H)	FOOT OPTIONS												INTEGRATED POWER OPTIONS												TFL	Emb.
		Zip Z	Standard G1 L1		3" Premium R3 C3		6" Premium				Standard G1 L1		3" Premium R3 C3		6" Premium												
FK067-20x20x10	20" x 20" x 10" 3 lbs.	✓	-	-	-	-	-	-	-	-	-	-	-	-	-	-	-	-	-	-	-	-	-	✓			

SQUARE (FK068)

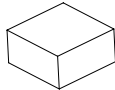

Product No.	Dimen./Weight (L x W x H)	FOOT OPTIONS												INTEGRATED POWER OPTIONS												TFL	Emb.
		Zip Z	Standard G1 L1		3" Premium R3 C3		6" Premium				Standard G1 L1		3" Premium R3 C3		6" Premium												
Small FK068-8x8x4	8" x 8" x 4" .5 lb	✓	-	-	-	-	-	-	-	-	-	-	-	-	-	-	-	-	-	-	-	-	-	✓			
Medium FK068-16x16x8	16" x 16" x 8" 2 lbs.	✓	-	-	-	-	-	-	-	-	-	-	-	-	-	-	-	-	-	-	-	-	-	✓			
Large FK068-20x20x10	20" x 20" x 10" 5 lbs.	✓	-	-	-	-	-	-	-	-	-	-	-	-	-	-	-	-	-	-	-	-	-	✓			

L-STEP (FK069)

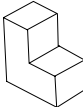

Product No.	Dimen./Weight (L x W x H)	FOOT OPTIONS												INTEGRATED POWER OPTIONS												TFL	Emb.
		Zip Z	Standard G1 L1		3" Premium R3 C3		6" Premium				Standard G1 L1		3" Premium R3 C3		6" Premium												
FK069-16x16x8	16" x 16" x 8" 2 lbs.	✓	-	-	-	-	-	-	-	-	-	-	-	-	-	-	-	-	-	-	-	-	-	✓			

CYLINDER (FK070)

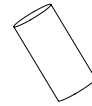

Product No.	Dimen./Weight (Dia x H)	FOOT OPTIONS												INTEGRATED POWER OPTIONS												TFL	Emb.
		Zip Z	Standard G1 L1		3" Premium R3 C3		6" Premium				Standard G1 L1		3" Premium R3 C3		6" Premium												
FK070-8x16	8" x 16" 1 lbs.	✓	-	-	-	-	-	-	-	-	-	-	-	-	-	-	-	-	-	-	-	-	-	✓			

DETAILS

CONSTRUCTION:

- Solid foam construction
- Reinforced seams and stitching
- Made in USA
- Fully zippered (no wood base)
- Backed with a lifetime warranty
- *See page 65

MODIFICATION:

- Stitching and zipper colors
- Embroidery

BUBBA BELUGA (F170)



Bubba Beluga only available in Silvertex Plata

Product No.	Dimen./Weight (L x W x H)	FOOT OPTIONS												INTEGRATED POWER OPTIONS												TFL	Emb.
		Zip Z	Standard G1 L1		3" Premium R3 C3		6" Premium				Standard G1 L1		3" Premium R3 C3		6" Premium												
F170-46x12x21	46" x 12" x 21" 6 lbs.	✓	-	-	-	-	-	-	-	-	-	-	-	-	-	-	-	-	-	-	-	-	-	Bubba Face*			

*Include Bubba Face embroidery in description on purchase order.

DUNCAN DUCK (F171)



Duncan Duck only available in Silvertex Lemoncello

Product No.	Dimen./Weight (L x W x H)	FOOT OPTIONS												INTEGRATED POWER OPTIONS												TFL	Emb.
		Zip Z	Standard G1 L1		3" Premium R3 C3		6" Premium				Standard G1 L1		3" Premium R3 C3		6" Premium												
F171-35x12x28	35" x 12" x 28" 7 lbs.	✓	-	-	-	-	-	-	-	-	-	-	-	-	-	-	-	-	-	-	-	-	-	Duncan Face*			

*Include Duncan Face embroidery in description on purchase order.

ROXY T-REX (F172)



Roxy T-Rex only available in Silvertex Acid

Product No.	Dimen./Weight (L x W x H)	FOOT OPTIONS												INTEGRATED POWER OPTIONS												TFL	Emb.
		Zip Z	Standard G1 L1		3" Premium R3 C3		6" Premium				Standard G1 L1		3" Premium R3 C3		6" Premium												
F172-35x12x33	35" x 12" x 33" 7 lbs.	✓	-	-	-	-	-	-	-	-	-	-	-	-	-	-	-	-	-	-	-	-	-	Roxy Face*			

*Include Roxy Face embroidery in description on purchase order.

BO BRACHO (F173)

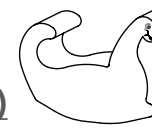

Bo Bracho only available in Silvertex Raspberry

Product No.	Dimen./Weight (L x W x H)	FOOT OPTIONS												INTEGRATED POWER OPTIONS												TFL	Emb.
		Zip Z	Standard G1 L1		3" Premium R3 C3		6" Premium				Standard G1 L1		3" Premium R3 C3		6" Premium												
F173-31x12x23	31" x 12" x 23" 5 lbs.	✓	-	-	-	-	-	-	-	-	-	-	-	-	-	-	-	-	-	-	-	-	-	Bo Face*			

*Include Bo Face embroidery in description on purchase order.

TURBO TRIKE (F174)

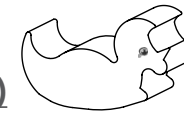

Turbo Trike only available in Silvertex Turquoise

Product No.	Dimen./Weight (L x W x H)	FOOT OPTIONS												INTEGRATED POWER OPTIONS												TFL	Emb.
		Zip Z	Standard G1 L1		3" Premium R3 C3		6" Premium				Standard G1 L1		3" Premium R3 C3		6" Premium												
F174-35.5x12x21.5	35.5" x 12" x 21.5" 5 lbs.	✓	-	-	-	-	-	-	-	-	-	-	-	-	-	-	-	-	-	-	-	-	-	Turbo Face*			

*Include Turbo Face embroidery in description on purchase order.

HUGO HORSE (F175)

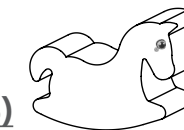

Hugo Horse only available in Silvertex Umber

Product No.	Dimen./Weight (L x W x H)	FOOT OPTIONS												INTEGRATED POWER OPTIONS												TFL	Emb.
		Zip Z	Standard G1 L1		3" Premium R3 C3		6" Premium				Standard G1 L1		3" Premium R3 C3		6" Premium												
F175-30x12x22	30" x 12" x 22" 5 lbs.	✓	-	-	-	-	-	-	-	-	-	-	-	-	-	-	-	-	-	-	-	-	-	Hugo Face*			

*Include Hugo Face embroidery in description on purchase order.

DETAILS

CONSTRUCTION:

- Reinforced seams and stitching
- Fully zippered
- Machine washable cover
- Microsuede textile
- Made in USA
- Backed with a lifetime warranty
- *See page 65

MODIFICATION:

- Microsuede textile color

3' FŌM BEAN BAG (FF003)

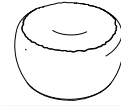

Product No.	Dimen./Weight (L x W x H)	FOOT OPTIONS						INTEGRATED POWER OPTIONS												TFL	Emb.				
		Zip Z	Standard		3" Premium		6" Premium		Standard		3" Premium		6" Premium		6" Premium										
			G1	L1	R3	C3	S16	S29	C6	T6	R6	M6	G1	L1	R3	C3	S16	S29	C6	T6	R6	M6			
FF003	36" x 36" x 24" 20 lbs.	✓	-	-	-	-	-	-	-	-	-	-	-	-	-	-	-	-	-	-	-	-	-	-	-

4' FŌM BEAN BAG (FF004)

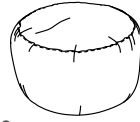

Product No.	Dimen./Weight (L x W x H)	FOOT OPTIONS						INTEGRATED POWER OPTIONS												TFL	Emb.				
		Zip Z	Standard		3" Premium		6" Premium		Standard		3" Premium		6" Premium		6" Premium										
			G1	L1	R3	C3	S16	S29	C6	T6	R6	M6	G1	L1	R3	C3	S16	S29	C6	T6	R6	M6			
FF004	48" x 48" x 31" 45 lbs.	✓	-	-	-	-	-	-	-	-	-	-	-	-	-	-	-	-	-	-	-	-	-	-	-

5' FŌM LOUNGER (FF017)



Product No.	Dimen./Weight (L x W x H)	FOOT OPTIONS						INTEGRATED POWER OPTIONS												TFL	Emb.				
		Zip Z	Standard		3" Premium		6" Premium		Standard		3" Premium		6" Premium		6" Premium										
			G1	L1	R3	C3	S16	S29	C6	T6	R6	M6	G1	L1	R3	C3	S16	S29	C6	T6	R6	M6			
FF017	60" x 48" x 48" 60 lbs.	✓	-	-	-	-	-	-	-	-	-	-	-	-	-	-	-	-	-	-	-	-	-	-	-

6' FŌM LOUNGER (FF012)



Product No.	Dimen./Weight (L x W x H)	FOOT OPTIONS						INTEGRATED POWER OPTIONS												TFL	Emb.				
		Zip Z	Standard		3" Premium		6" Premium		Standard		3" Premium		6" Premium		6" Premium										
			G1	L1	R3	C3	S16	S29	C6	T6	R6	M6	G1	L1	R3	C3	S16	S29	C6	T6	R6	M6			
FF012	72" x 48" x 48" 70 lbs.	✓	-	-	-	-	-	-	-	-	-	-	-	-	-	-	-	-	-	-	-	-	-	-	-

7' FŌM LOUNGER (FF013)



Product No.	Dimen./Weight (L x W x H)	FOOT OPTIONS						INTEGRATED POWER OPTIONS												TFL	Emb.				
		Zip Z	Standard		3" Premium		6" Premium		Standard		3" Premium		6" Premium		6" Premium										
			G1	L1	R3	C3	S16	S29	C6	T6	R6	M6	G1	L1	R3	C3	S16	S29	C6	T6	R6	M6			
FF013	84" x 48" x 48" 85 lbs.	✓	-	-	-	-	-	-	-	-	-	-	-	-	-	-	-	-	-	-	-	-	-	-	-



PRODUCTS PICTURED:
LIL EXPLORERS PIECES
TEXTILES PICTURED:
SILVERTEX



PRODUCTS PICTURED:
HEX NEST
ANDERSON CHAIR
TEXTILES PICTURED:
SILVERTEX
LINETTE
BIG DOT



PRODUCTS PICTURED:
MEDIA CHAIR
TEXTILES PICTURED:
BOBBY
SILVERTEX



PRODUCTS PICTURED:
LILY PAD
TEXTILES PICTURED:
CONVO DOODLE

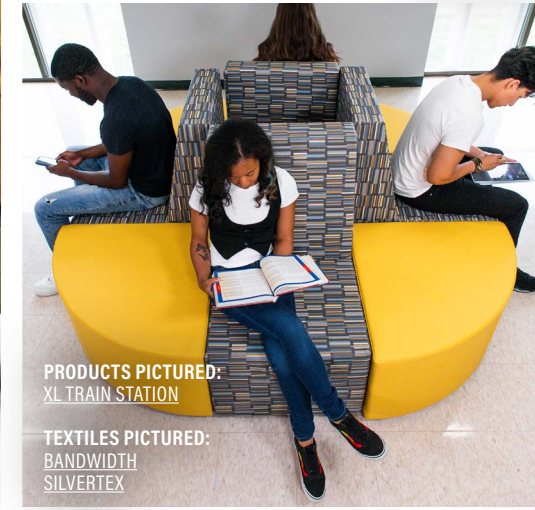

PRODUCTS PICTURED:
XL TRAIN STATION
TEXTILES PICTURED:
BANDWIDTH
SILVERTEX









PRODUCTS PICTURED:
ROCK'N ROLLER
TEXTILES PICTURED:
ROUTE



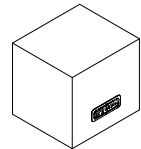

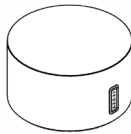

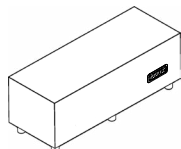
PRODUCTS PICTURED:
DUNCAN DUCK
BO BRACO
TEXTILES PICTURED:
SILVERTEX

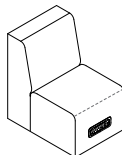
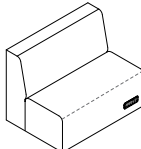
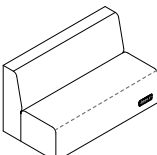

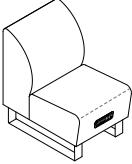
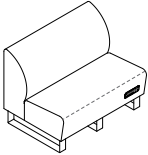
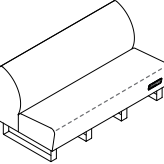
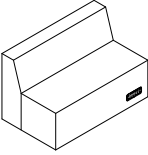
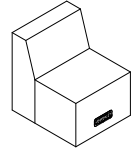
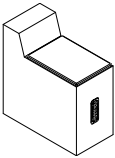
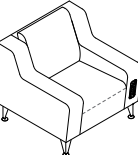
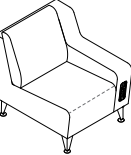
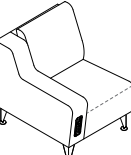
PRODUCTS PICTURED:
LINEAR REFRESH CHAIR
TEXTILES PICTURED:
SILICA CUSP
SILICA

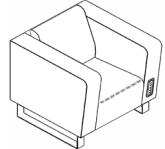
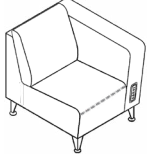
Product Name	Standard Power Location
F001-18x18 Rectangle Ottoman	
F001-31x31 Rectangle Ottoman	
F005-30 Round Ottoman	
F005-36 Round Ottoman	
F009 Bench 48	
F015 Arc Bench 60	
F016 Linear Chair	
F017 Linear Loveseat	
F019 Linear Sofa	

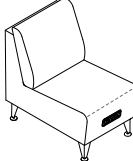
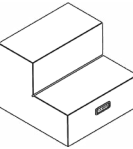
Product Name	Standard Power Location
F139 Linear Refresh Chair	
F140 Linear Refresh Loveseat	
F141 Linear Refresh Sofa	
F133 Connect Low Back Sofa	
F135 Connect Low Back Chair	
F138 Connect Low Back Table	
F150 Low Arm Club Social Chair	
F151 Low Arm Left Social Chair	
F152 Low Arm Right Social Chair	

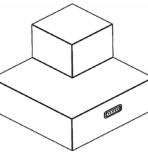
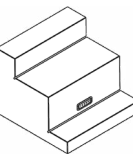
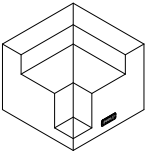
Product Name	Standard Power Location
F050 Club Social Chair	
F051 Left Social Chair	
F052 Right Social Chair	
F053 Armless Social Chair	
F027 Two Step	
F029 Two Step Inside Corner	
F030 Two Step Outside Corner	
F028 Three Step	
F035 Three Step Inside Corner	

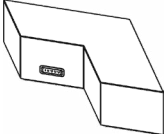
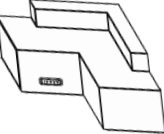
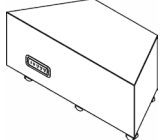
Product Name	Standard Power Location
F113 Boomerang Bench	
F123 Boomerang Sofa	
F115 Trapezoid Bench	



TEXTILES PICTURED: XXXXXXXX



CUSTOMER SERVICE

INFORMATION & MORE

PURCHASE ORDERS

Be sure to include:

1. Quantity
2. SKU Number
3. Description
4. Pattern name and color choice
5. Color guide for items requiring one
6. Price for each item

Fōmcore accepts orders via:

- Email: sales@fomcore.com
- Contact your regional sales director

Modification of orders must be submitted to Fōmcore in writing within 48 hours of initial sales order acknowledgment. In some cases, a change order fee may be charged if work is in progress or custom products are involved.

TERMS

Invoice terms for credit accounts are Net 30 days. Orders are invoiced on day of shipment. New customers and international customers are cash in advance.

SHIPPING - LEAD TIMES

All furniture is made to order. Shipping date is confirmed upon receipt of order. Every attempt will be made to meet that shipping date, however, it is subject to change without prior notification. Fōmcore reserves the right to discontinue products and change product specifications and prices. Fōmcore delivers to all 48 contiguous states. All orders delivering to other states and international locations are FOB Muskegon (zip code 49442), Michigan.

WARRANTY

Product manufactured by Fōmcore is warranted to be free of defects in material and workmanship under normal use for the lifetime of the product, unless otherwise noted.* Product must be properly cared for, maintained, and in use by its original owner. This warranty is non-transferrable, and damage/defects that occur in transit or by acts negligence, abuse, abnormal usage, misuse, accidents, or alterations nullify the warranty. Conditions resulting from the normal aging and wear of textile(s), filling material(s), and finish(es) are excluded from this warranty. As Buyer's sole remedy under this warranty, Fōmcore, at its option, will credit, repair, or replace damaged product at no charge to the original owner of record provided the replacement or return has previously been authorized by Fōmcore under terms of this warranty. It is expressly agreed that this remedy of repair, replacement, or credit, at Fōmcore's option, is Buyer's exclusive remedy under this warranty. This warranty is non-transferrable. In no event shall Fōmcore be liable for consequential damages.

**Weather resistant product is warranted for three (3) years from the date of product shipment.*

GET IN TOUCH WITH OUR REGIONAL DIRECTORS



Dave Diller
REGIONAL DIRECTOR - WEST
PHONE: 231.366.4791 x319
DIRECT: 231.246.1536
EMAIL: dave@fomcore.com



Mark Gardner
REGIONAL DIRECTOR - MIDWEST/CANADA
PHONE: 231.366.4791 x321
DIRECT: 231.246.4564
EMAIL: mark@fomcore.com

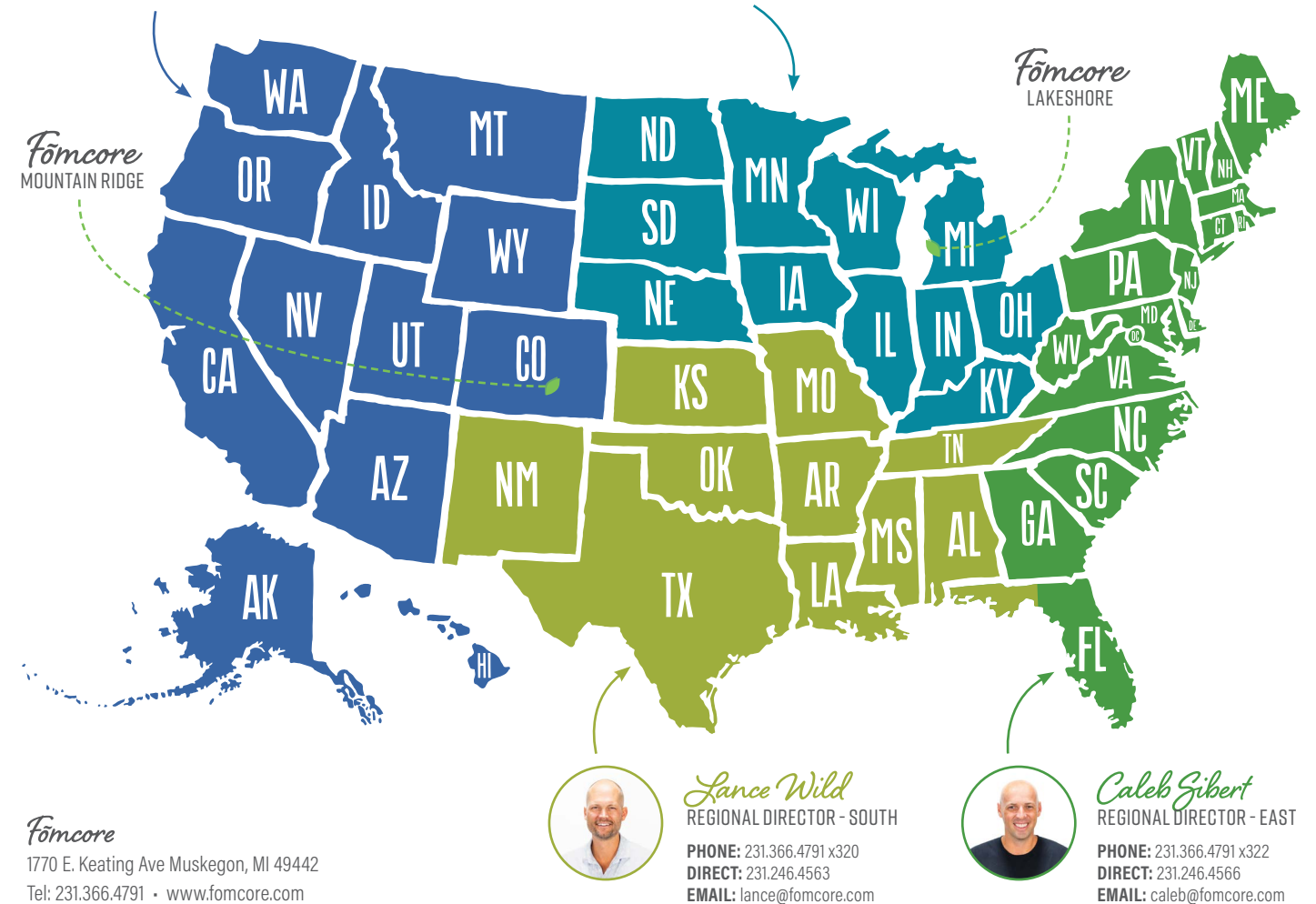

Fōmcore
1770 E. Keating Ave Muskegon, MI 49442
Tel: 231.366.4791 • www.fomcore.com



Lance Wild
REGIONAL DIRECTOR - SOUTH
PHONE: 231.366.4791 x320
DIRECT: 231.246.4563
EMAIL: lance@fomcore.com



Caleb Gibert
REGIONAL DIRECTOR - EAST
PHONE: 231.366.4791 x322
DIRECT: 231.246.4566
EMAIL: caleb@fomcore.com

OUR COMMITMENT TO THE ENVIRONMENT AND SUSTAINABILITY

As the foam experts, our unique foam life cycle represents our continued commitment to the care and health of our environment and customers.

Our shop begins with selecting high quality materials to produce your customizable pieces. One of our steps in eliminating ALL waste is efficiently cutting into the foam into the shapes and sizes. The excess from

our Amoebas, Rounds, and Lily Pads, for example, is shredded and recycled for products such as carpet padding and insulation.

An additional way we care about you and our environment includes exceeding the expectations and standards in the furniture industry. We earned the Clean Air Gold Certification for our foam and fabric. This means our products have been independently tested by industry leaders for emissions into the ambient air. What does this mean for you? You can breathe easy in your workplace.





FOSTERING
CONNECTION
& **BELONGING**
IN EVERY SPACE

PRODUCTS PICTURED:
HUG CHAIR 2.0

TEXTILES PICTURED:
SILVERTEX